



EXPONIO
SURGICAL INSTRUMENTS



We are pleased to introduce ourselves as a manufacturer and exporters of high and standard quality Surgical, Dental and Beauty Instruments based in the Historical city of Sialkot – Pakistan enriched with the uniquely skilled workforce having generations of manufacturing experience.

Percussion Hammers and Aesthesiometers



01-101
TROEMNER
Size: 245 mm

1/2



01-102
DEJERINE
Size: 200 mm

1/2



01-103
DEJERINE
with needle
Size: 210 mm

1/2



01-104
TAYLOR
Size: 195 mm

1/2



01-105
BERLINER
Size: 200 mm

1/2

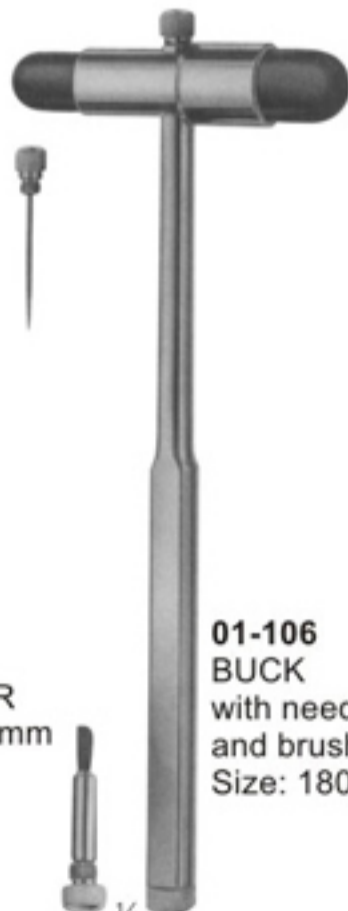

01-106
BUCK
with needle
and brush
Size: 180 mm

1/2



01-107
RABINER
with needle
and brush
Size: 255 mm

1/2



01-108
ALY
Size: 190 mm

1/2



01-109
WARTENBERG
Pinwheel for
neurological
examination
Size: 185 mm

1/2

Stethoscopes



01-110
PINARD (Aluminum)
Size: 155 mm



01-111
wooden
Size: 145 mm



01-112
BOWLES
Stethoscope
with diaphragm



01-113
ANESTOPHON



01-114
FORD-BOWLES
Dual chest piece
with two outlets



01-115
BOWLES

Head Mirrors and Head Bands

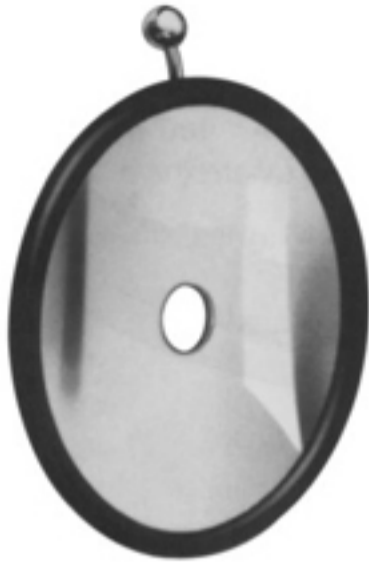

01-116
ZIEGLER \varnothing 90mm
head mirror only
with rubber coating

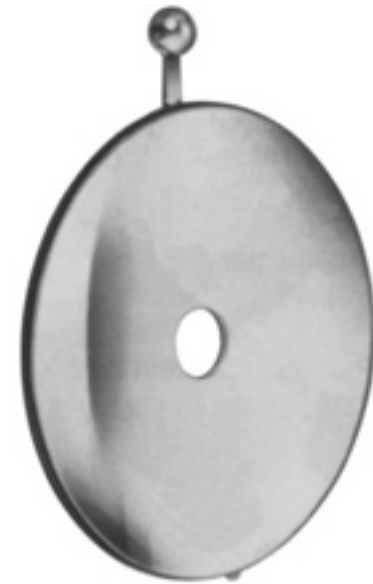

01-117
ZIEGLER \varnothing 90mm
head mirror only
with metal coating



01-118
ZIEGLER
head band of plastic black

01-119
ZIEGLER
head band of plastic white

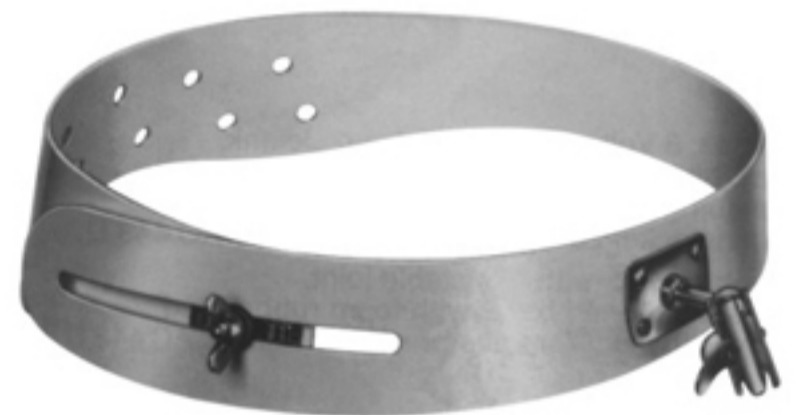

01-120
MURPHY
head band of celluloid, white



01-121
head band of plastic,
white, soft pattern



01-122
head mirror with black
plastic head band.

Tongue Depressors

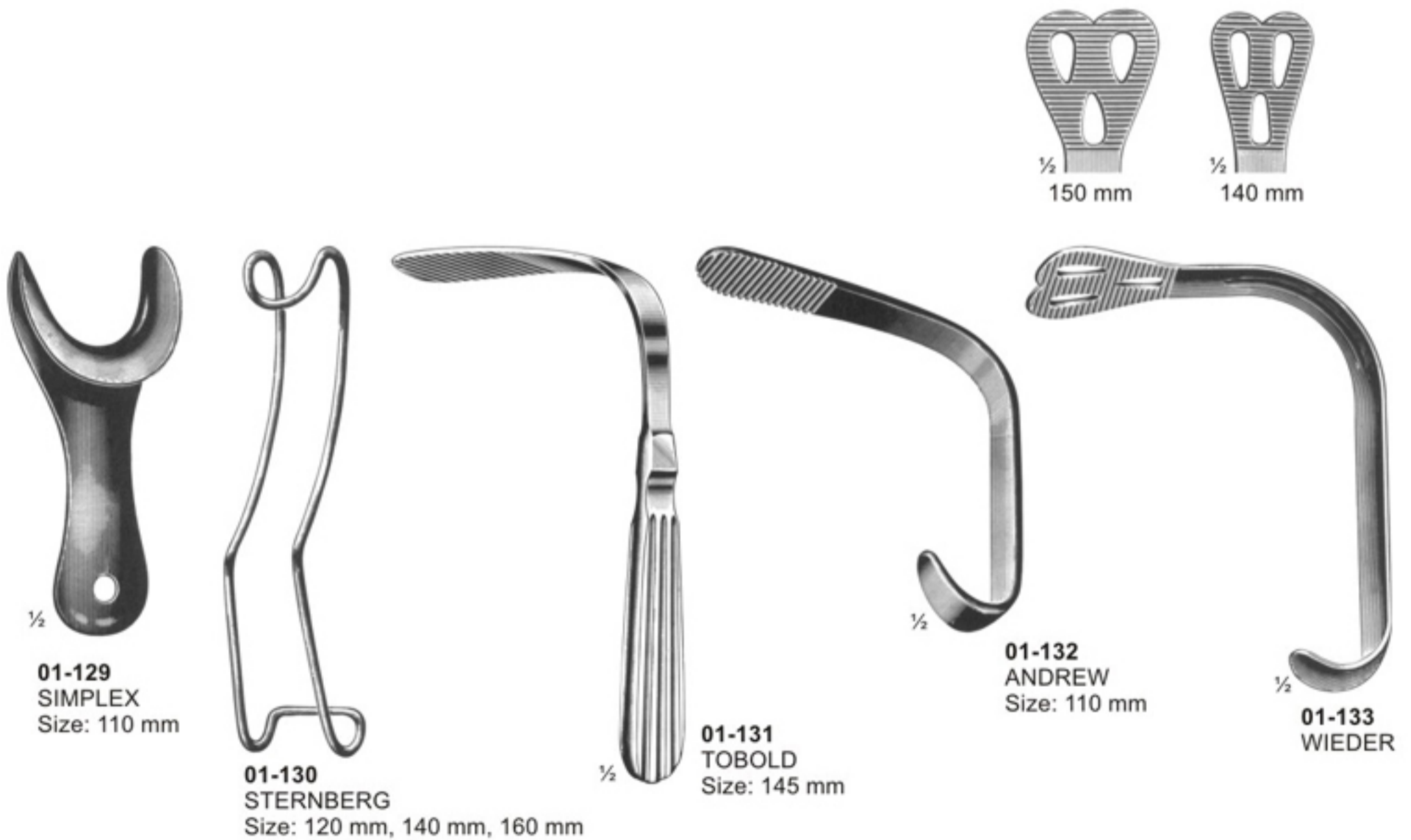
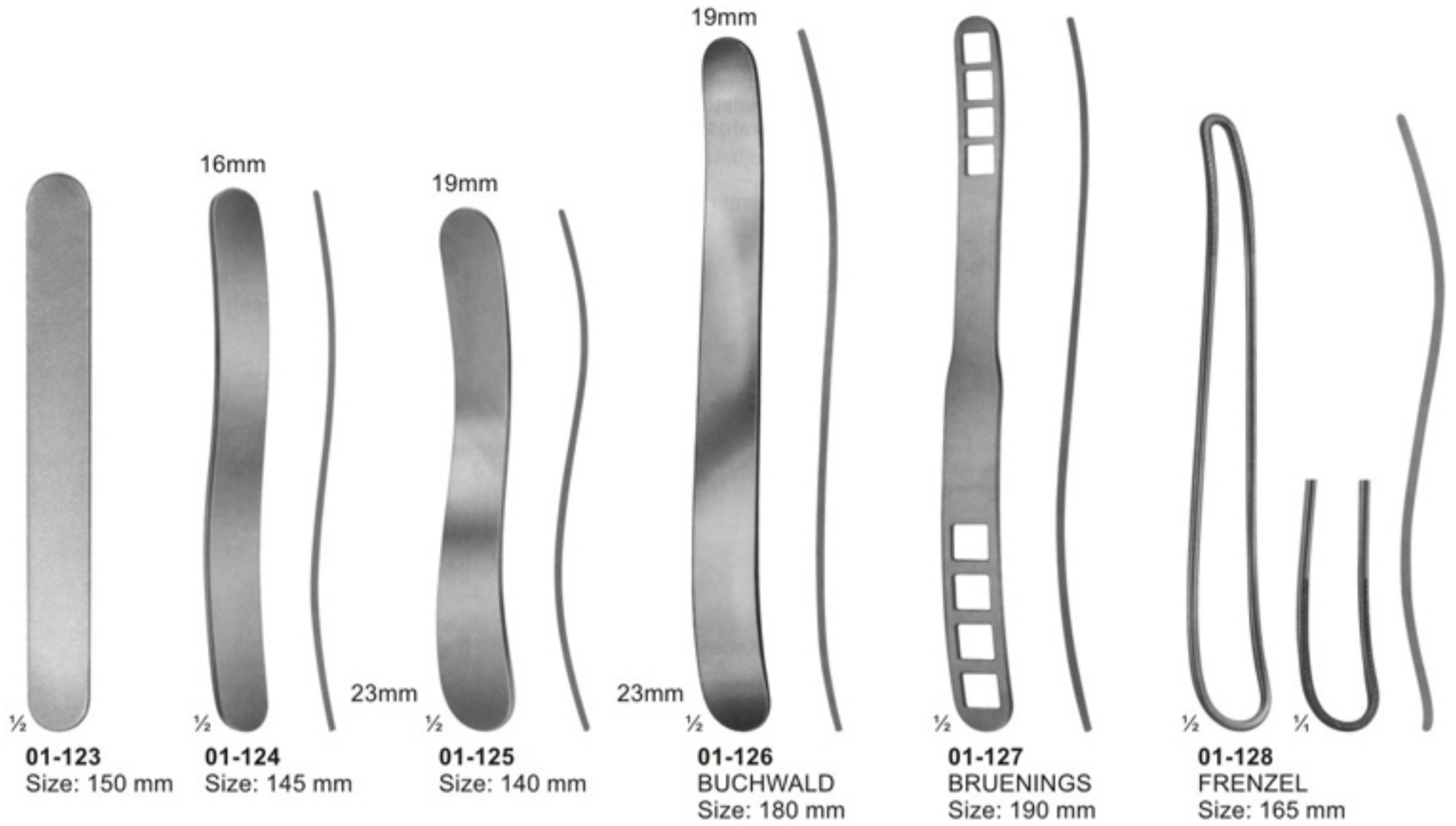

Instruments for Anaesthesia and Tongue Forceps



½

01-134
SCHIMMELBUSCH
Ether mask



½

01-135
HEISTER
Mouth gag
Size: 130 mm



½

01-136
FERGUSSON-ACKLAND
Mouth gag
Size: 145 mm



½

01-137
DENHARDT
Mouth gag with silicon
inserts, interchangeable
Size: 125 mm



½

01-138
ROSER KOENIG
Mouth gag
Size: 160 mm, 185 mm

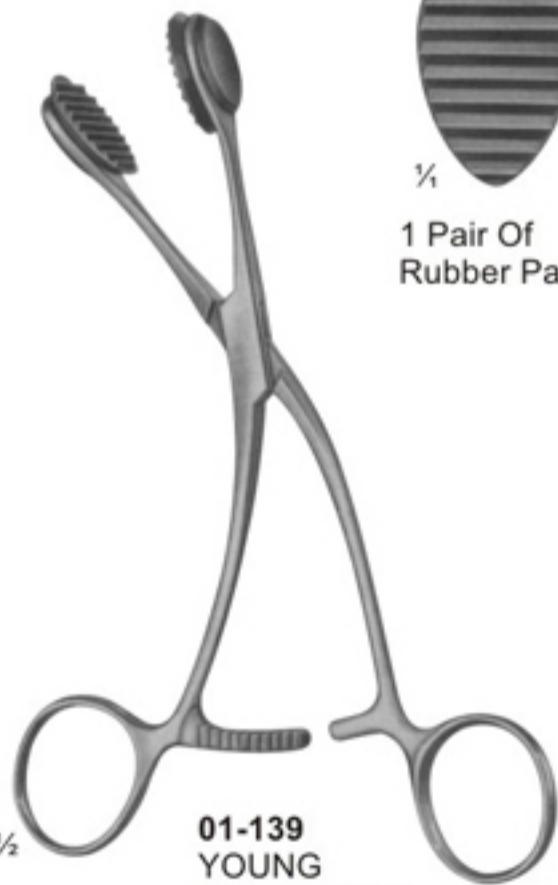

½

01-139
YOUNG
Size: 165 mm



¼

1 Pair Of
Rubber Pads

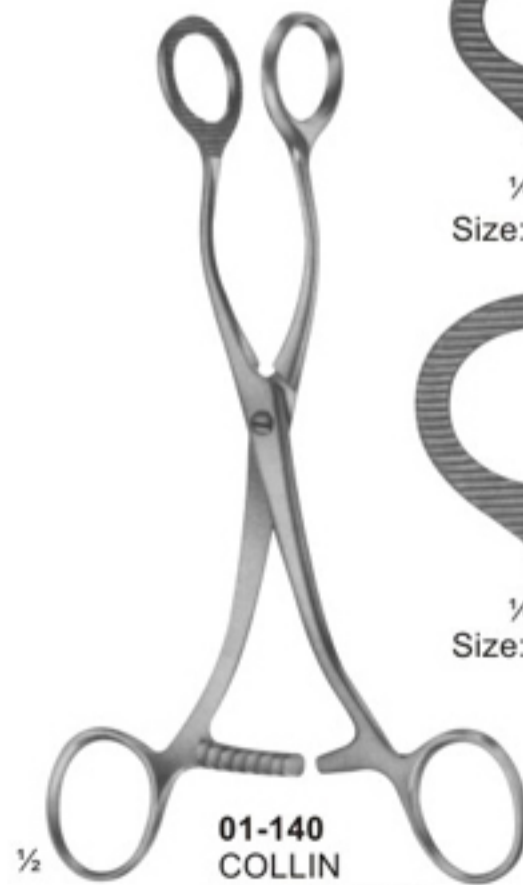

½

01-140
COLLIN
Size: 160 mm,
170 mm



¼

Size: 160 mm



¼

Size: 170 mm

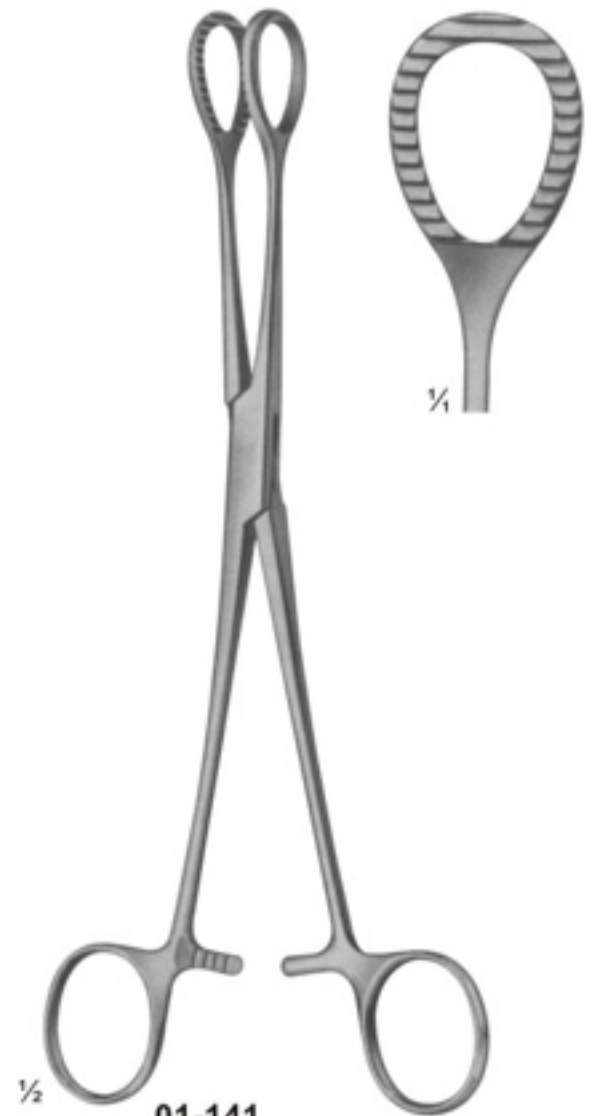

½

01-141
HEYWOOD-SMITH
modif. Size: 215 mm

Blood Lancets and Laryngeal Mirrors

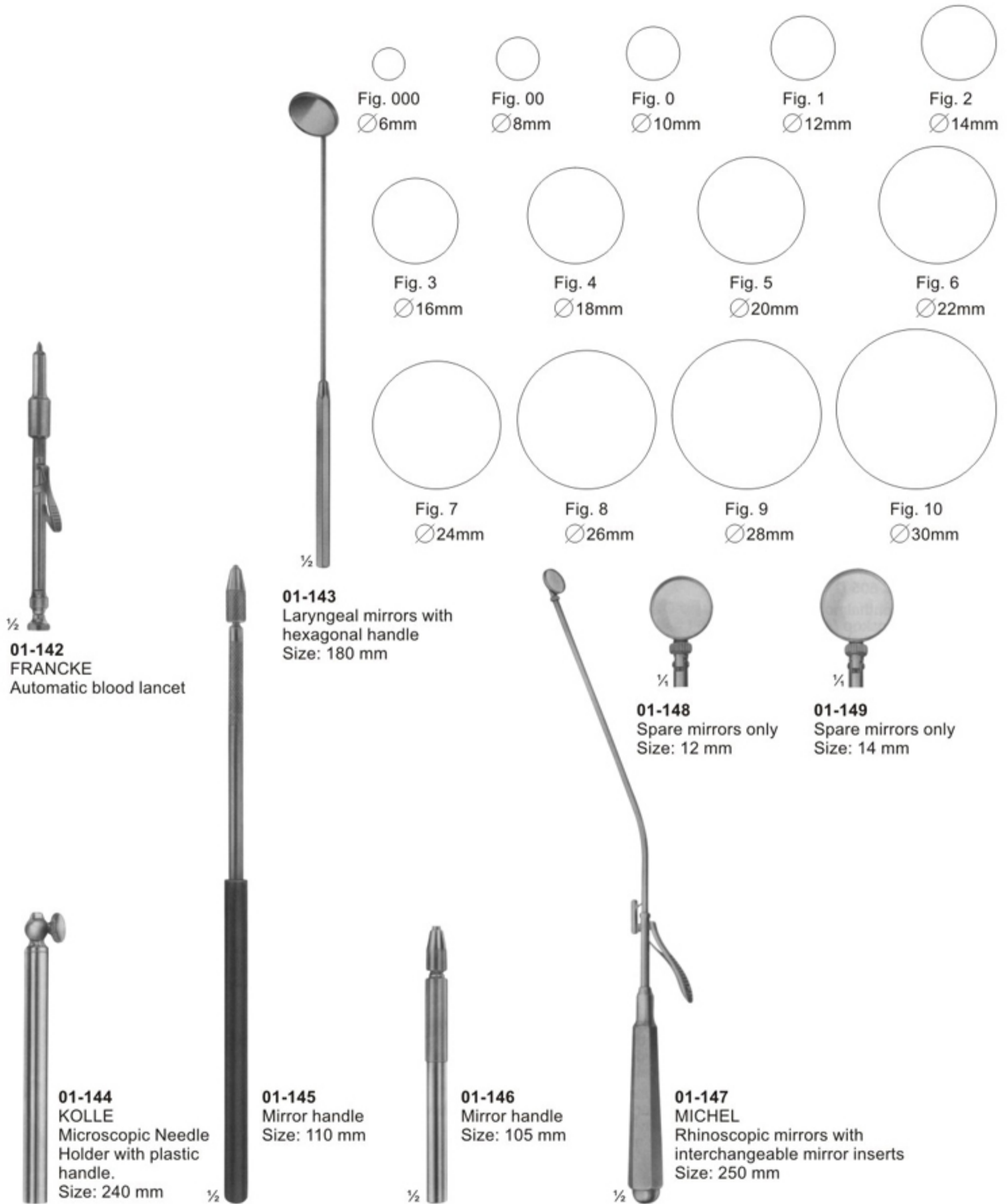

Laryngoscope and Diagnostic Sets



01-150
Infants
Size: 150 mm



01-151
Children
Size: 200 mm



01-152
Adults
Size: 250 mm



01-154



01-150 - 152
MAGILL



01-153
Medium battery handle
only, 25 mm diam.



01-153-A
Spare bulb
2.7 volt, for
otoscopes



01-153-B
Spare bulb
2.6 volt, for
ophthalmoscopes



01-155



01-156
Otoscope set, consists of
battery handle without batteries,
3 ear specula, 1 bulb in valvet lined case



01-157
Diagnostic set, otoscope with three specula,
nasal speculum, lamp holder, two laryngeal
mirrors, tongue blade holder

Laryngoscopes



1/3

**01-158
MILLER**
Laryngoscope set, consists of battery handle (without battery)
with four miller laryngoscope blades

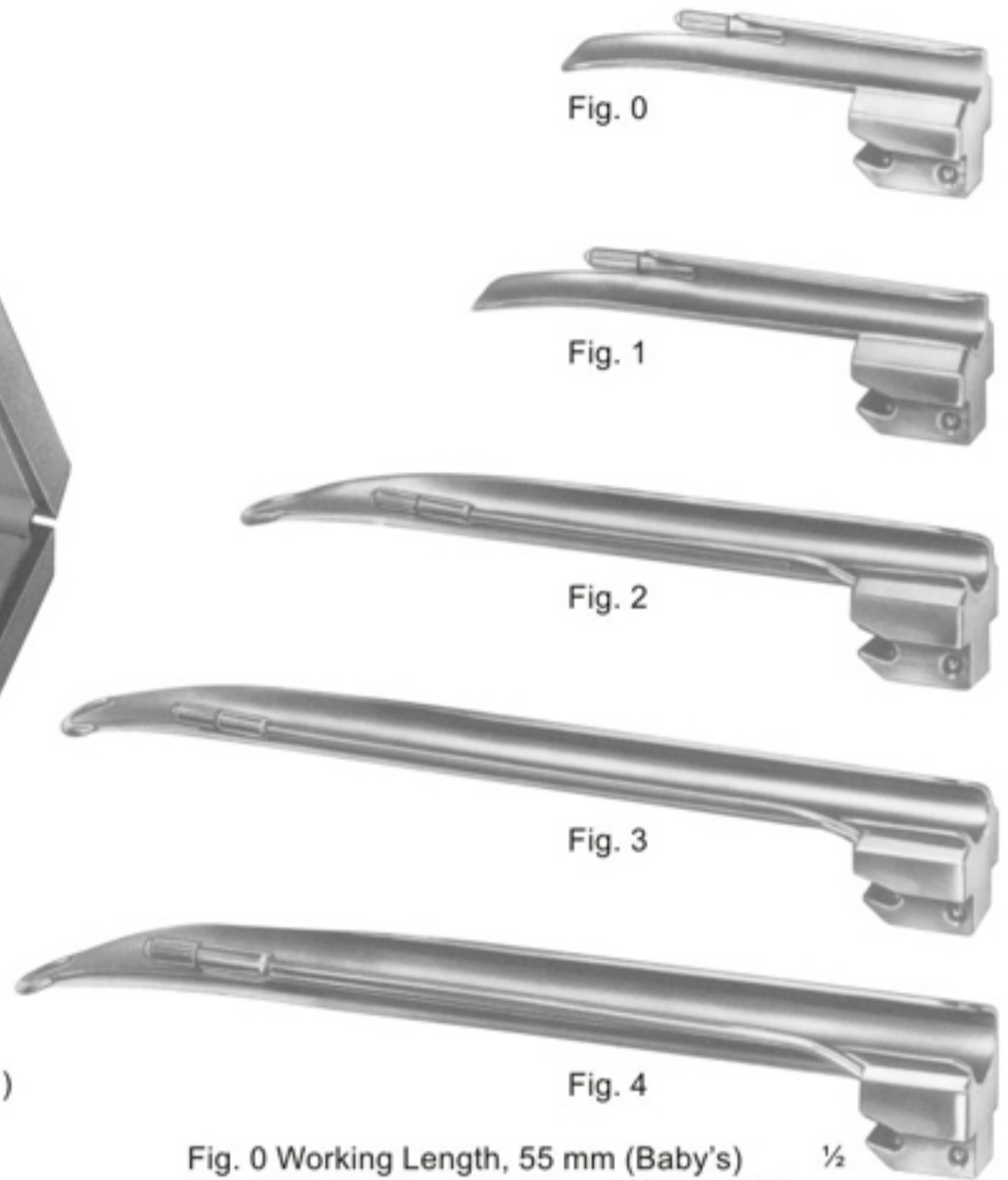

Fig. 0 Working Length, 55 mm (Baby's) 1/2
Fig. 1 Working Length, 80 mm (Children's)
Fig. 2 Working Length, 130 mm (Adolescent's)
Fig. 3 Working Length, 170 mm (Women's)
Fig. 4 Working Length, 180 mm (Men's)



1/3

**01-159
GUEDEL-NEGUS**
Laryngoscope set, consists of battery handle (without battery)
with four miller laryngoscope blades

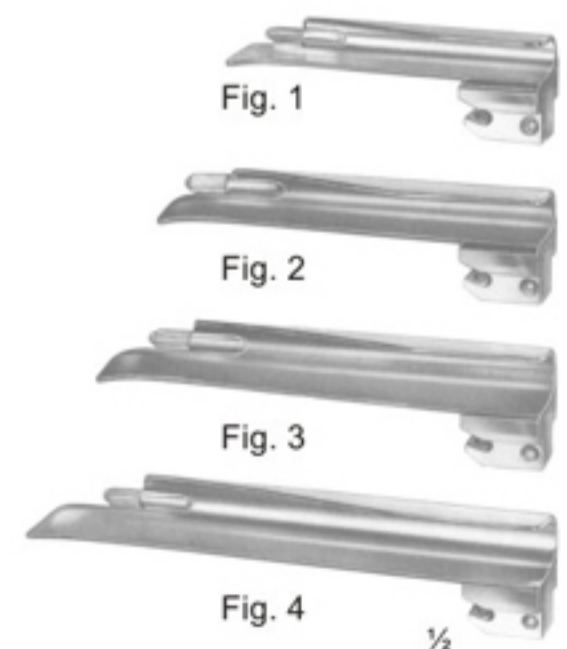

Fig. 1 Working Length, 70 mm (Children's)
Fig. 2 Working Length, 90 mm (Adolescent's)
Fig. 3 Working Length, 110 mm (Women's)
Fig. 4 Working Length, 135 mm (Men's) 1/2

Laryngoscopes



01-160
McINTOSH
Laryngoscope Set, Consists Of Battery Handle (Without Battery)
With Three McIntosh Blades, Fig. 1, Fig. 2, Fig. 3

01-161
McINTOSH
Laryngoscope Set, Consists Of Battery Handle (Without Battery)
With Five McIntosh Blades, Fig. 0, Fig. 1, Fig. 2, Fig. 3, Fig. 4



Fig. 0



Fig. 1



Fig. 2

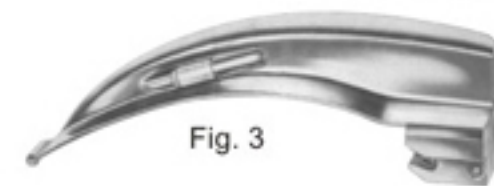

Fig. 3



Fig. 4

01-161 A Fig. 0 Working Length, 55 mm (Baby's)
01-161 B Fig. 1 Working Length, 75 mm (Children's)
01-161 C Fig. 2 Working Length, 90 mm (Adolescent's)
01-161 D Fig. 3 Working Length, 110 mm (Women's)
01-161 E Fig. 4 Working Length, 135 mm (Men's)

01-162
FOREGGER
Laryngoscope Set, Consists Of
Battery Handle (Without Battery)
With Three Foregger Blades,
Fig. 1, Fig. 2, Fig. 3,



01-163
FOREGGER
Laryngoscope Set, Consists Of
Battery Handle (Without Battery)
With Four Foregger Blades,
Fig. 1, Fig. 2, Fig. 3, Fig. 4,



Fig. 1



Fig. 2



Fig. 3

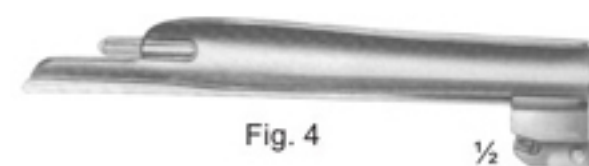

Fig. 4

01-162 A Fig. 1 Working Length, 70 mm (Children's)
01-162 B Fig. 2 Working Length, 90 mm (Adolescent's)
01-162 C Fig. 3 Working Length, 110 mm (Women's)
01-162 D Fig. 4 Working Length, 135 mm (Men's)



01-164
Fiber Optic
Battery Handle
30mm diam.



01-165
Fiber Optic
Battery Handle
18mm diam.



01-166
Replacement Lamp
(Krypton) 2.5 V



01-167
Replacement Lamp
(Halogen) 2.5 V

Examination & Measuring Instruments

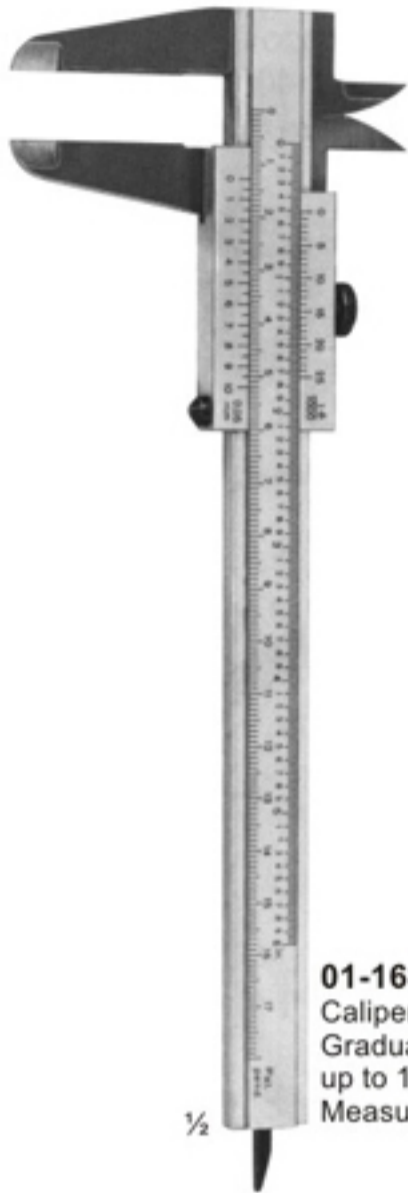

01-168
Caliper Of Aluminium
Graduated in mm & inches
up to 180mm
Measuring Range up to 139mm



01-169
VERNIER
Universal Caliper Of Steel
Graduated in mm & inches
up to 180mm
Measuring Range up to 120mm
with Vernier in 1/10mm & 1/16"

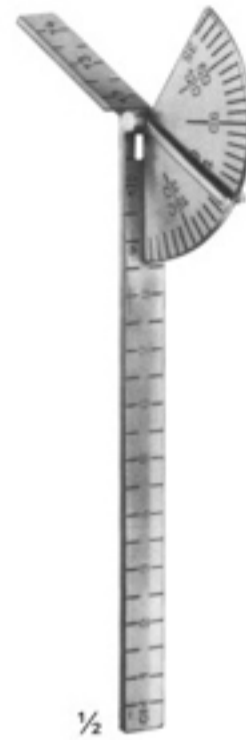

01-170
CARROLL
Size: 145 mm
Finger Goniometer



01-171
TOWNLEY
Graduated in
mm & inches
Size: 115 mm



01-172
COLLIN
Druck Pressure 72 kg
Size: 125 mm



01-173
BERTILLON
Caliper For Measuring The Head
Size: 320 mm



01-174
CASTROVIEJO
Caliper
Size: 75mm



01-175
MOLTGEN
Goniometer



01-176
Size: 150 mm



01-177
Size: 500 mm

Dissecting Knives



$\frac{1}{2}$
02-101 - 110
Fig. 1 - 10



$\frac{1}{4}$
02-101
Fig. 1
30 mm



02-102
Fig. 2
36 mm



02-103
Fig. 3
40 mm



02-104
Fig. 4
45 mm



02-105
Fig. 5
50 mm



$\frac{1}{4}$
02-106
Fig. 6
27 mm



02-107
Fig. 7
35 mm



02-108
Fig. 8
40 mm



02-109
Fig. 9
47 mm



02-110
Fig. 10
50 mm

Amputating Knives, Cartilage Knives and Autopsy Knives



LISTON
02-111
 Size: 130 mm
02-112
 Size: 160 mm
02-113
 Size: 190 mm
02-114
 Size: 200 mm

02-115
 CATLIN
 Size: 160 mm
 Blade length
 Amputating
 Knives

02-116
 LANGENBECK
 Size: 120 mm
 Blade length
 Flap Knives

02-117
 Size: 110 mm
 Blade length
 Interosseous
 Knives

02-118
 Size: 55 mm
 Blade length
 with raspatory,
 Wooden handle

02-119
 Size: 70 mm
 Blade length
 Wooden handle

02-120
 Size: 80 mm
 Blade length
 Metal handle

02-121
 Size: 195 mm
 Blade length
 Metal handle

Blade length
 Amputating Knives

Cone Knives, Myomatome, Trigeminal and Tonsil Knives



02-122
AYRE
Size: 235 mm
Cone Knife

02-123
Size: 230 mm
Cone Knife

02-124
SEGOND
Size: 270 mm
Myomatome

02-125
OLIVECRONA
Size: 205 mm
Trigeminal
Knife

02-126
Size: 230 mm
Trigeminal
Knife

02-127
FOWLER
Size: 200 mm
Tonsil Knife

02-128
ABRAHAM
Size: 215 mm
Tonsil Knife

02-129
BRUNINGS
Size: 215 mm
Tonsil Knife

Scalpel Handles

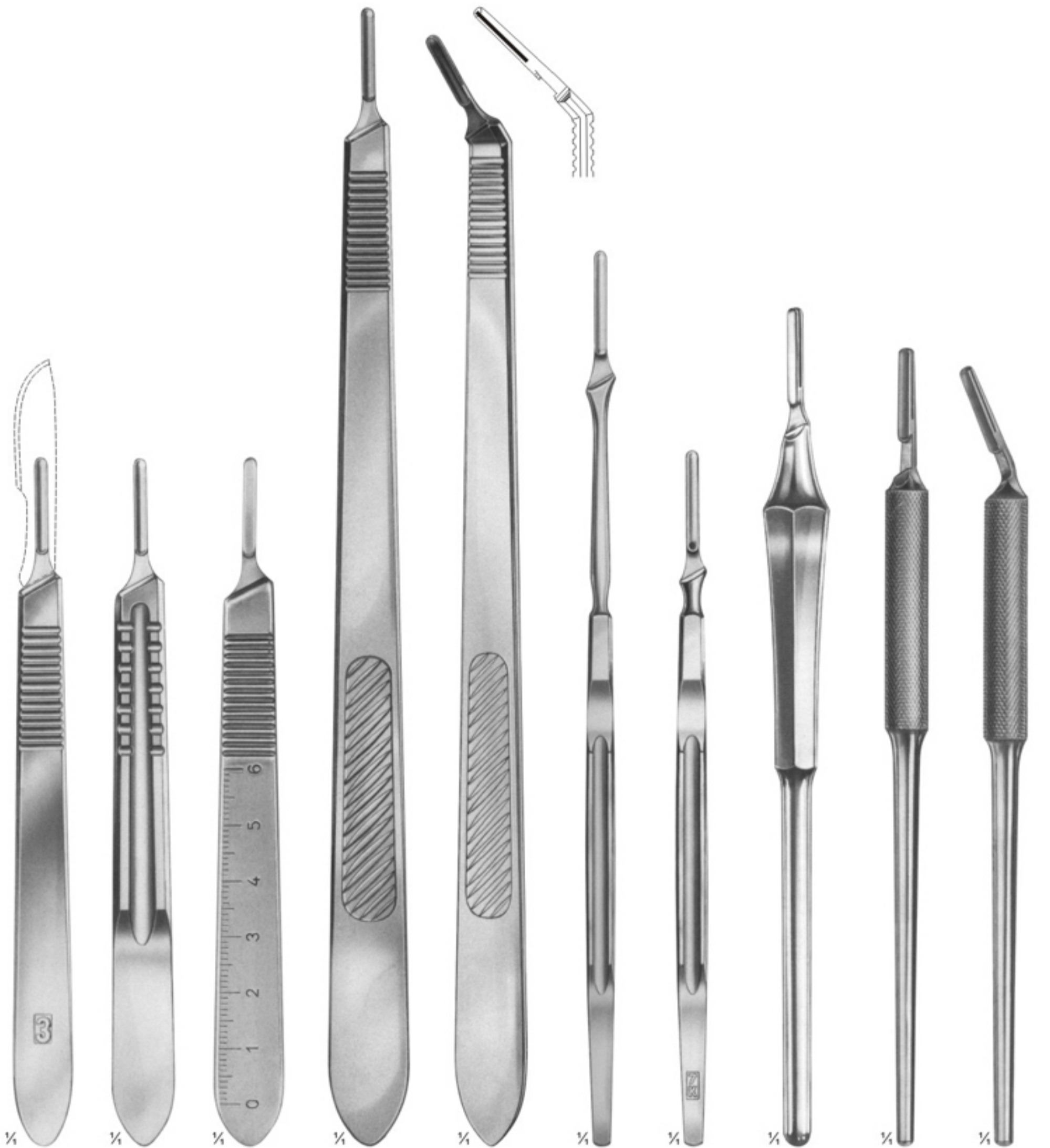

$\frac{1}{4}$	$\frac{1}{4}$	$\frac{1}{4}$	$\frac{1}{4}$	$\frac{1}{4}$	$\frac{1}{4}$	$\frac{1}{4}$	$\frac{1}{4}$	$\frac{1}{4}$	$\frac{1}{4}$
02-130 STANDARD No. 3 Solid 12 cm	02-131 No. 3 Solid 12 cm	02-132 No. 3 Solid 12 cm	02-133 No. 3 L Straight Solid 21.5 cm	02-134 No. 3 L Angled Solid 21 cm	02-135 No. 7 Solid 16 cm	02-136 No. 7 K Solid 12.5 cm	02-137 Hollow-Round 15.5 cm	02-138 No. 3 Straight Solid, Round 14.5 cm	02-139 No. 3 Angled Solid, Round 14 cm

Micro Scissors (Spring Type) with Flat Handles

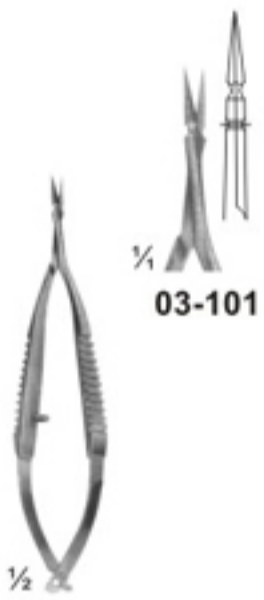

03-101 - 103
VANNAS
Size: 85 mm



03-104 - 105
CASTROVIEJO
Size: 95 mm

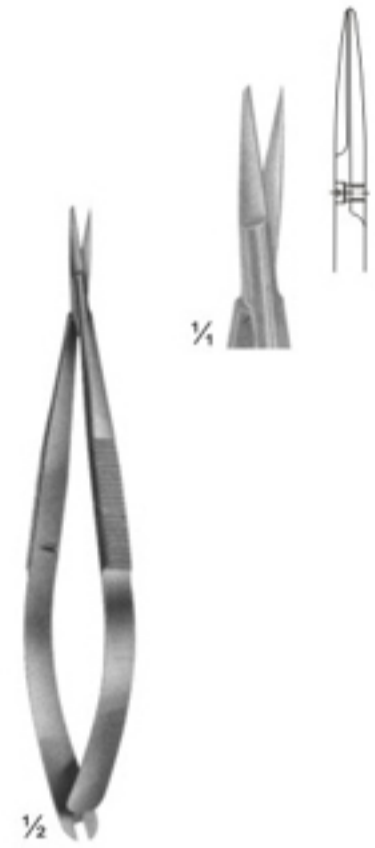

03-106
NOYES
Size: 125 mm

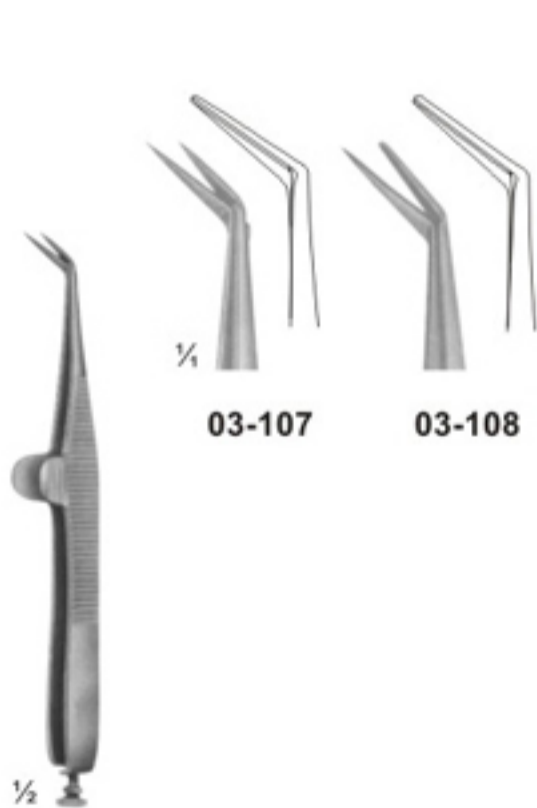

03-107 - 108
WECKER
Eye scissor
Size: 110 mm



03-109
CASTROVIEJO
Eye scissor
Size: 115 mm

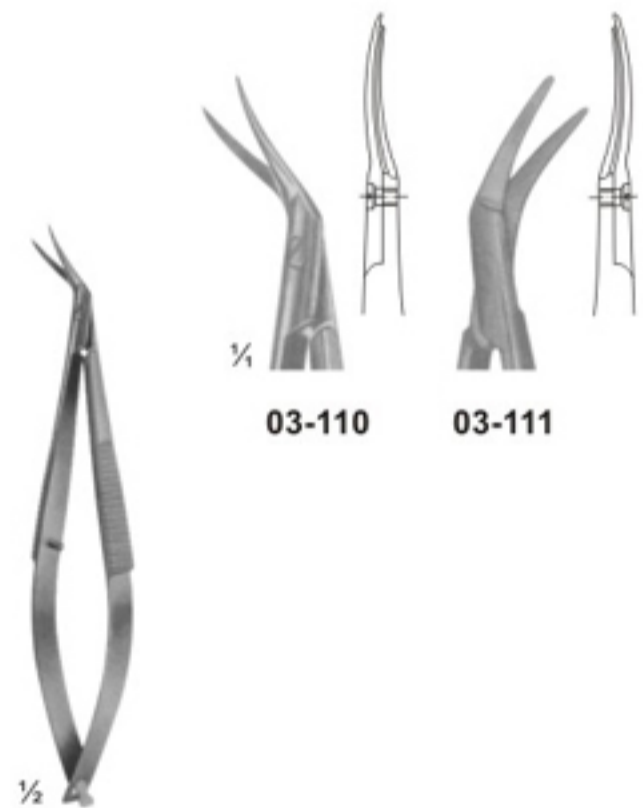

03-110 - 111
CASTROVIEJO
Eye scissor
Size: 110 mm

Micro Scissors (Spring Type) with Flat Handles

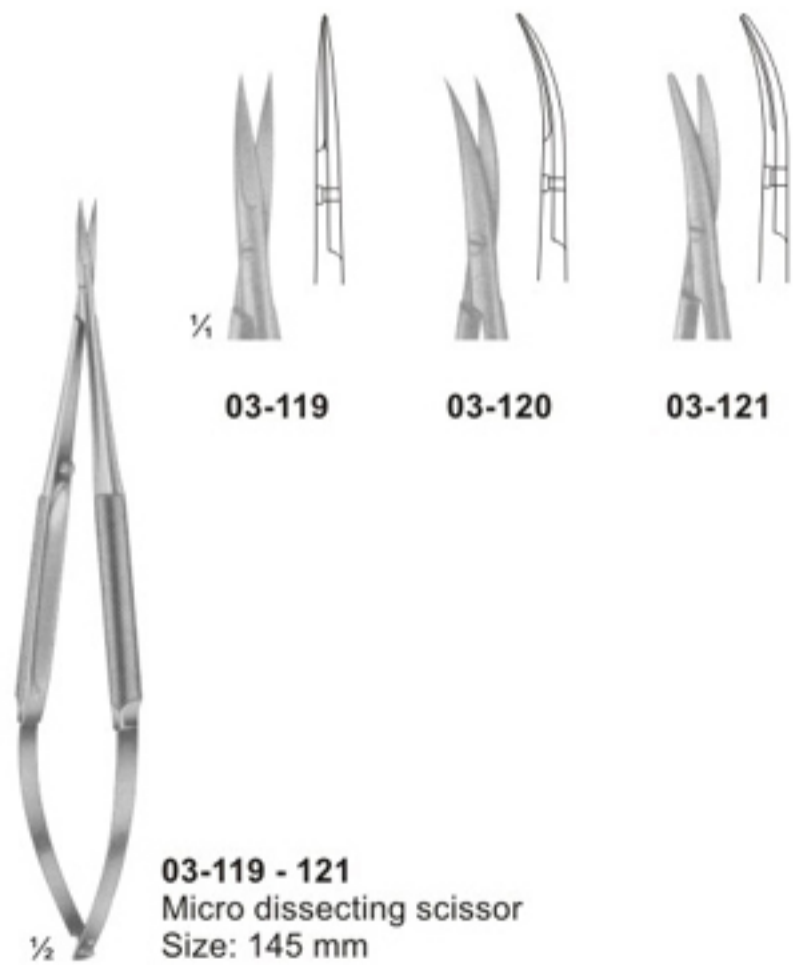
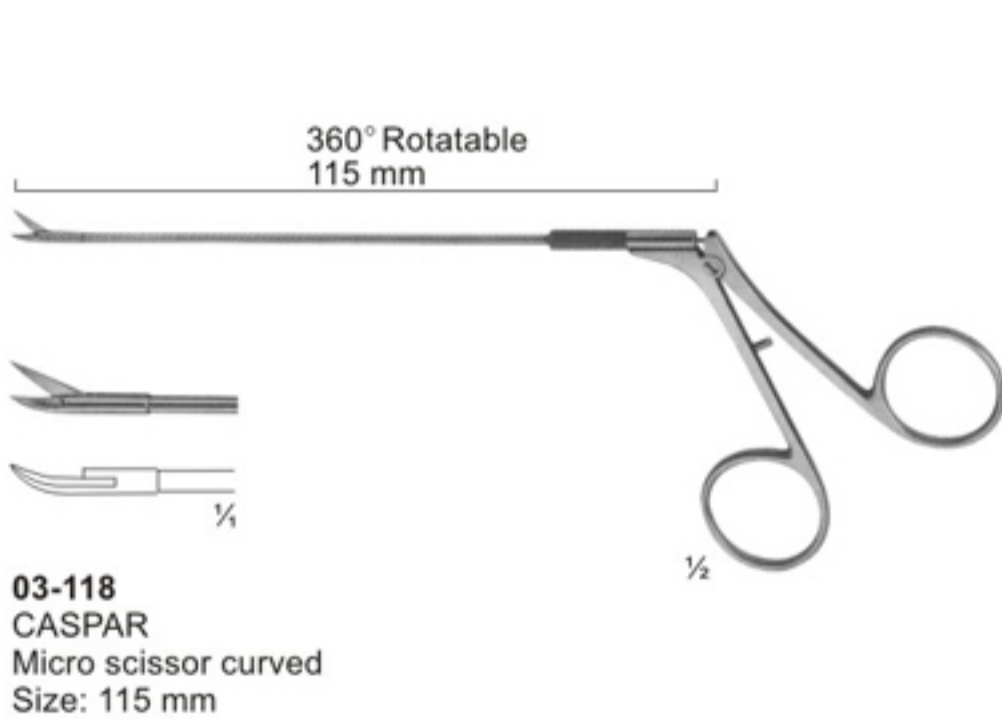
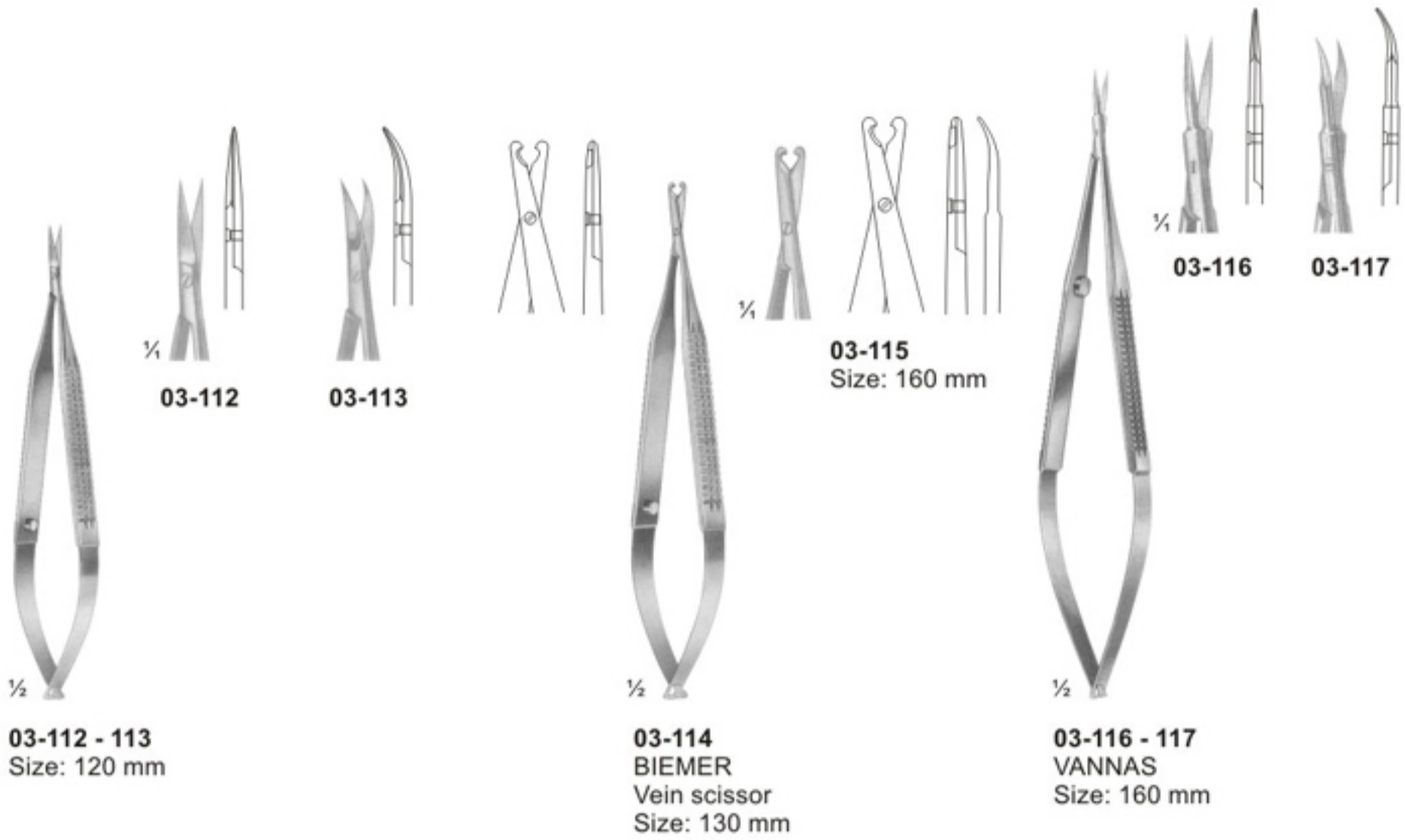

Micro Scissors (Spring Type) bayonet-Shaped



1/2
03-122
YASARGIL
Size: 245 mm



1/4
03-123
45°



1/4
03-124
45°



125°



1/2
03-123 - 124
laterally angled
Size: 200 mm



1/4
03-126

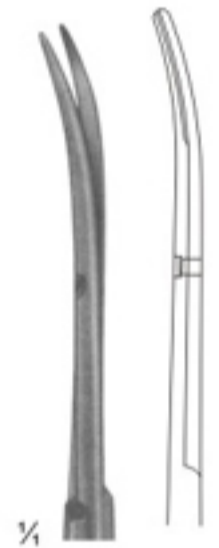

1/4
03-127



1/2
03-125
laterally angled
Size: 190 mm



1/2
03-126 - 127
YASARGIL
Size: 225 mm

Delicate Scissors

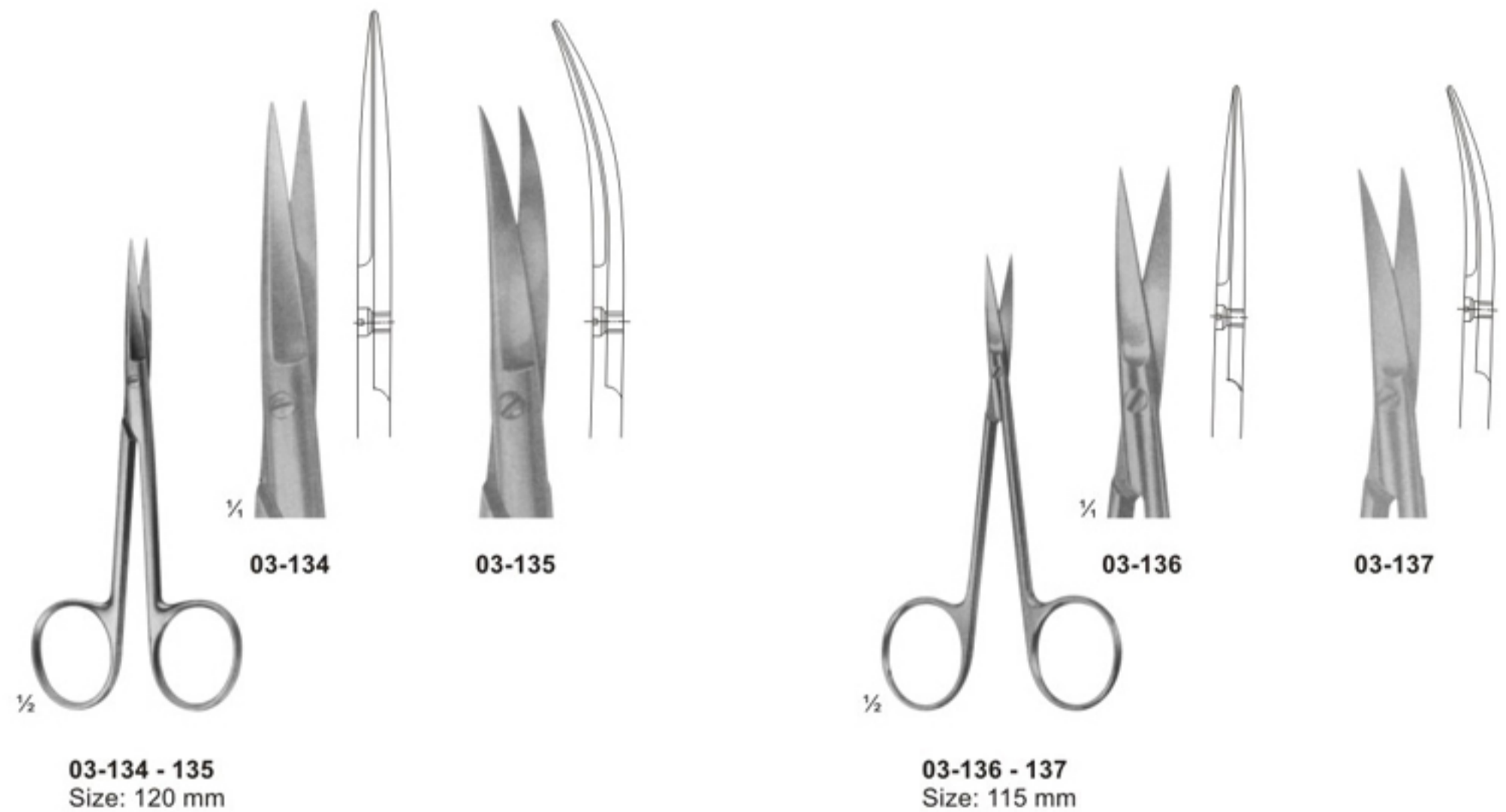
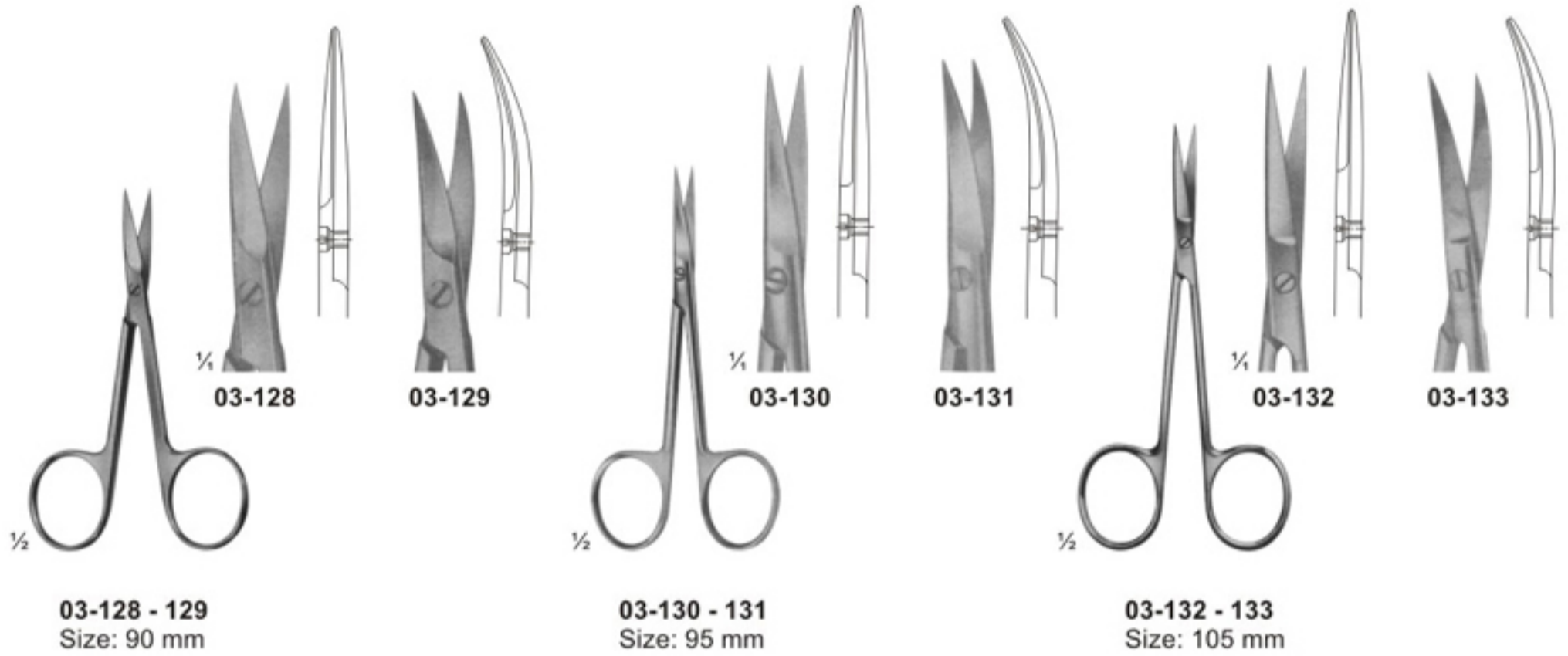

Delicate Scissors



03-138 - 140
Size: 120 mm

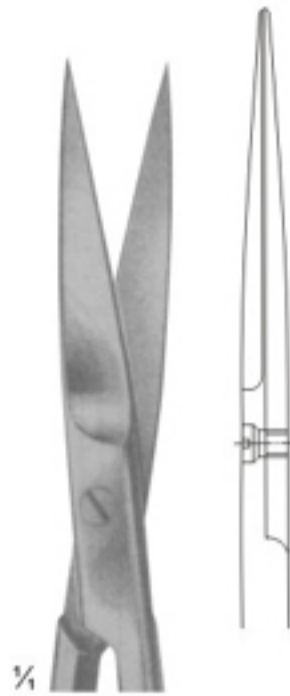

03-138

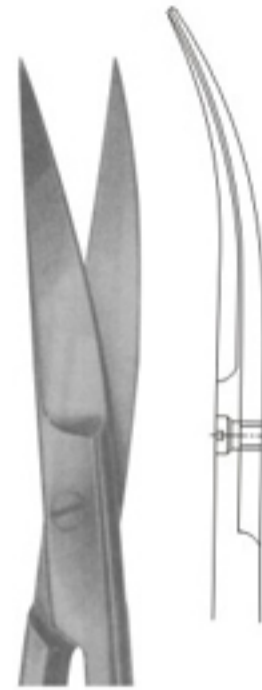

03-139

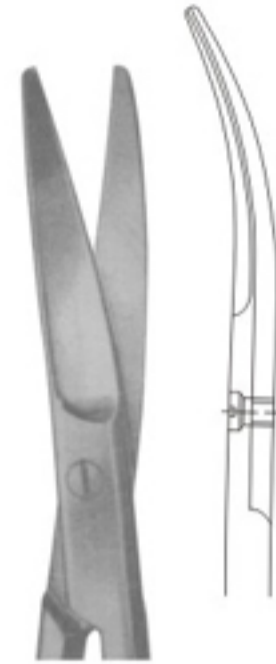

03-140



03-141 - 144
Size: 130 mm

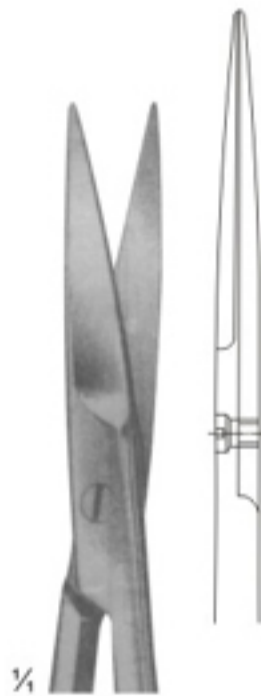

03-141



03-142

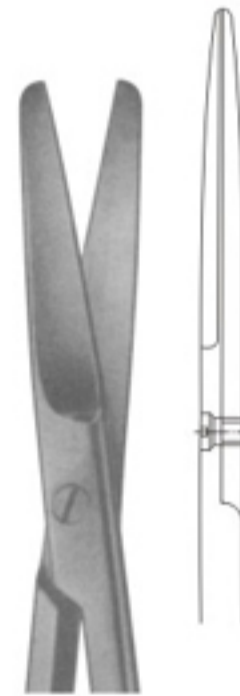

03-143

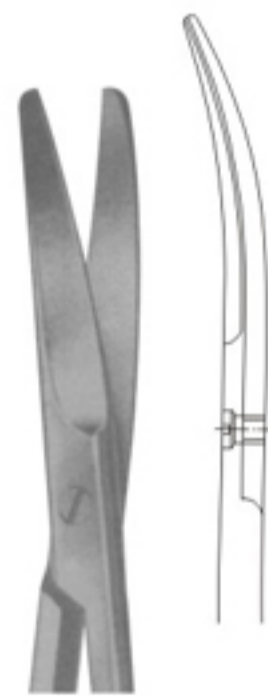

03-144

Surgical Scissors

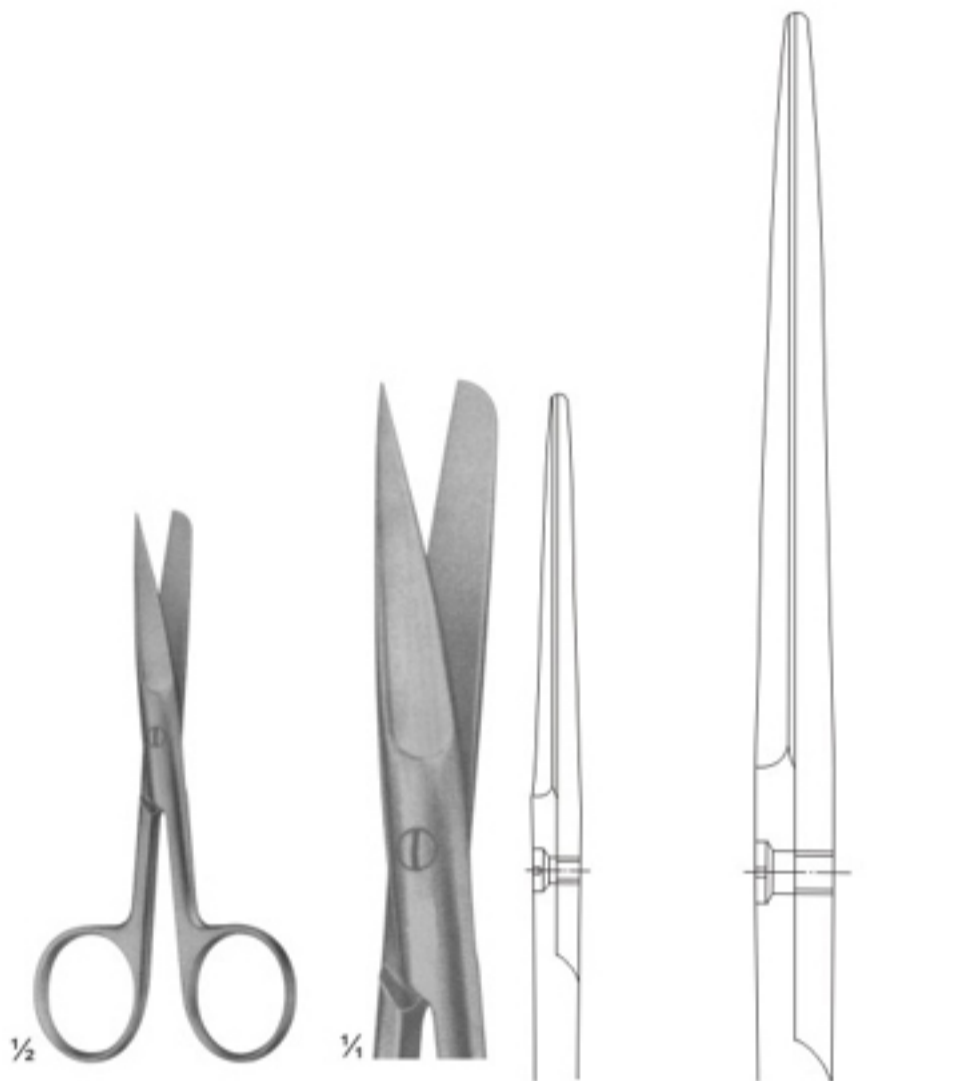

03-145 - 153 (Standard types)
 03-145 (105 mm)
 03-146 (115 mm)
 03-147 (130 mm)
 03-148 (145 mm)
 03-149 (150 mm)
 03-150 (165 mm)
 03-151 (175 mm)
 03-152 (185 mm)
 03-153 (200 mm)

03-145 **03-153**
 Size: 105 mm Size: 200 mm



03-154 - 160 (Standard types)
 03-154 (115 mm)
 03-155 (130 mm)
 03-156 (145 mm)
 03-157 (150 mm)
 03-158 (165 mm)
 03-159 (175 mm)
 03-160 (185 mm)

03-154 **03-160**
 Size: 115 mm Size: 185 mm

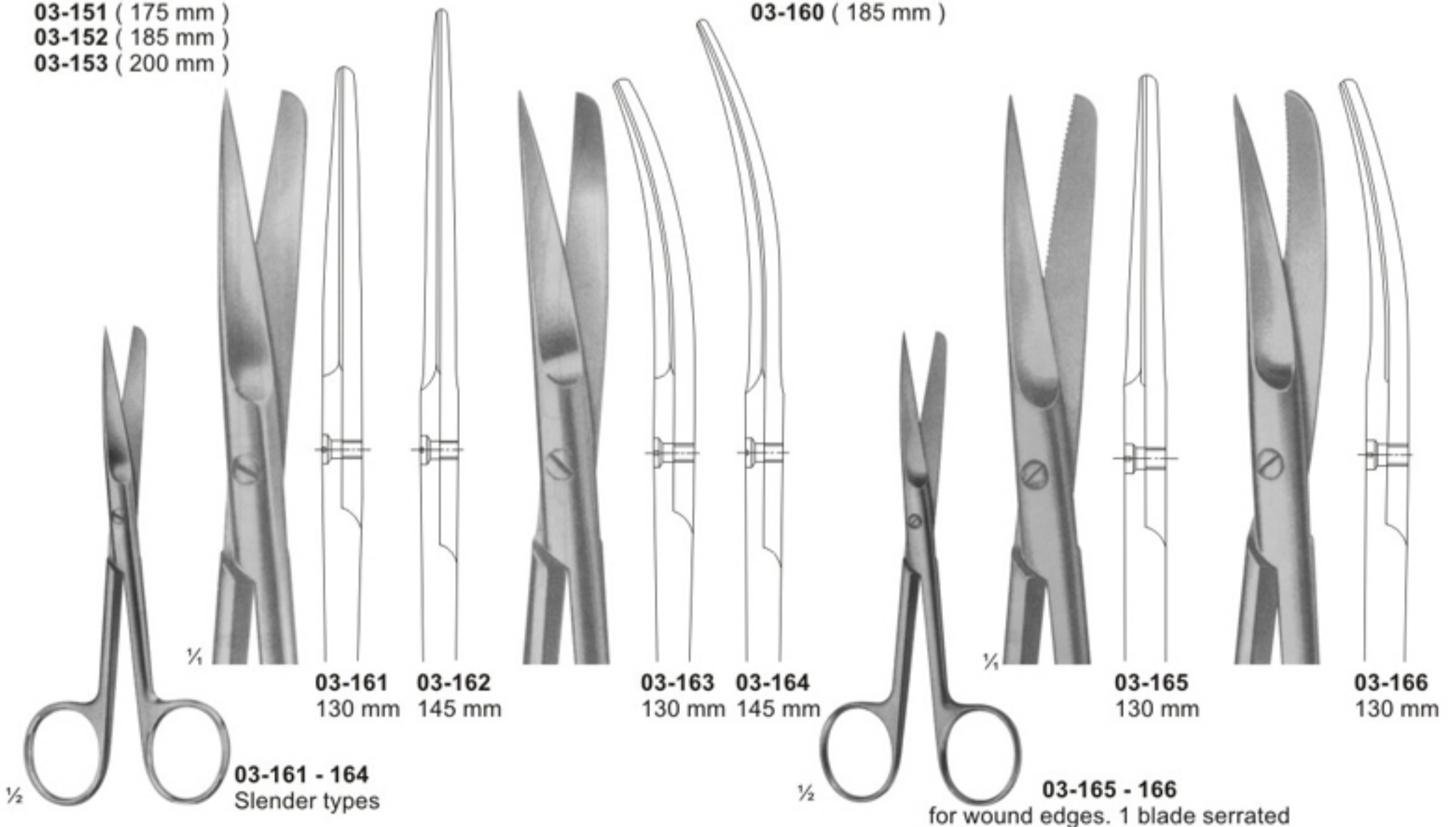

03-161 - 164
 Slender types

03-165 - 166
 for wound edges. 1 blade serrated

Surgical Scissors



03-167 - 169
DEAVER
with flat lock

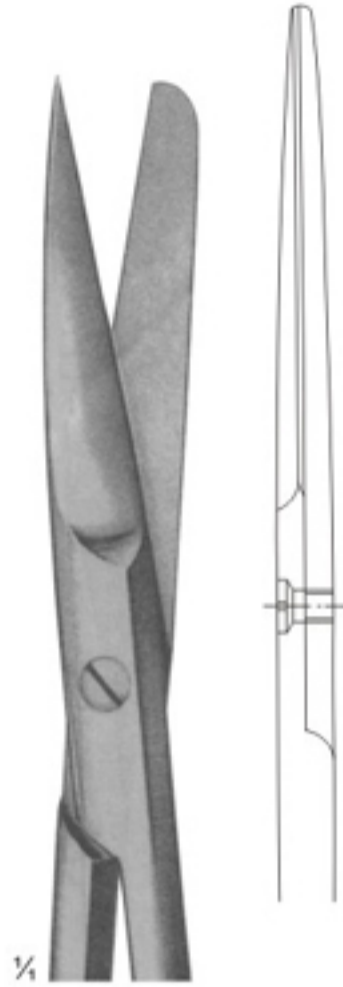

03-167
Size: 145 mm

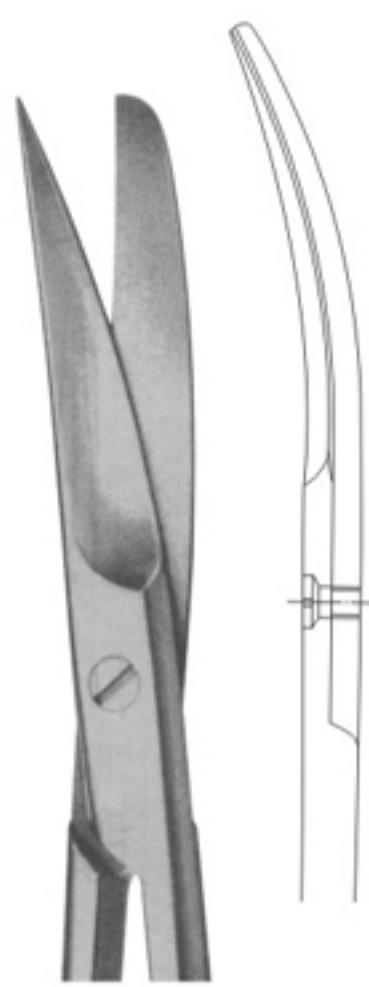

03-168
Size: 145 mm

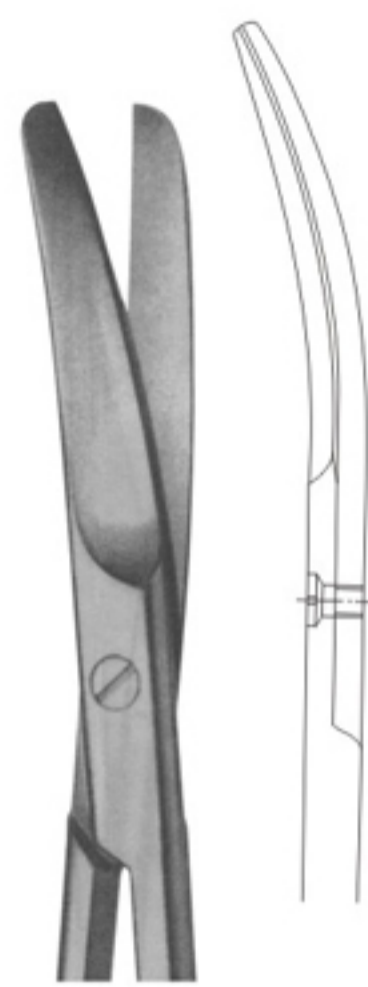

03-169
Size: 145 mm



03-170 - 172
Incision scissors



03-170
Size: 130 mm



03-171
Size: 145 mm

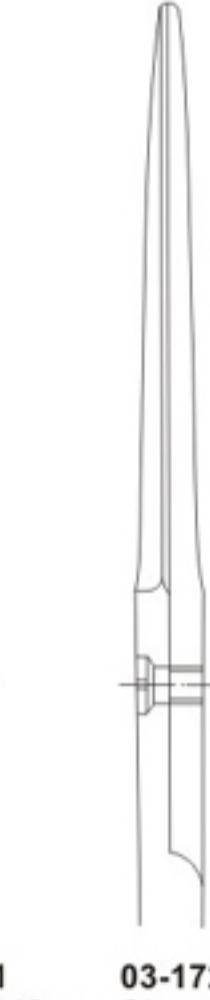

03-172
Size: 165 mm



03-173
SYSTRUNK
Nail splitting scissors

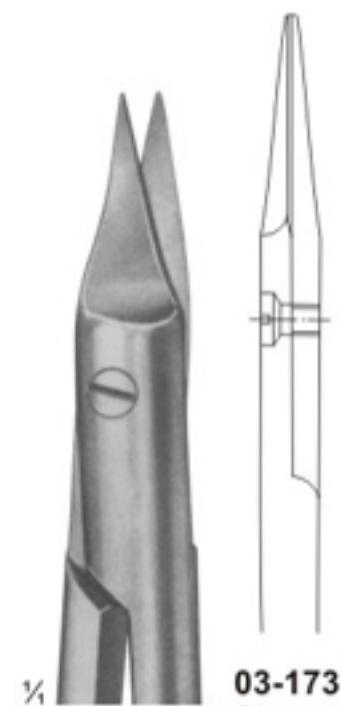

03-173
Size: 130 mm

Dissecting Scissors

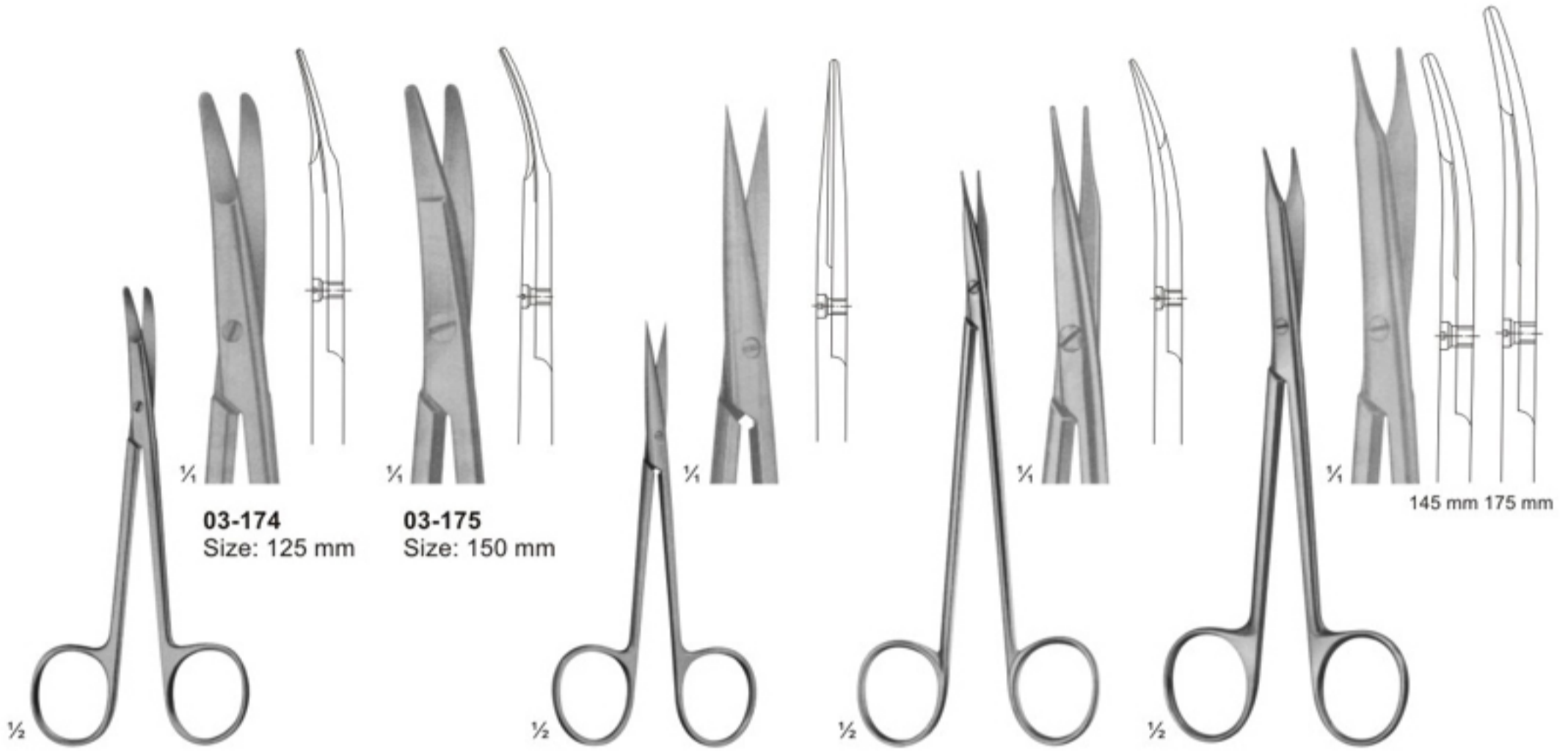

03-174 - 175
KILNER
Special flat points for dissecting and undermining the skin

03-176
KILNER
Fine dissecting scissors
Size: 115 mm

03-177
JAMESON
Dissecting scissors
Size: 150 mm

03-178
REYNOLDS
Dissecting scissors
Size: 145 - 175 mm

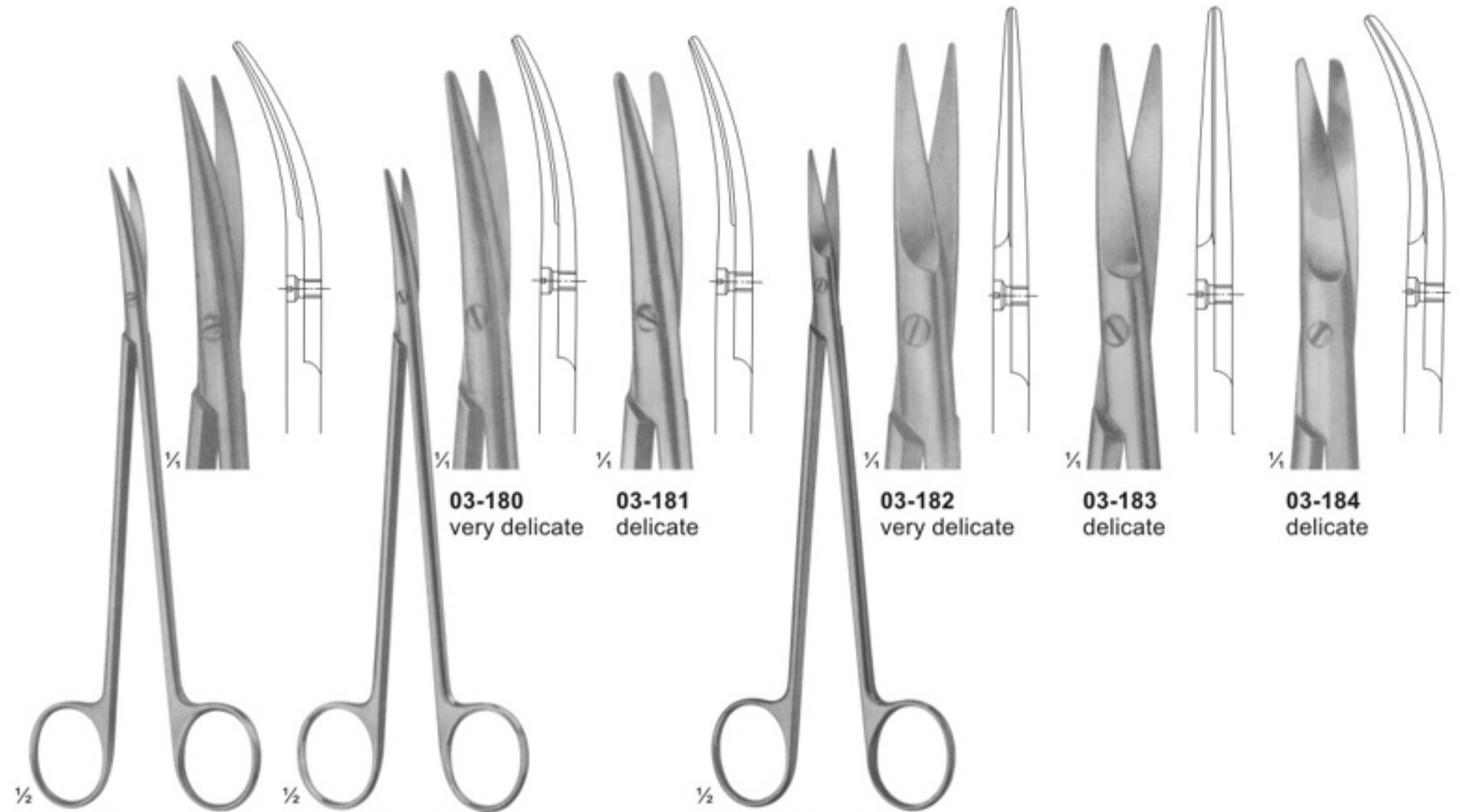

03-179
DE BAKEY
Arteriotomy scissors
Size: 175 mm

03-180 - 181
TOENNIS ADSON
Dissecting scissors
Size: 175 mm

03-182 - 184
TOENNIS
Dissecting scissors
Size: 180 mm

Dissecting Scissors

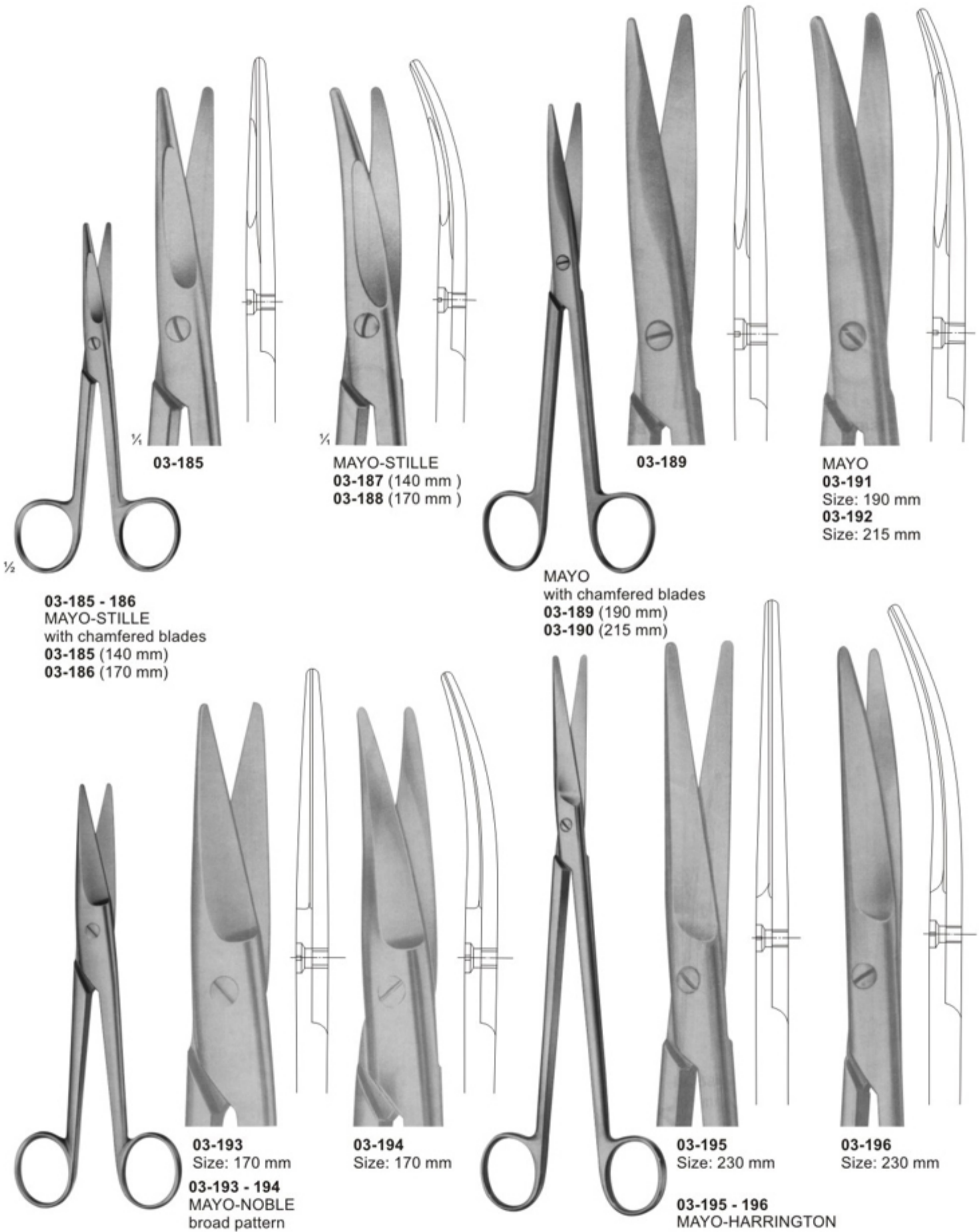

Scissors for Cardiovascular and Neuro-Surgery



03-197
OLIVECRONA
Dura scissors

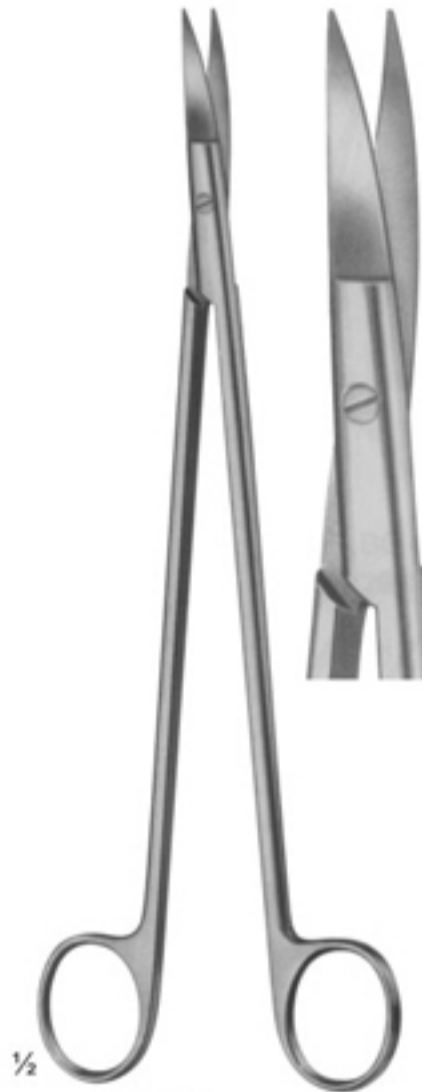

03-198
STRULLY
pointed
Size: 220 mm

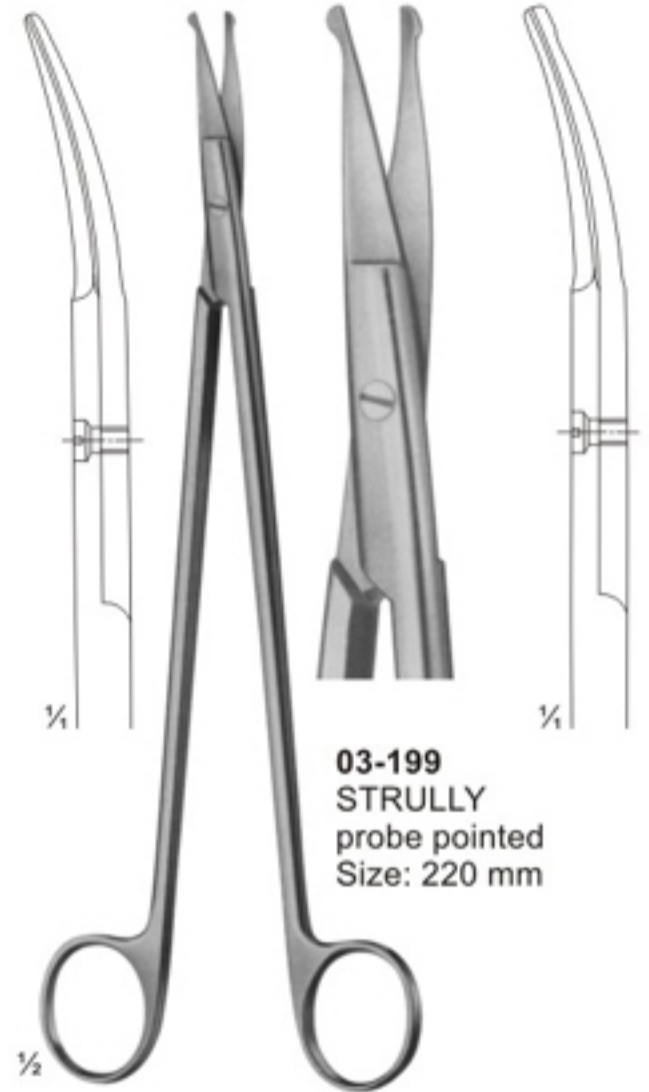

03-199
STRULLY
probe pointed
Size: 220 mm

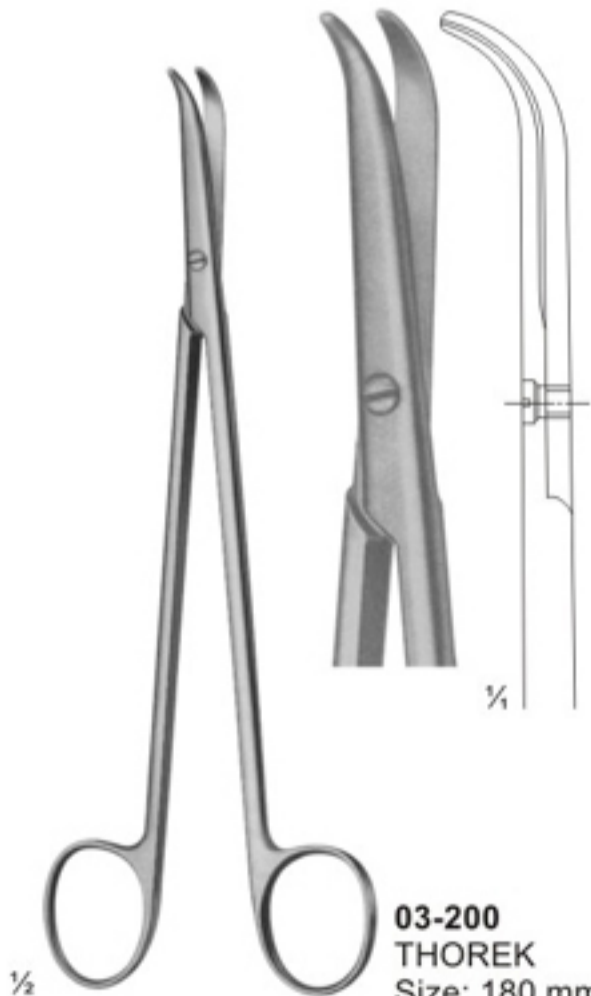

03-200
THOREK
Size: 180 mm

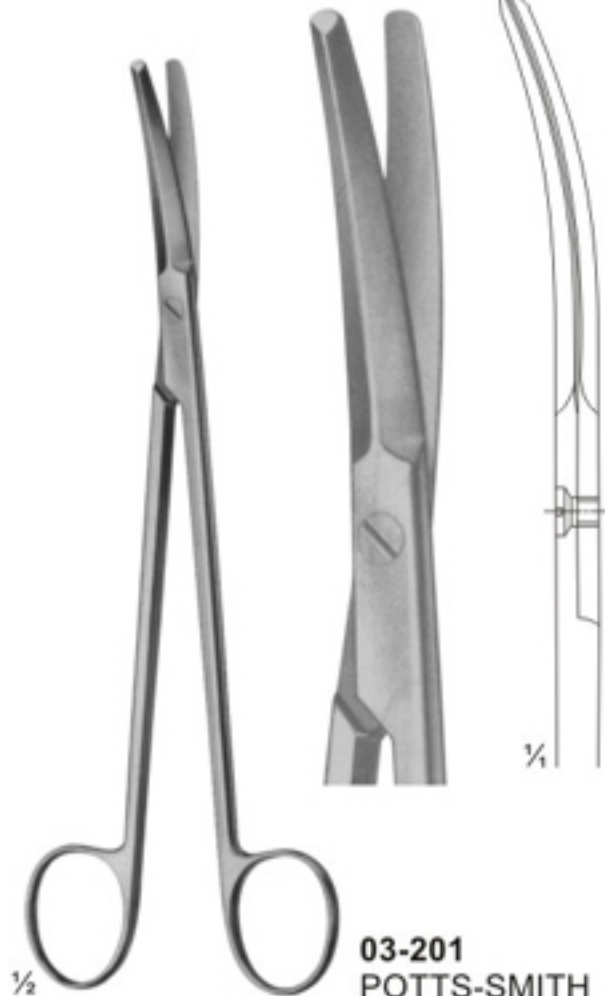

03-201
POTTS-SMITH
Size: 190 mm

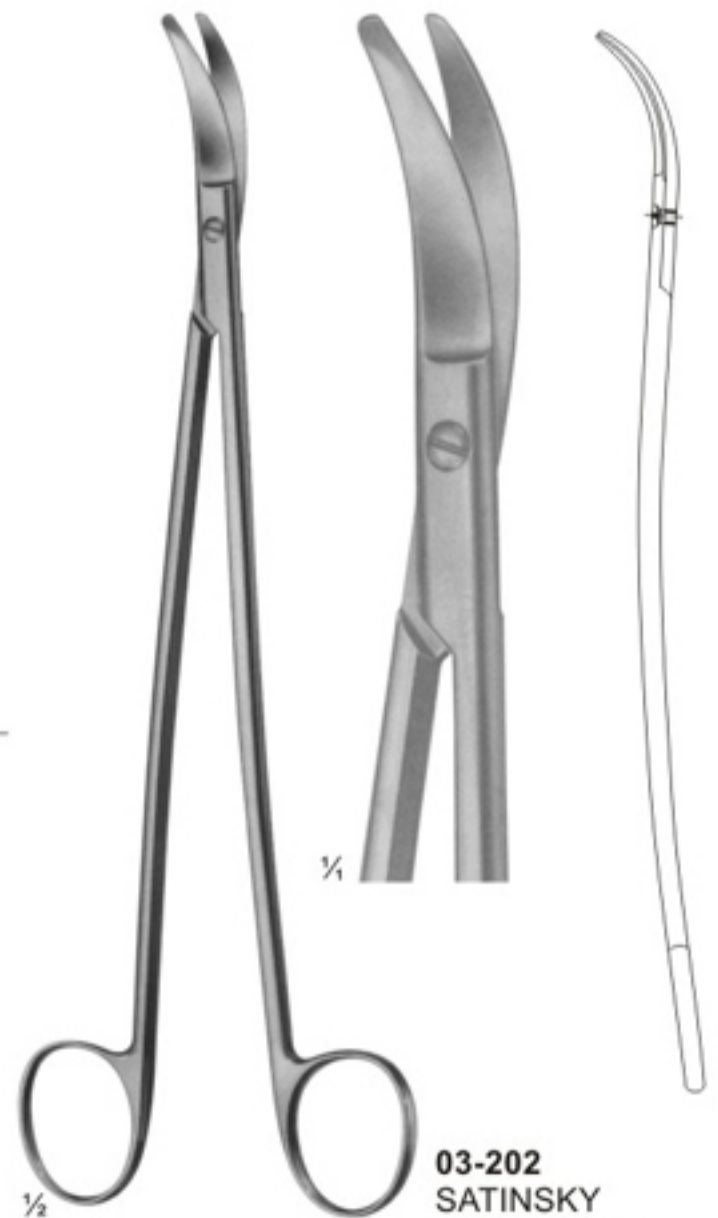

03-202
SATINSKY
Size: 245 mm

Delicate, Nasal and Tonsil Scissors



03-203
1 finely toothed blade
Size: 130 mm

03-204
LOCKLIN
curved sideways,
1 toothed blade
Size: 155 mm

03-205
FOMON
blades serrated
Size: 145 mm

03-206
COTTLE
Size: 165 mm

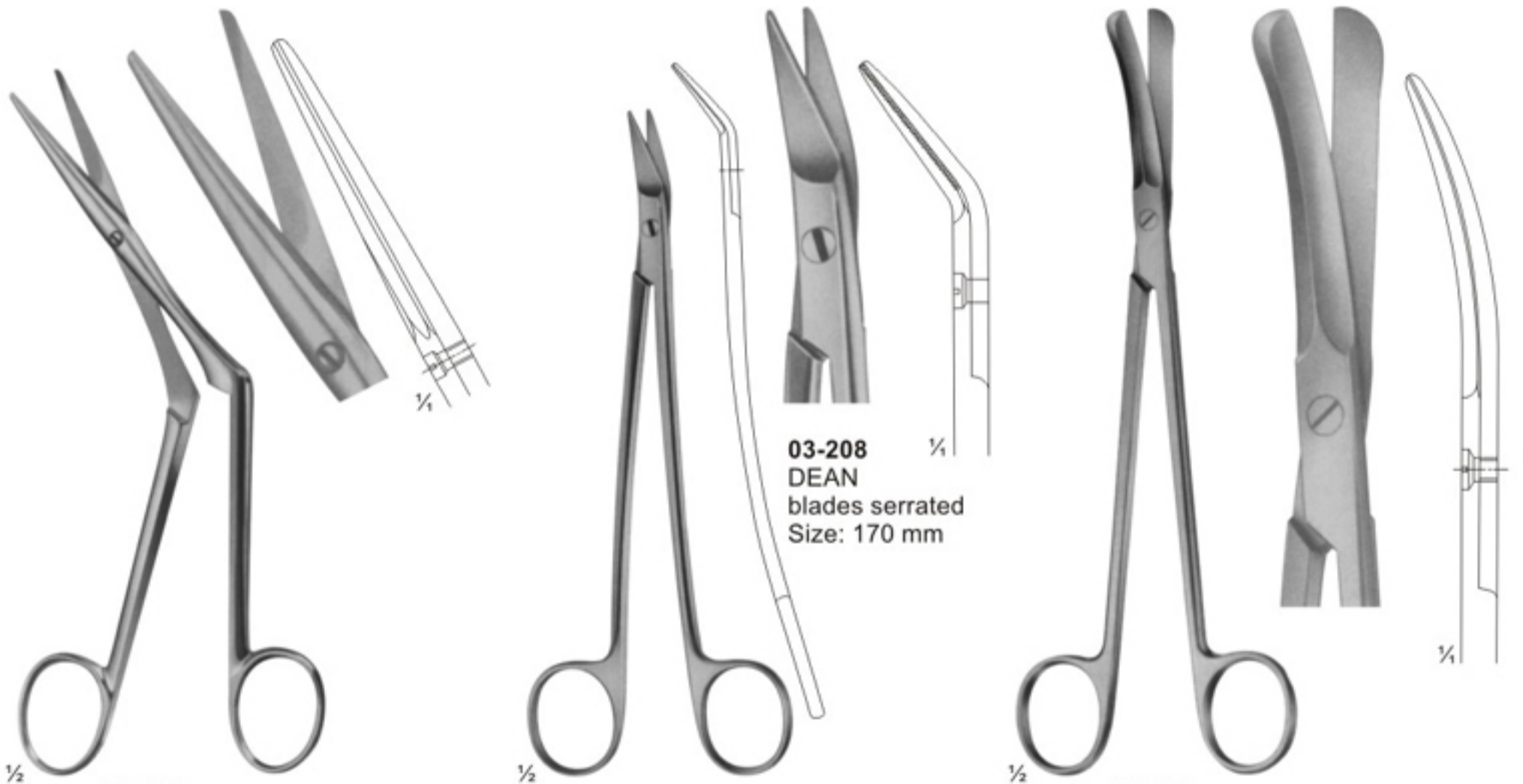

03-207
HEYMANN-KNIGHT
Size: 175 mm

03-208
DEAN
blades serrated
Size: 170 mm

03-209
GOOD
Size: 195 mm

Bone Shears

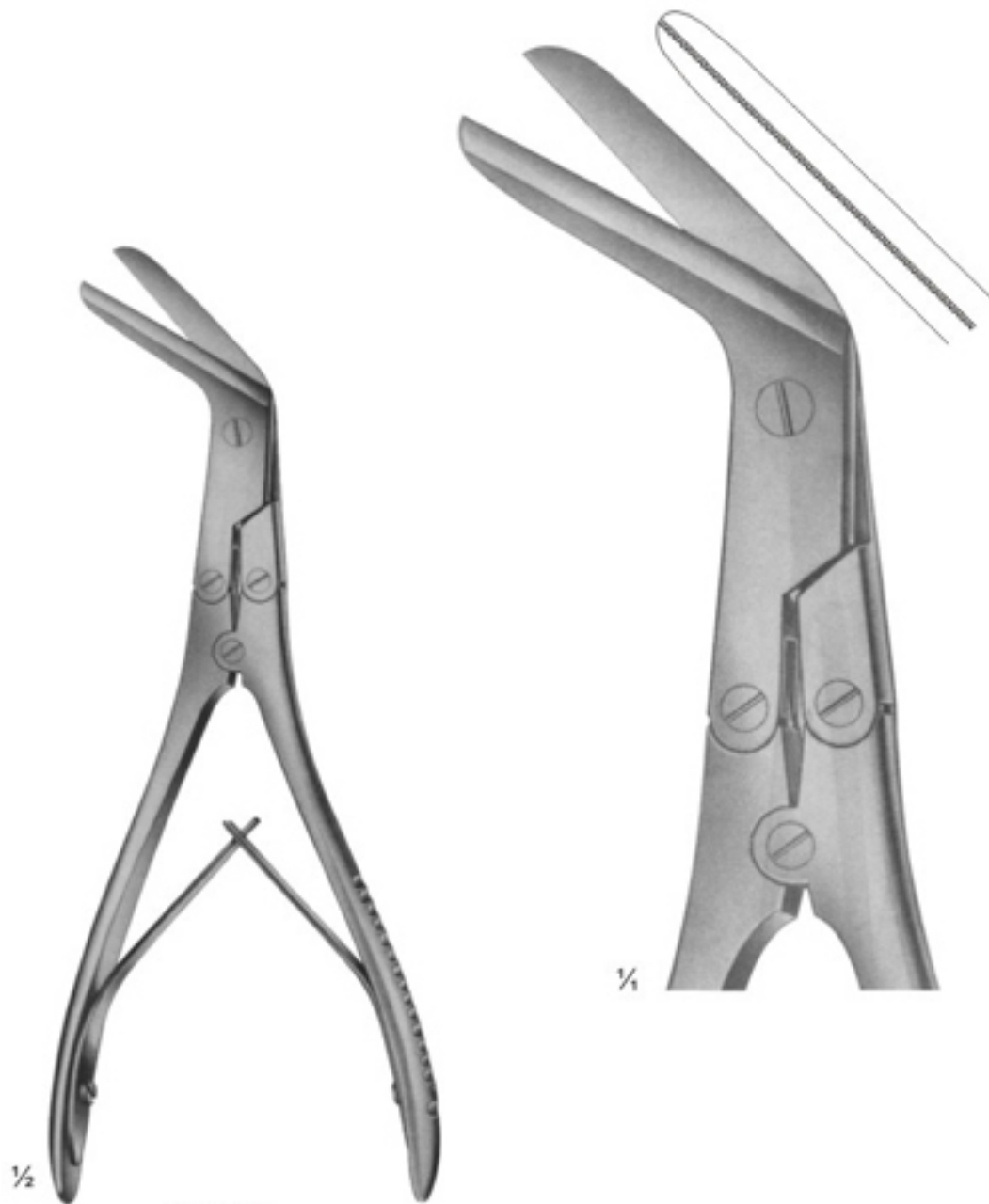

03-210
KILLIAN
Size: 200 mm



03-211 - 03-212

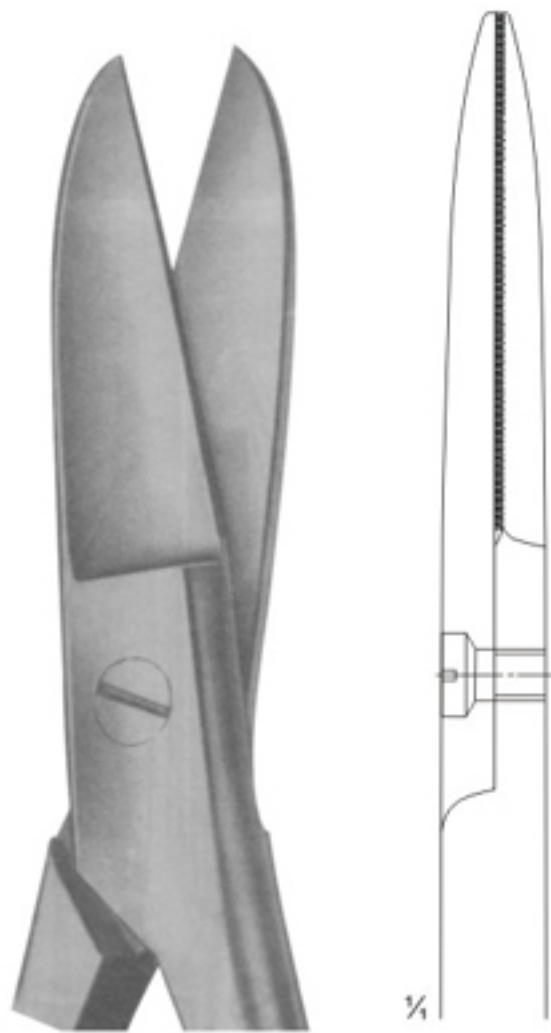

03-211
195 mm

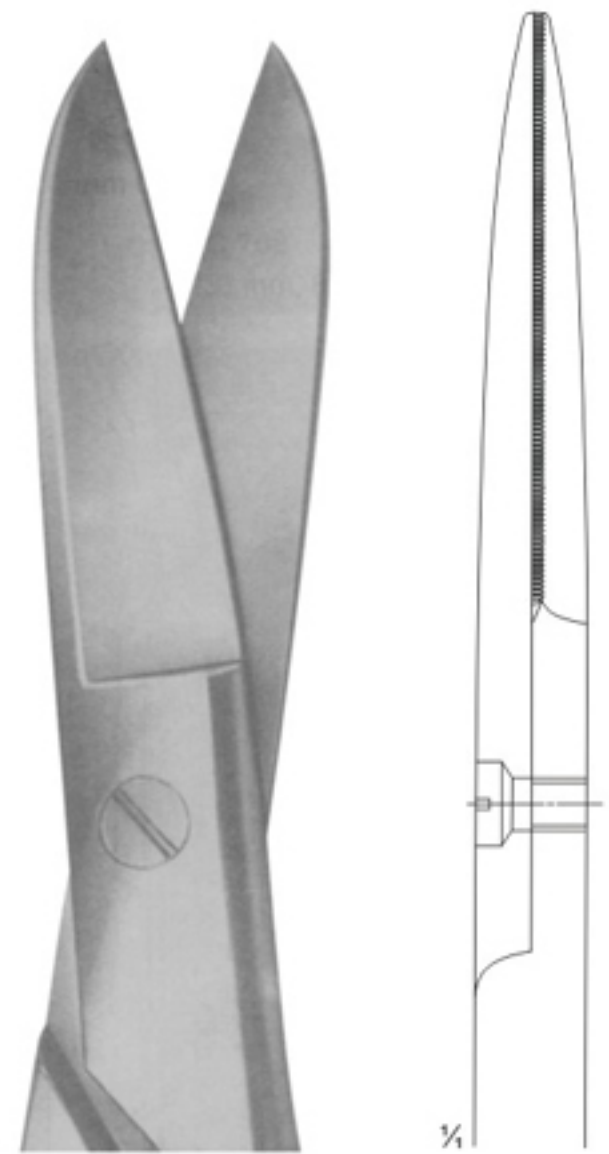

03-212
225 mm

Scissors for deep operations and for Gynaecology

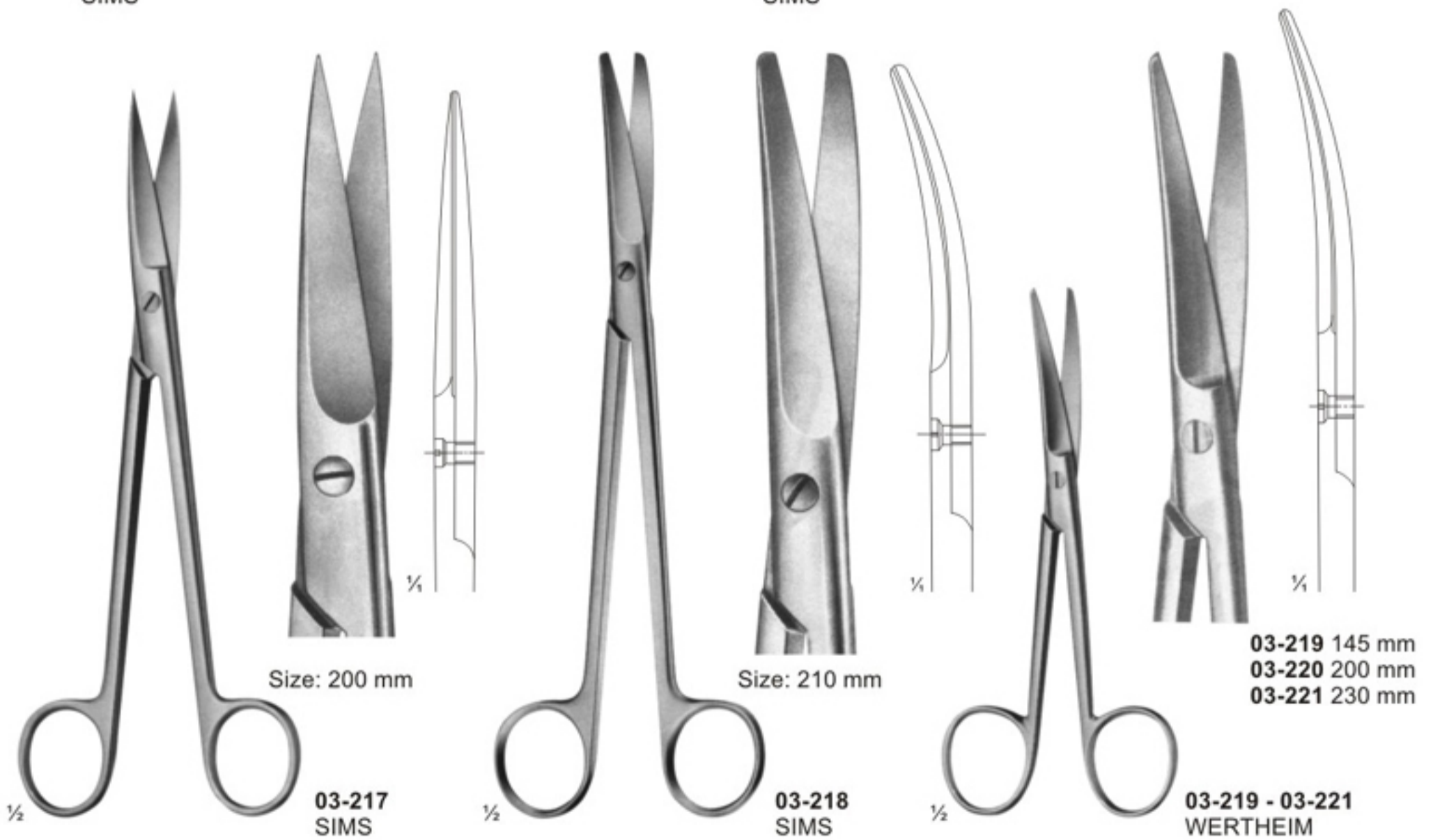
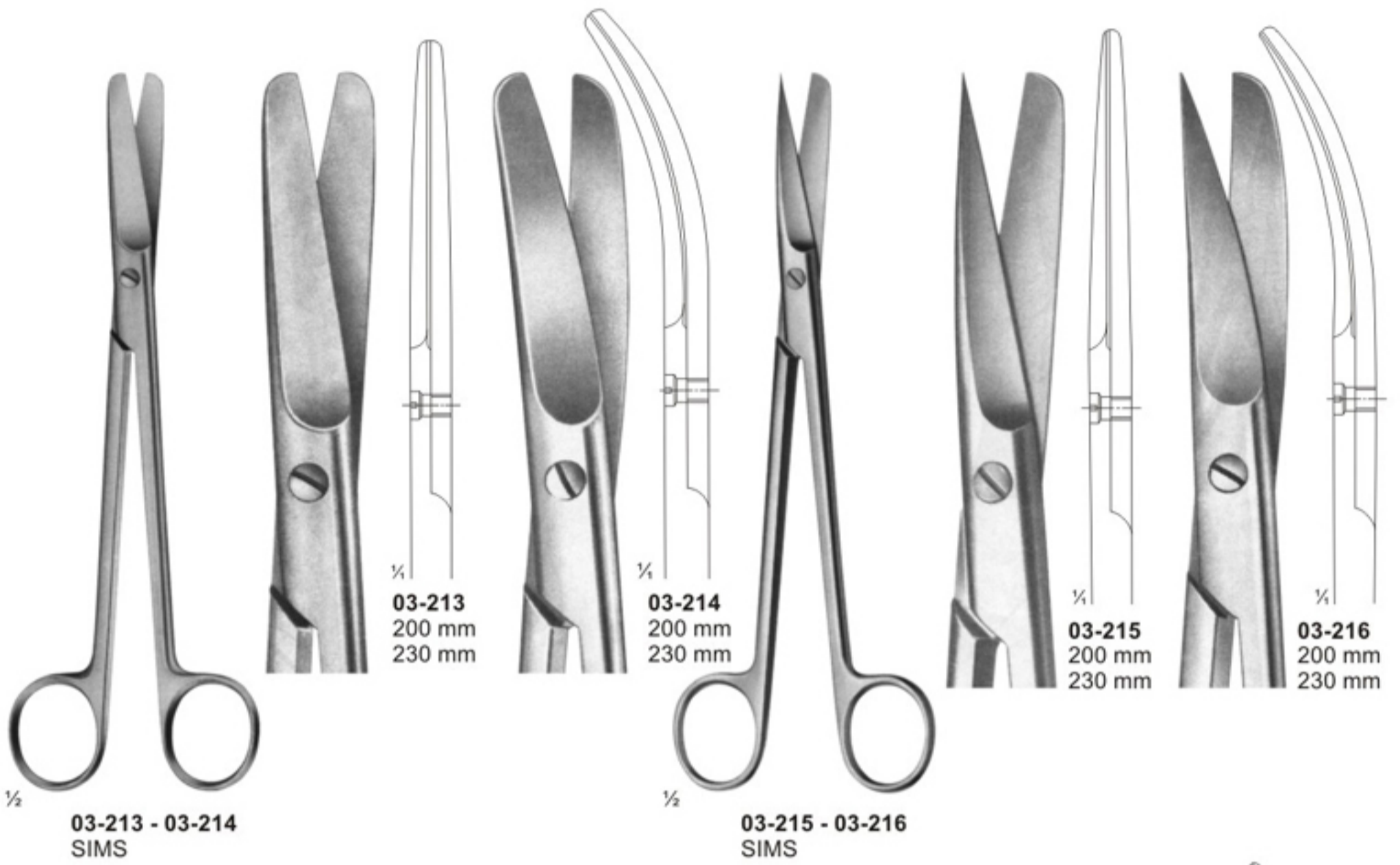

Scissors for Obstetrics



03-222
SCHUMACHER
Umbilical cord scissors
Size: 155 mm

03-223
Umbilical cord scissors
Size: 105 mm

03-224
Umbilical cord scissors
135 mm

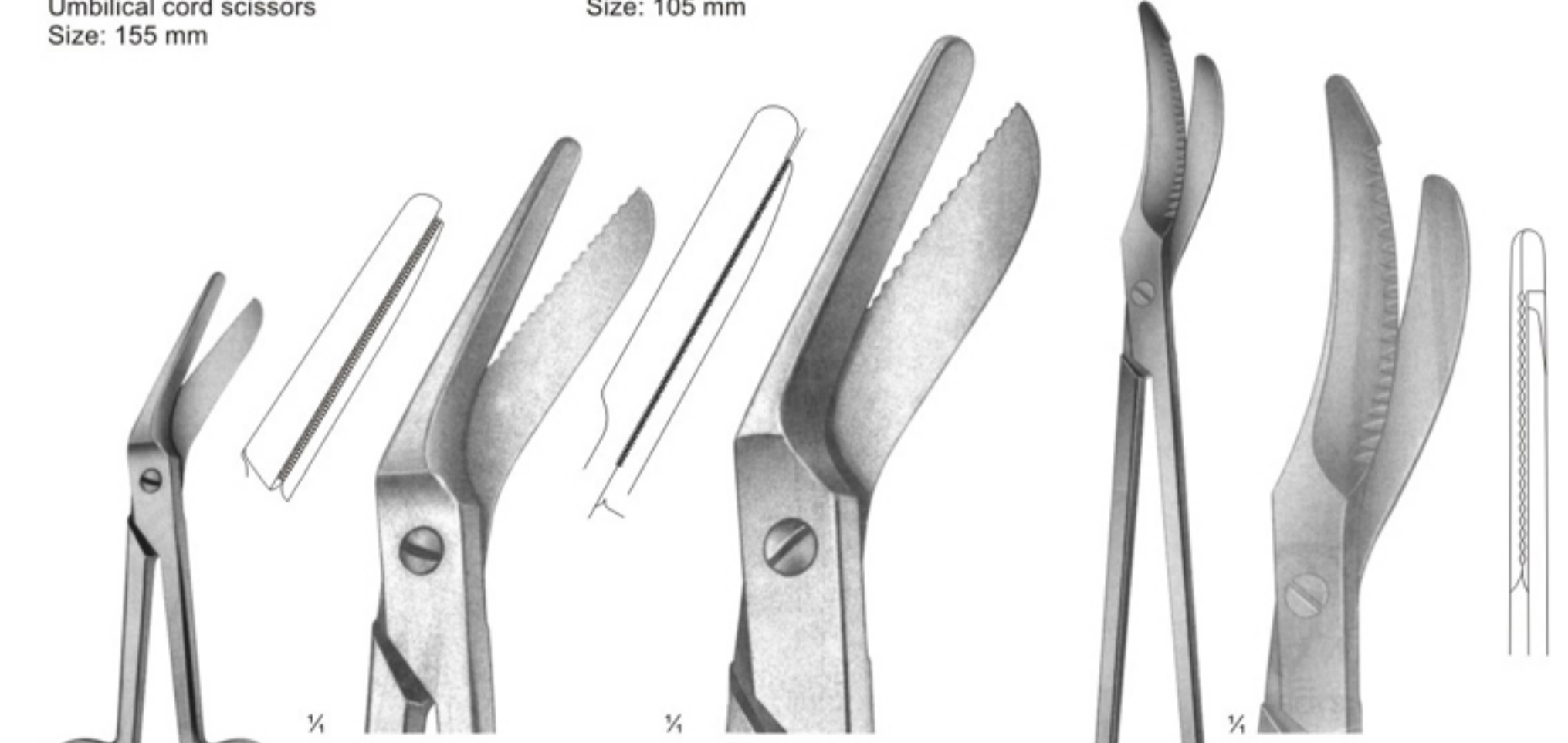

03-225 - 03-226
BRAUN-STADLER
Episiotomy scissors

03-225
145 mm

03-226
200 mm

03-227
Episiotomy scissors
240 mm

Wire and Plate Scissors

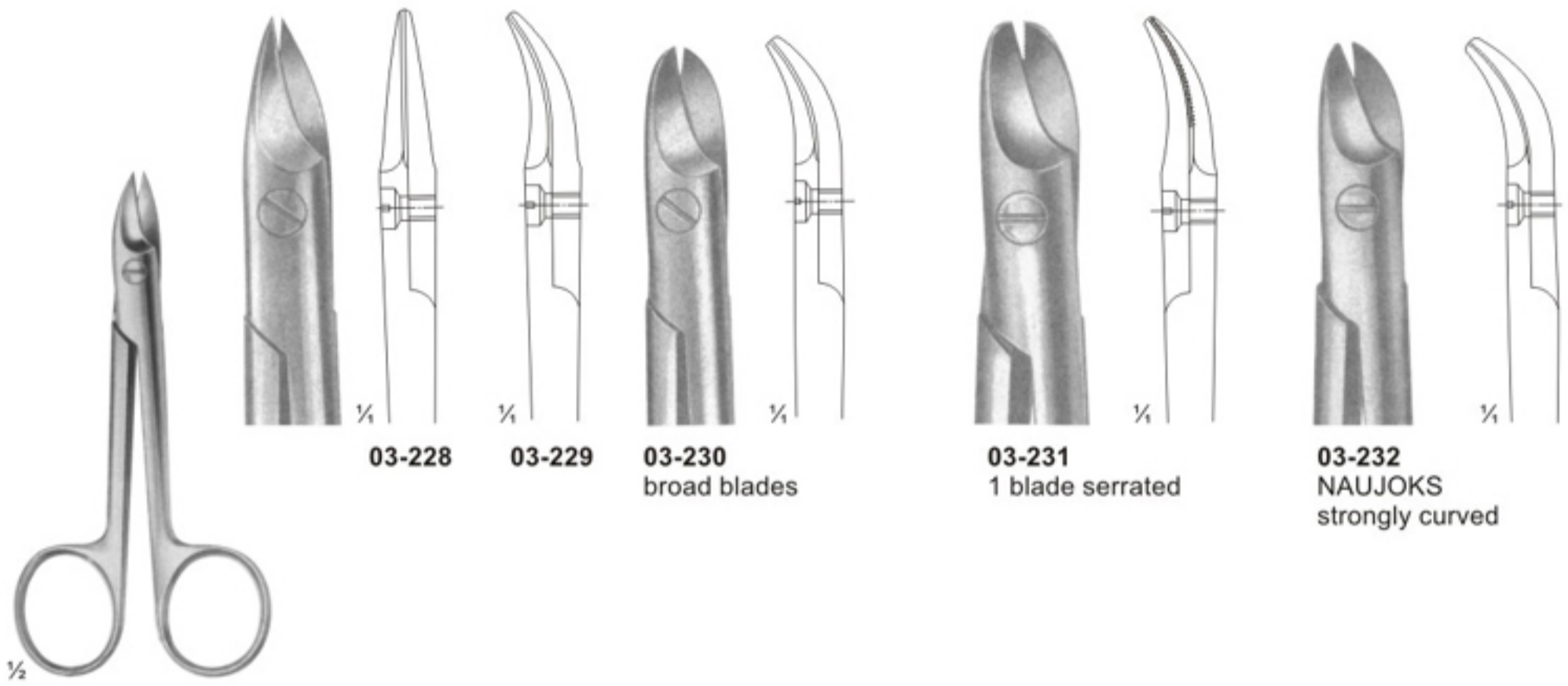

03-228

03-229

03-230
broad blades

03-231
1 blade serrated

03-232
NAUJOKS
strongly curved

03-228 - 03-232
BEEBE
Size: 110 mm

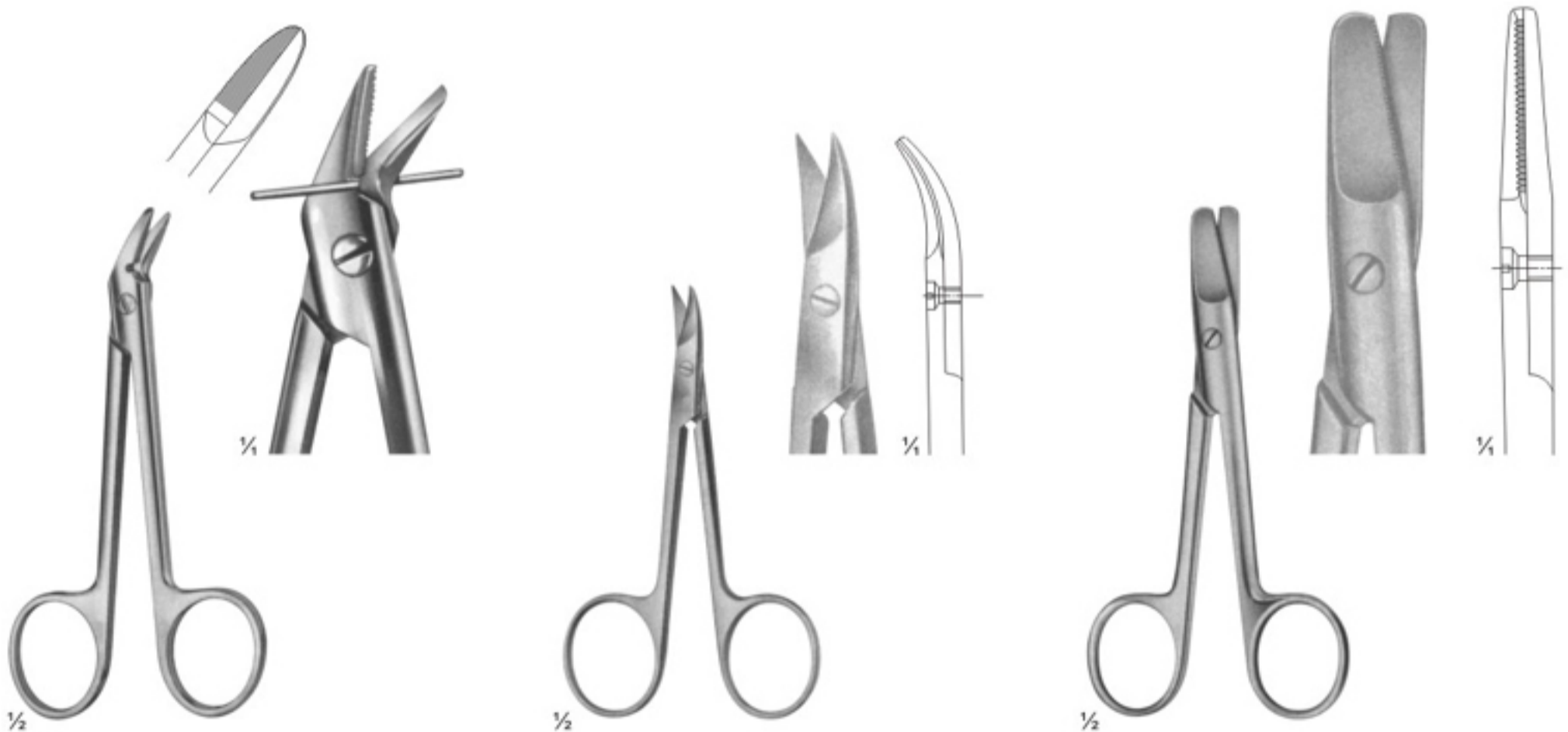

03-233
1 blade serrated
Size: 120 mm

03-234
STRACK
Size: 100 mm

03-235
HARVEY
blades serrated
Size: 125 mm

Bandage and Cloth Scissors



03-236
Universal bandage and cloth scissors,
with toothed edges
180 mm



03-237
LISTER
Universal bandage and cloth scissors,
with toothed edges
Size: 145 mm

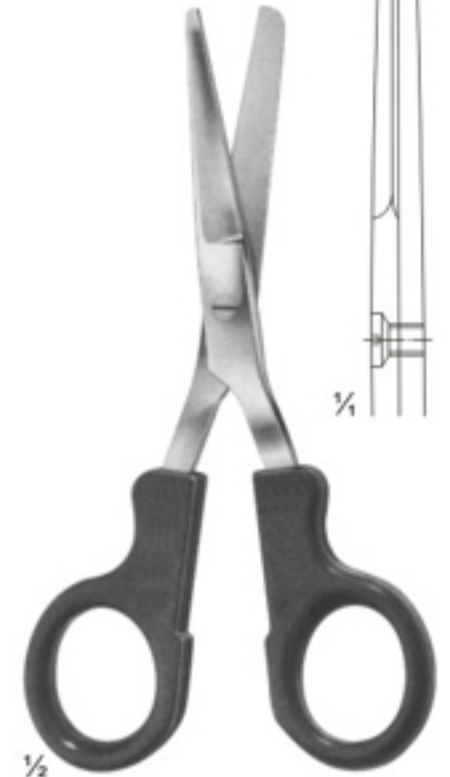

03-238
LISTER
Nurse's scissors
Size: 145 mm

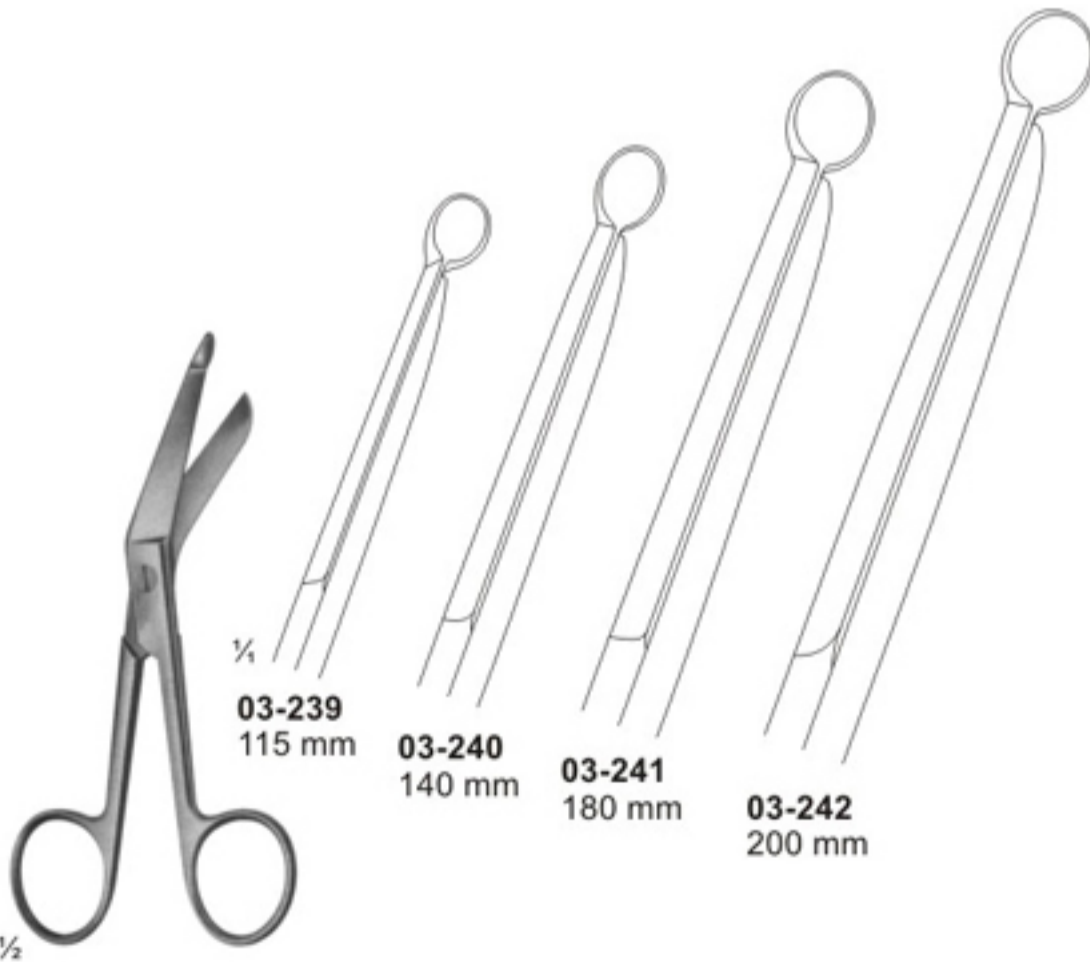

03-239 - 03-242
LISTER

03-239
115 mm

03-240
140 mm

03-241
180 mm

03-242
200 mm

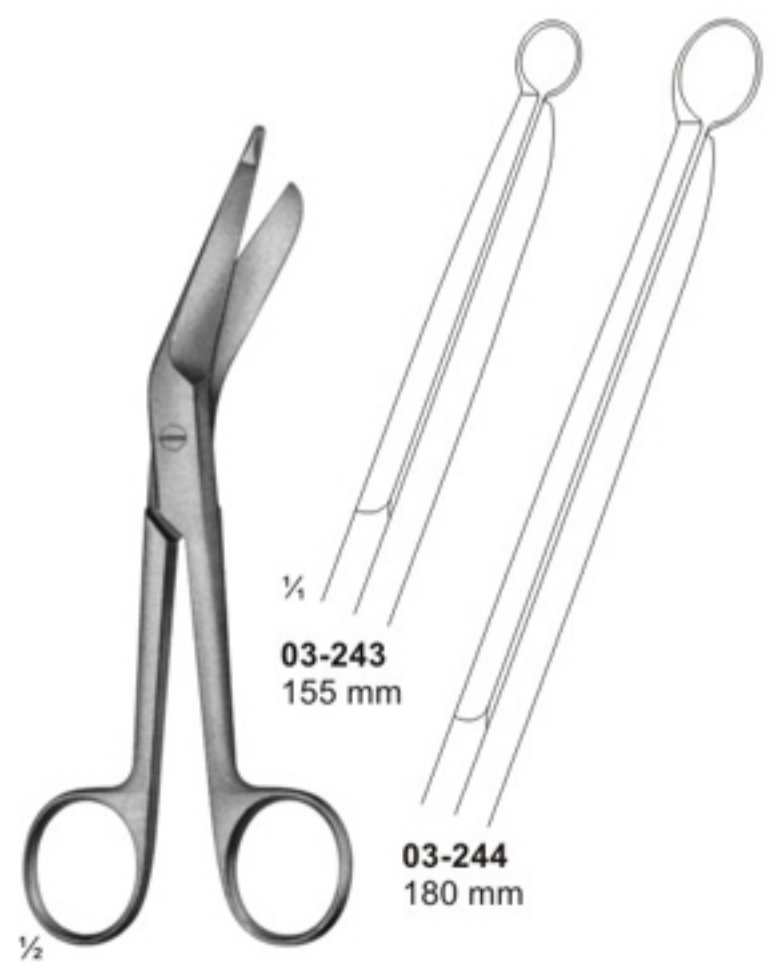

03-243 - 03-244
LISTER

03-243
155 mm

03-244
180 mm

Bandage-, Cloth-, and Plaster Scissors



03-245
CLOTH SCISSORS
205 mm

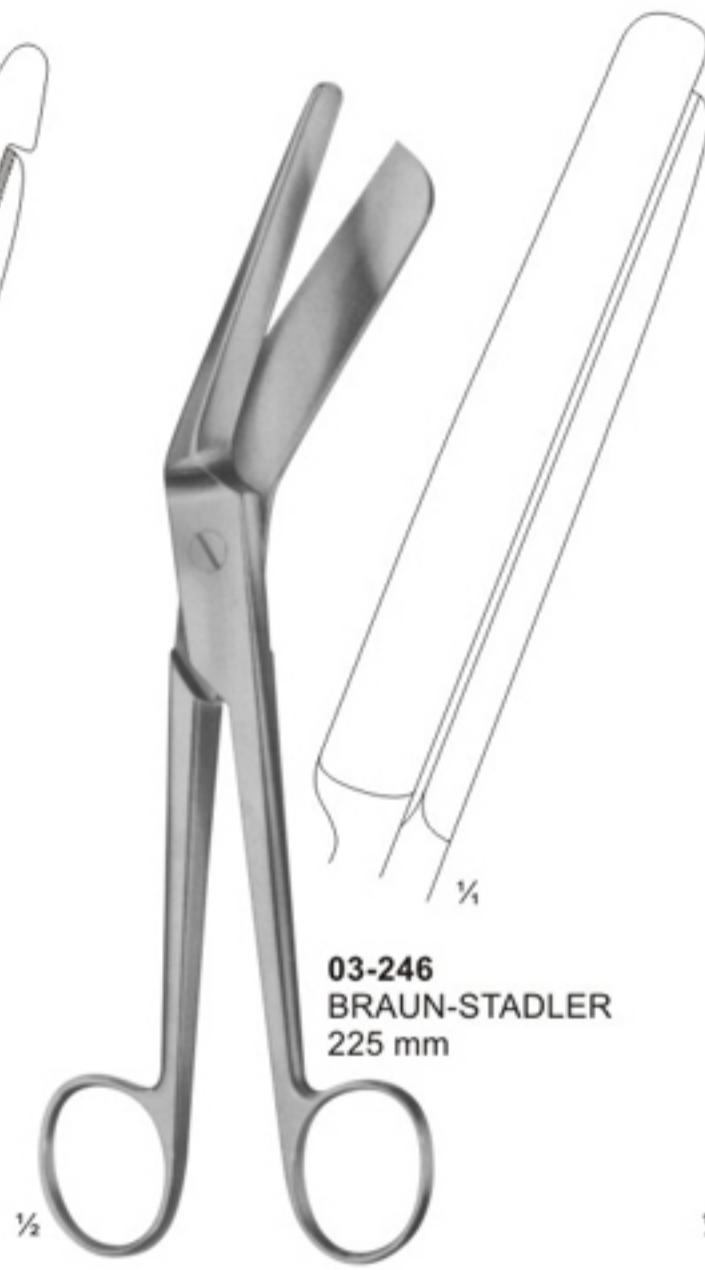

03-246
BRAUN-STADLER
225 mm

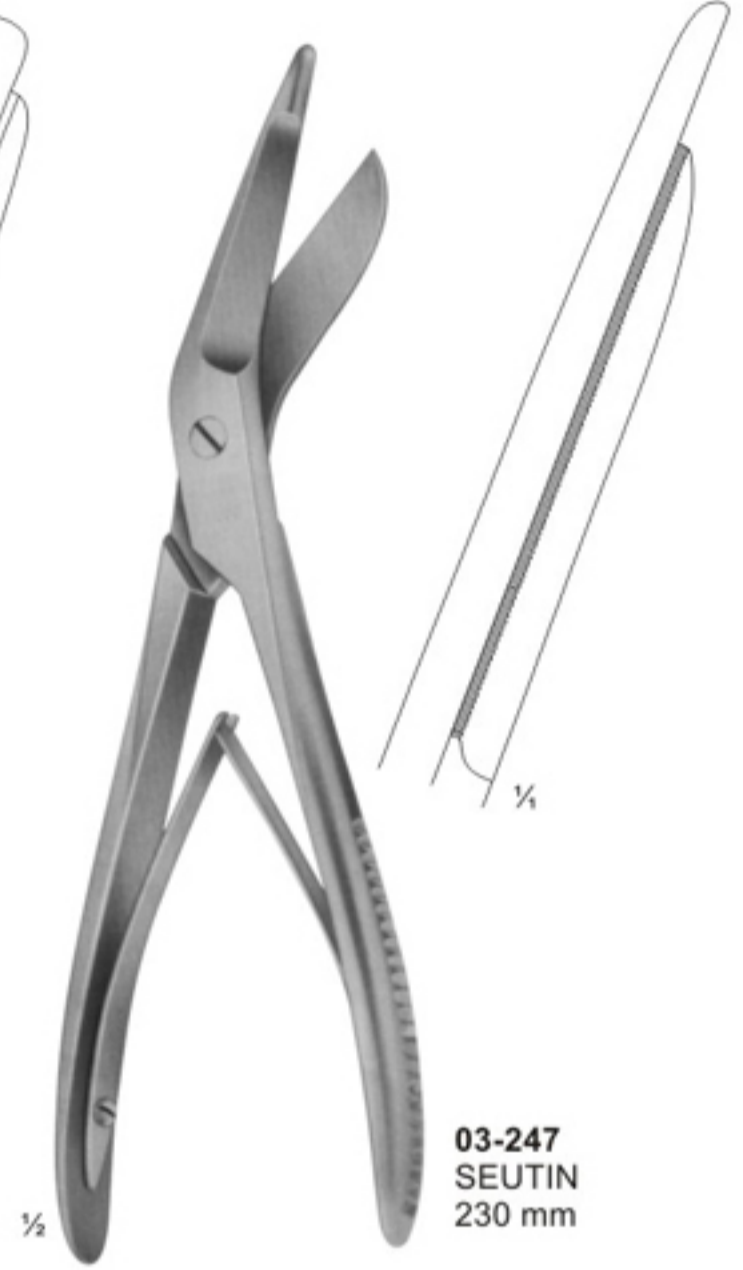

03-247
SEUTIN
230 mm

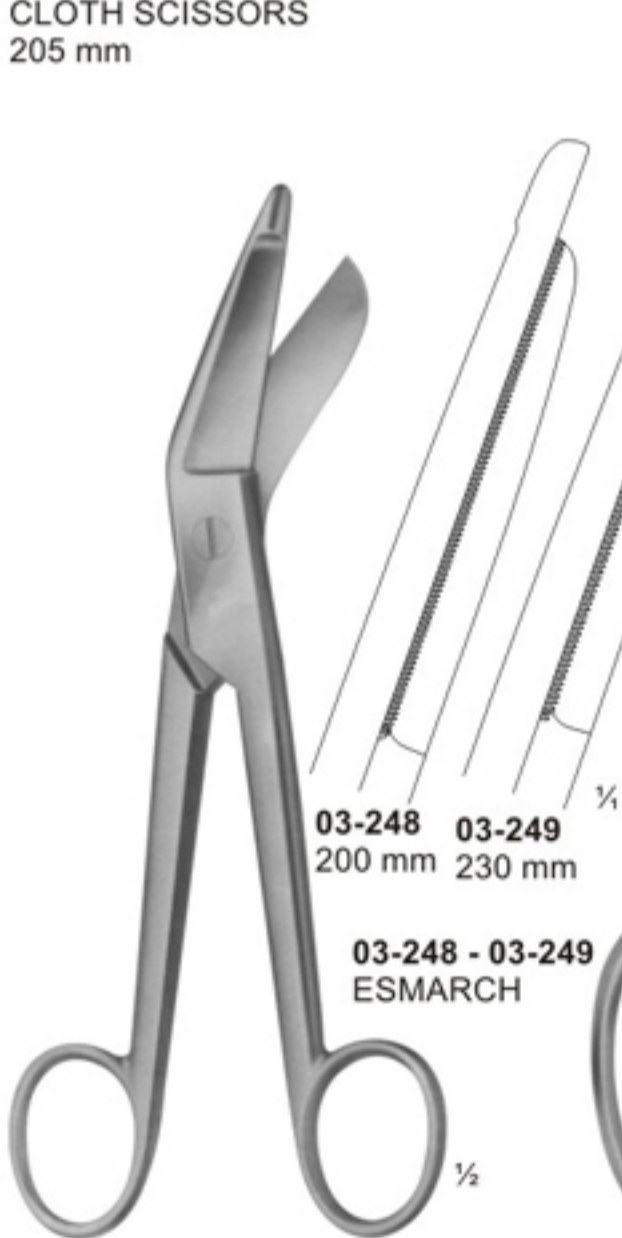

03-248 200 mm
03-249 230 mm

03-248 - 03-249
ESMARCH

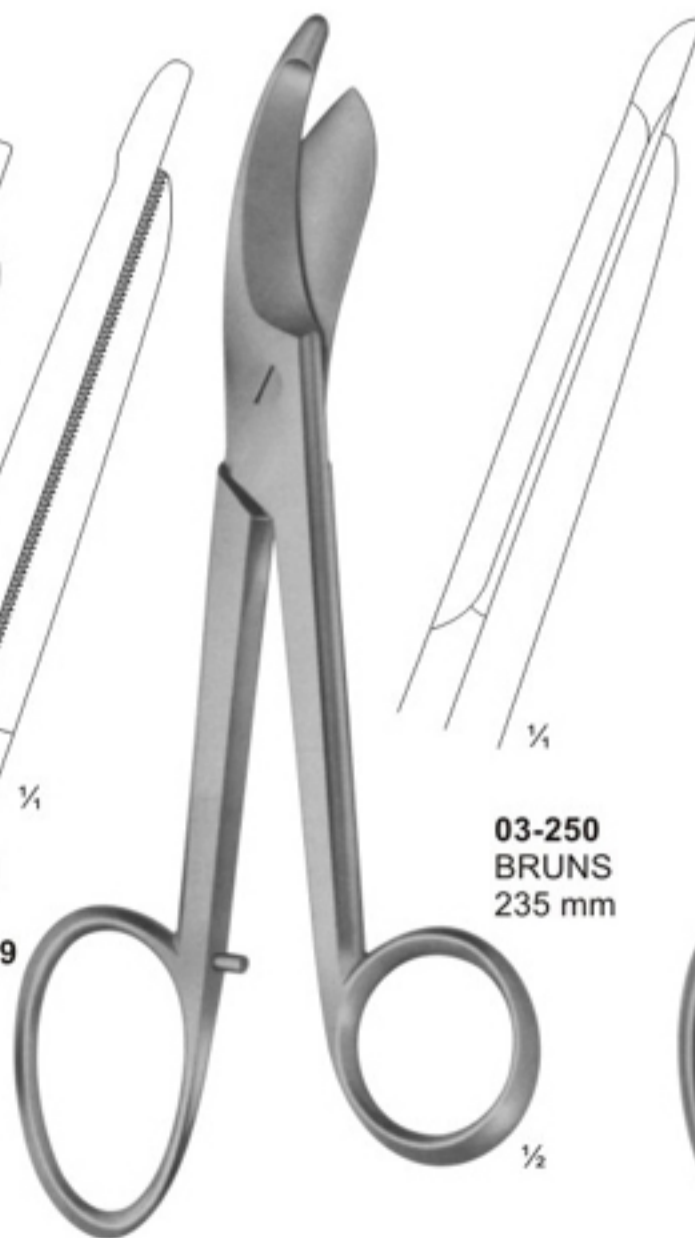

03-250
BRUNS
235 mm

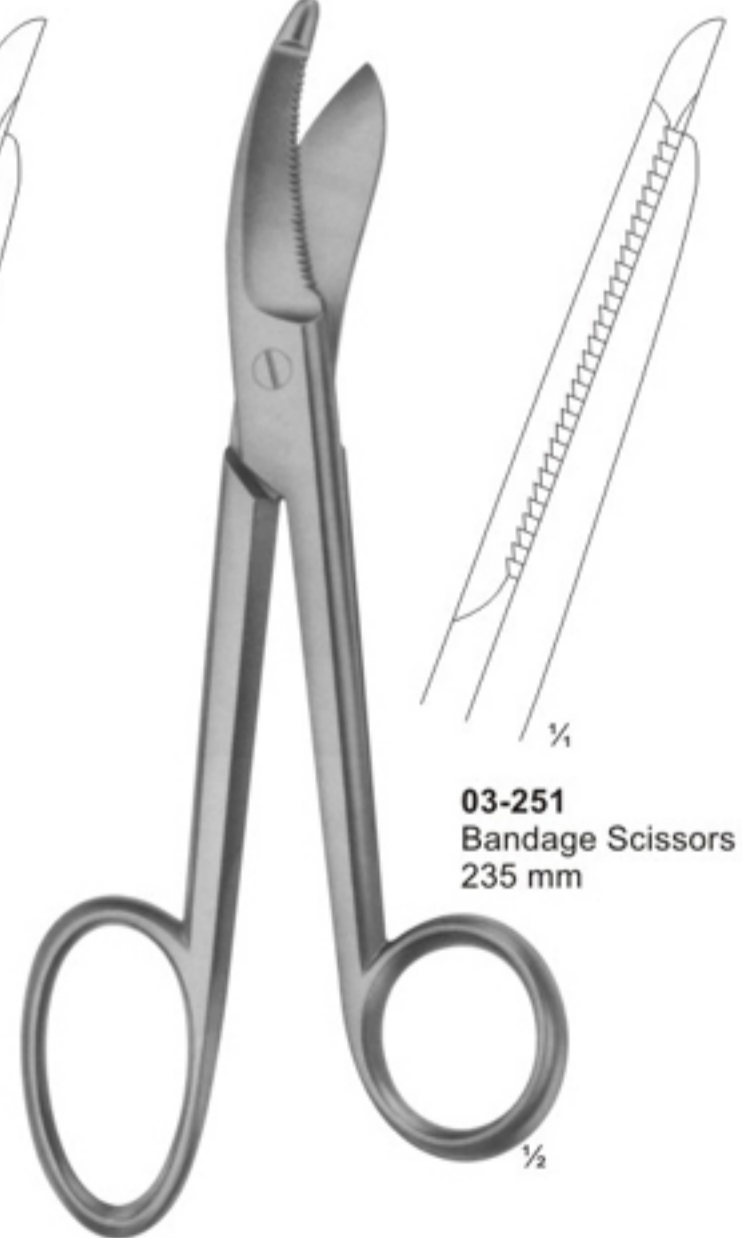

03-251
Bandage Scissors
235 mm

Forceps for grasping tissue, tumors etc.

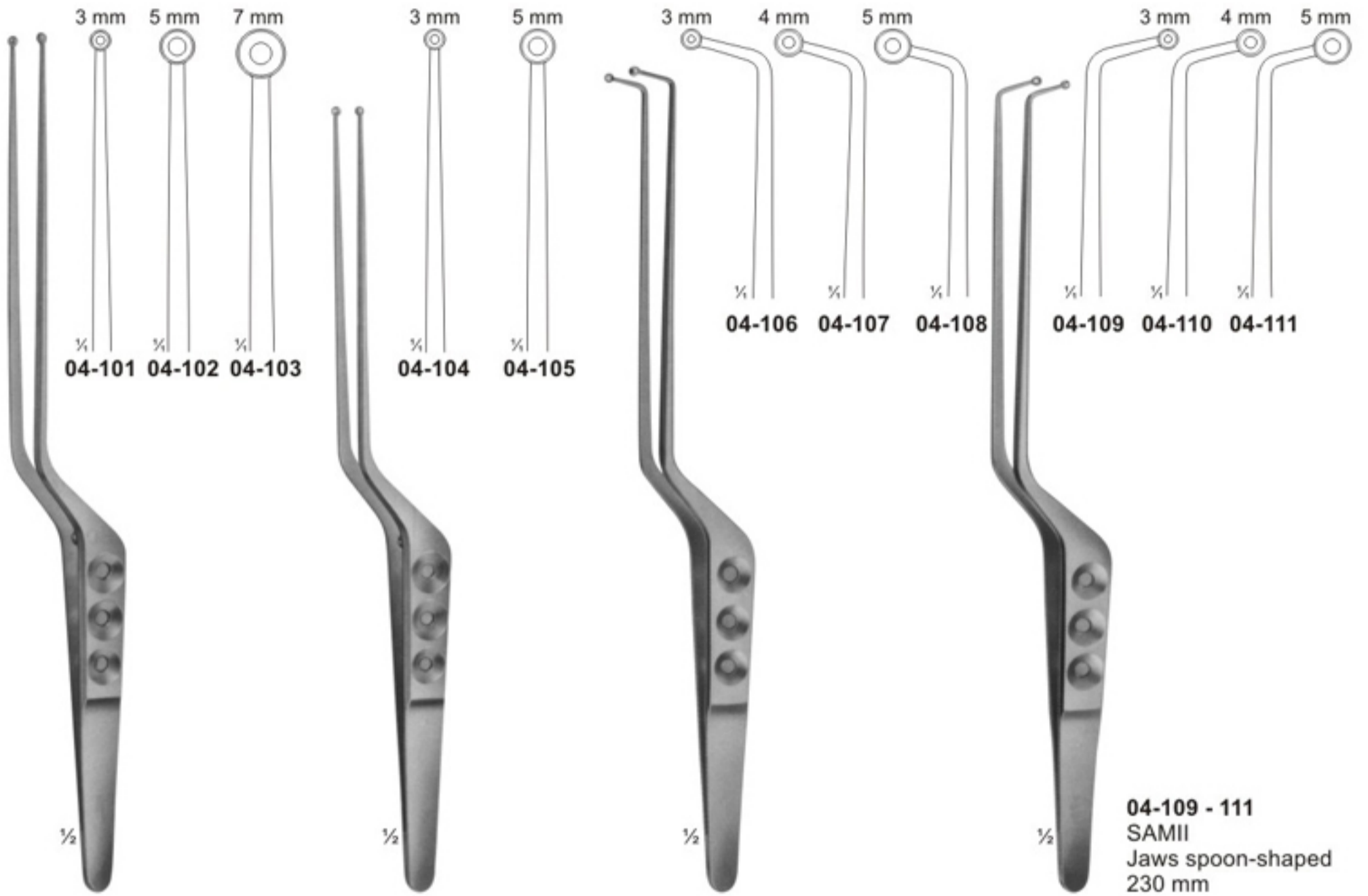

04-101 - 103
YASARGIL-SAMII
Jaws spoon-shaped
240 mm

04-104 - 105
YASARGIL
Jaws spoon-shaped
220 mm

04-106 - 108
SAMII
Jaws spoon-shaped
230 mm

04-109 - 111
SAMII
Jaws spoon-shaped
230 mm

04-112
HUNT
Tumor-and
vessel forceps
200 mm

1/2

04-113
HUNT
Tumor-and
vessel forceps
200 mm

1/2

04-114
YASARGIL
Tumor-and
vessel forceps
200 mm

1/2

Delicate Dissecting, Microscopic, Sterilizing Forceps

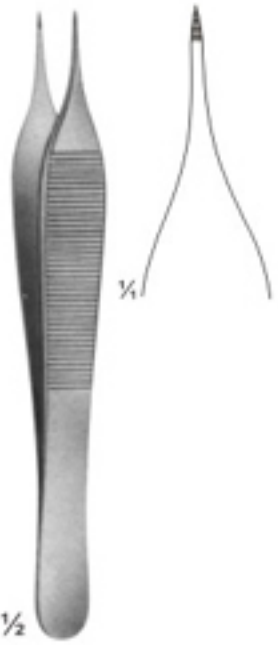

04-115
THORPE
Corneal forceps
120 mm

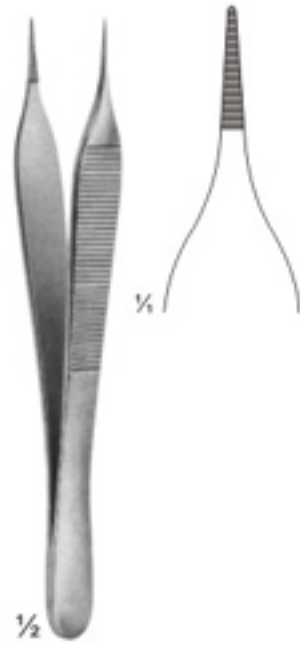

04-116
MICRO-ADSON
120 mm

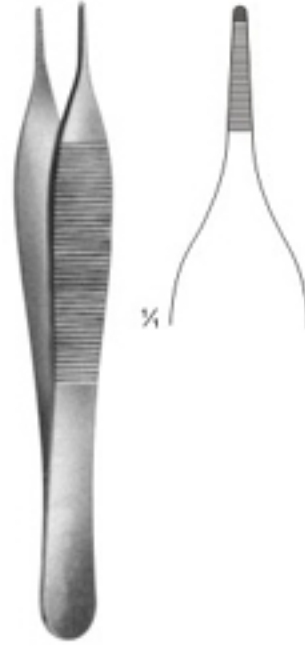

04-117
ADSON
120 mm



04-118
MICRO-ADSON
150 mm

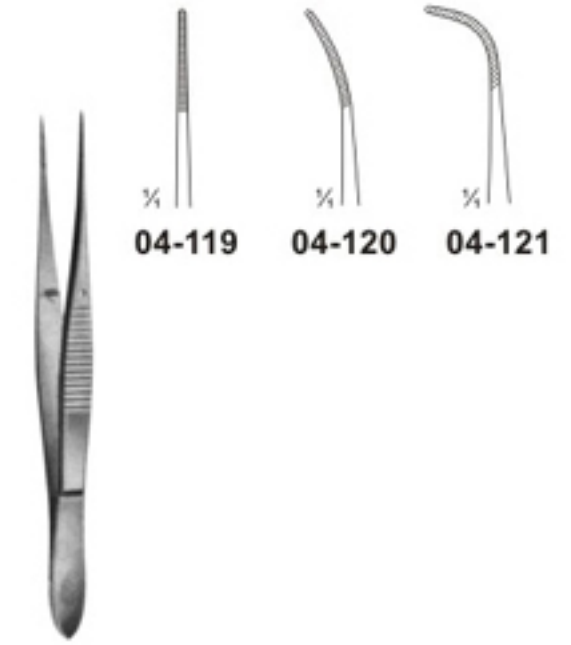

04-119 - 121
100 mm

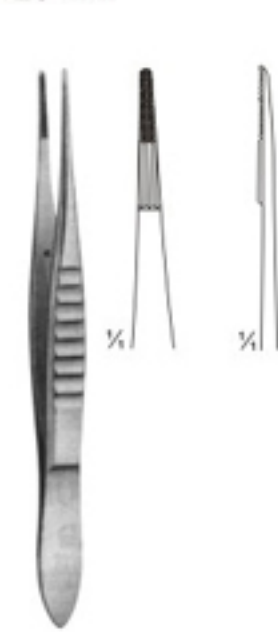

04-122
BONACCOLTO
110 mm

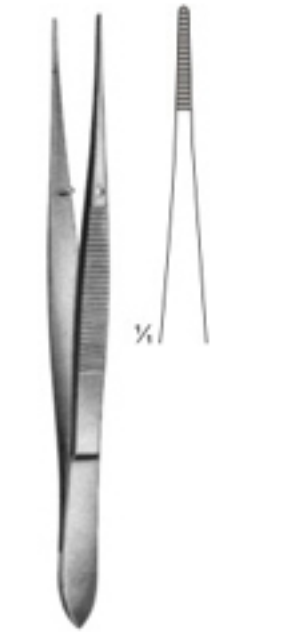

04-123
115 mm

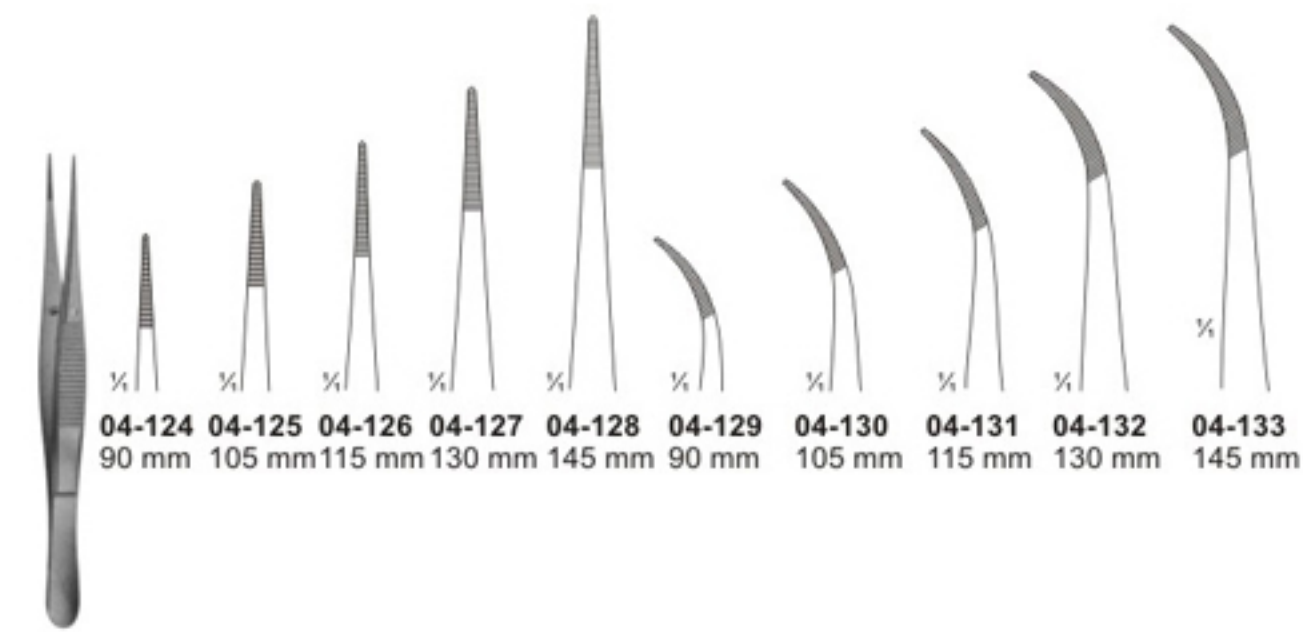

04-124 - 133

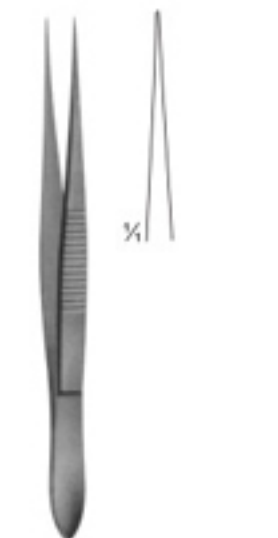

04-134
100 mm

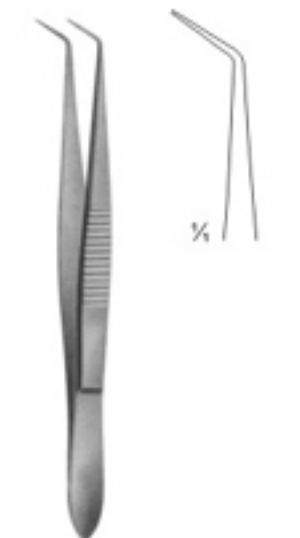

04-135
100 mm



04-136
100 mm

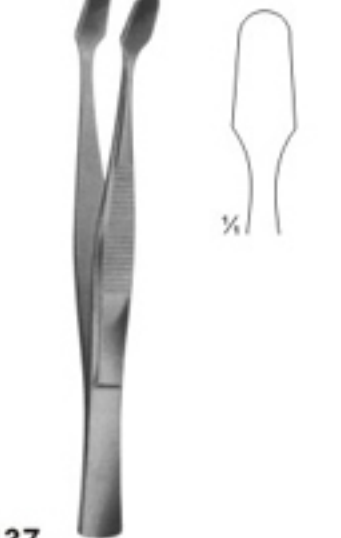

04-137
KUHNE
Cover glass forceps, 105 mm



04-138
160 mm

Delicate Dissecting Forceps

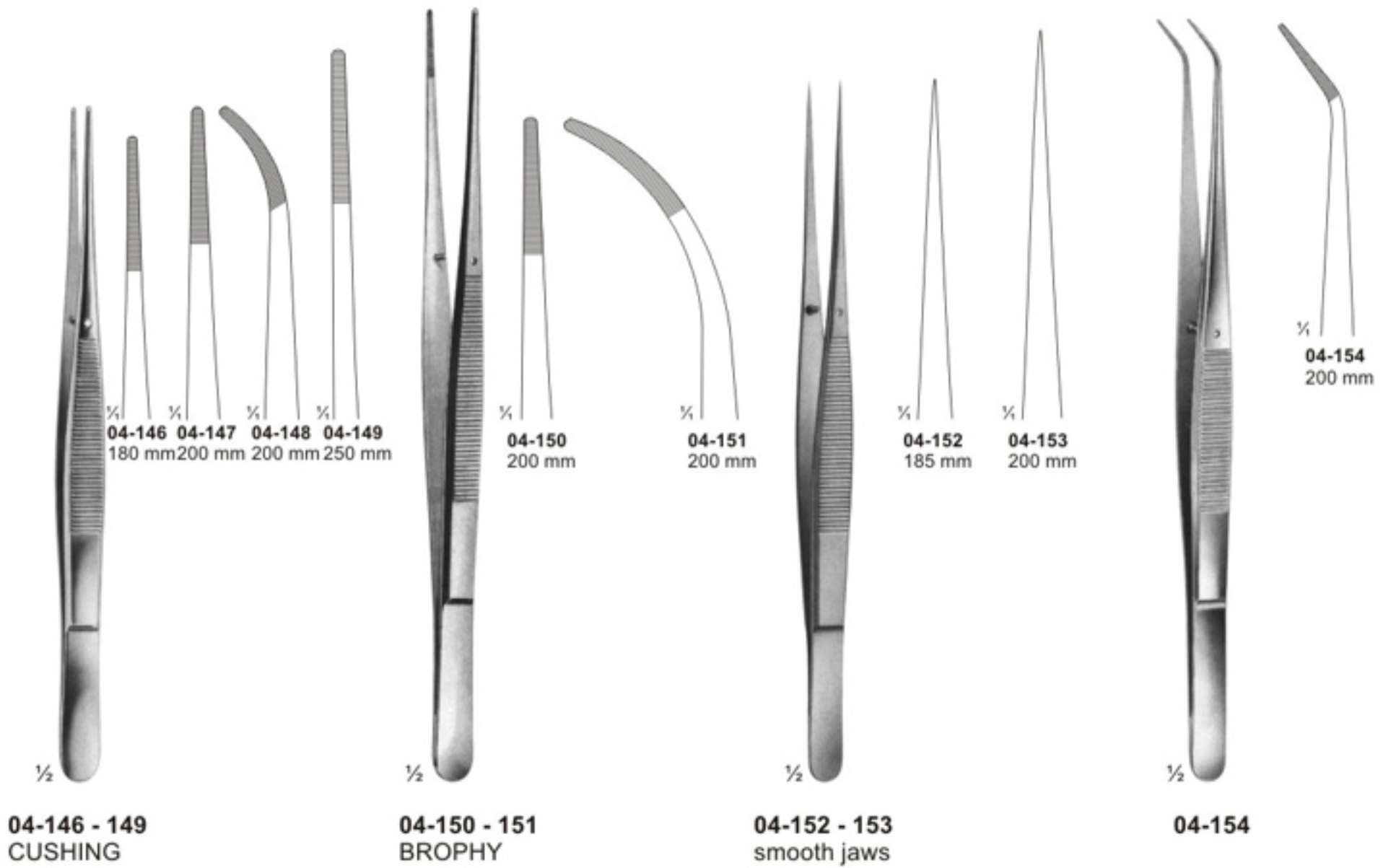
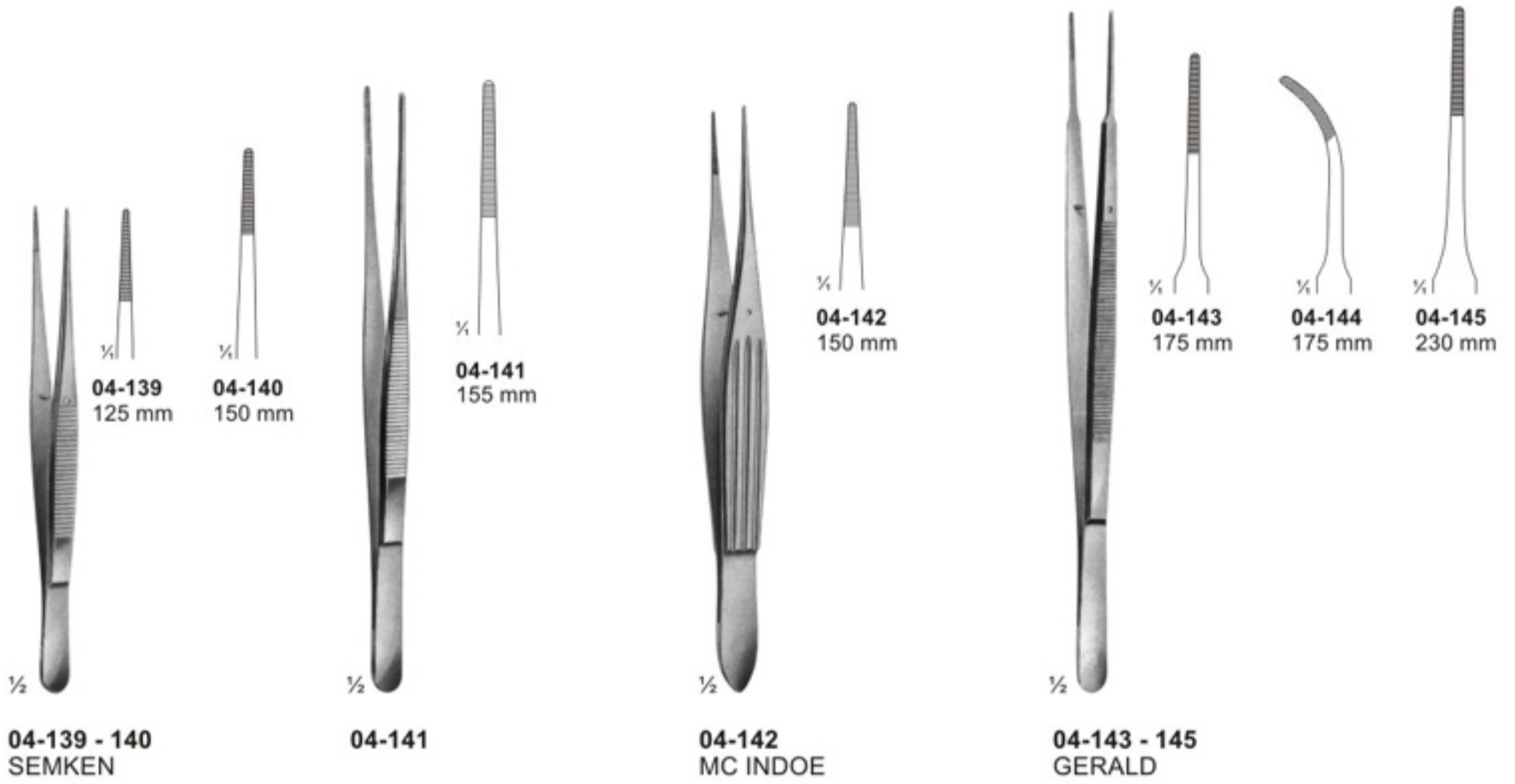

Dissecting Forceps

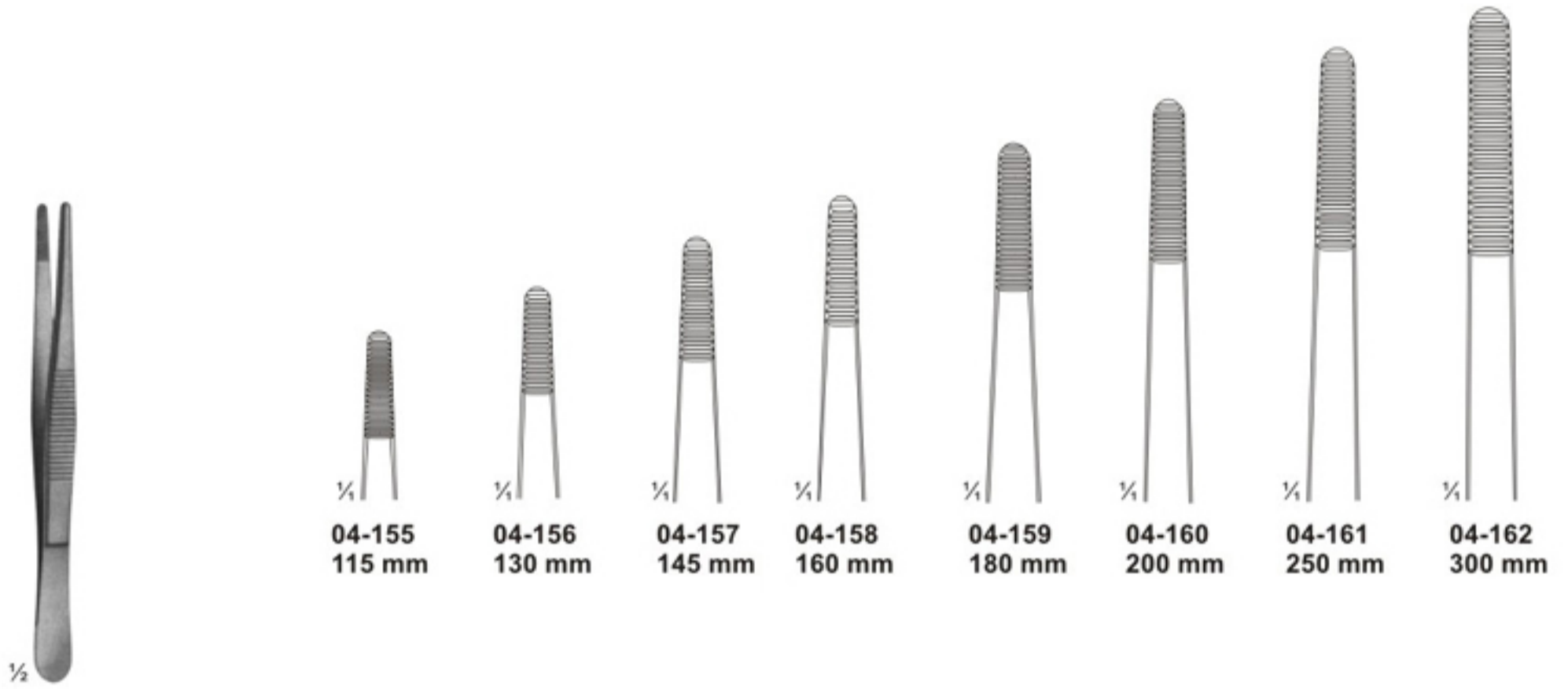

04-155 - 04-162
STANDARD

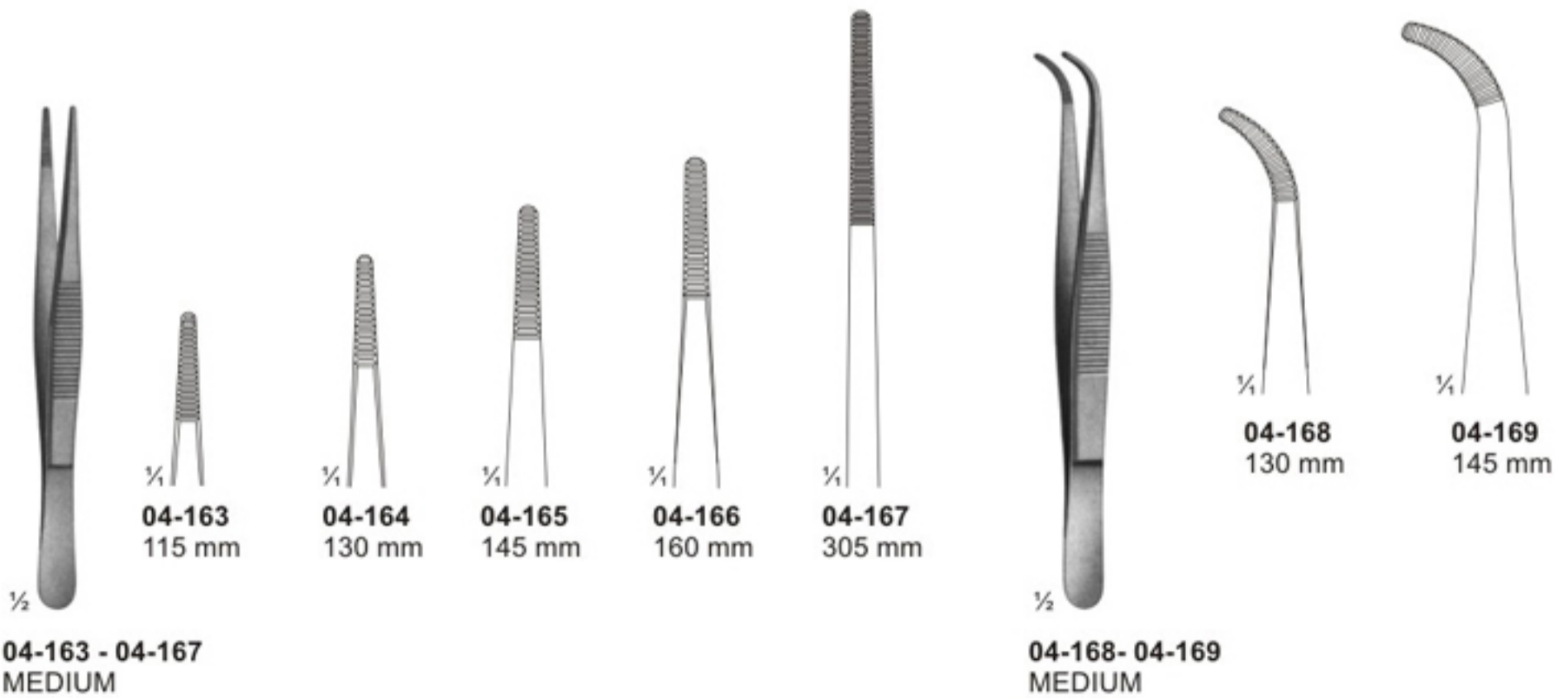

04-163 - 04-167
MEDIUM

04-168 - 04-169
MEDIUM

Forceps

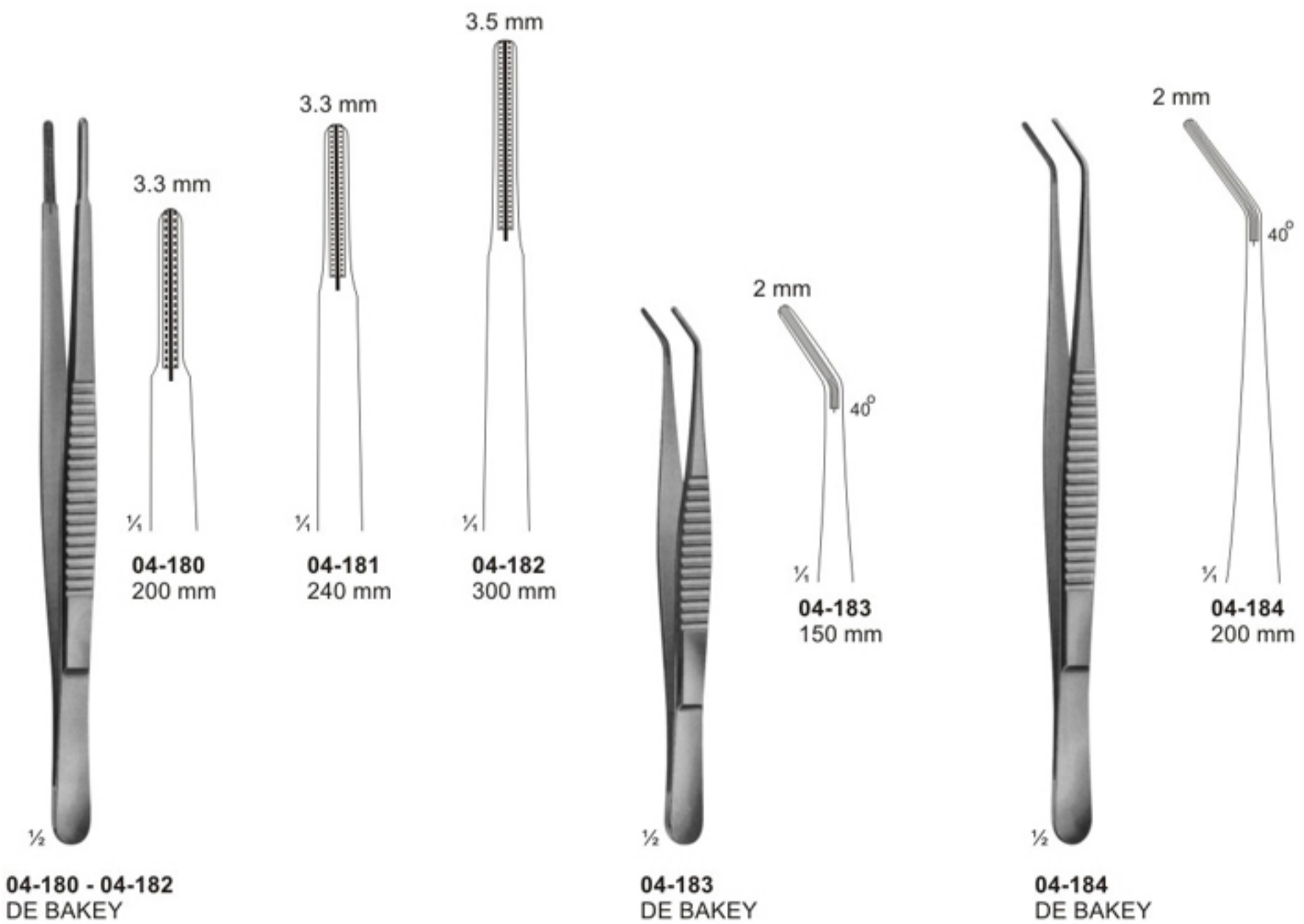
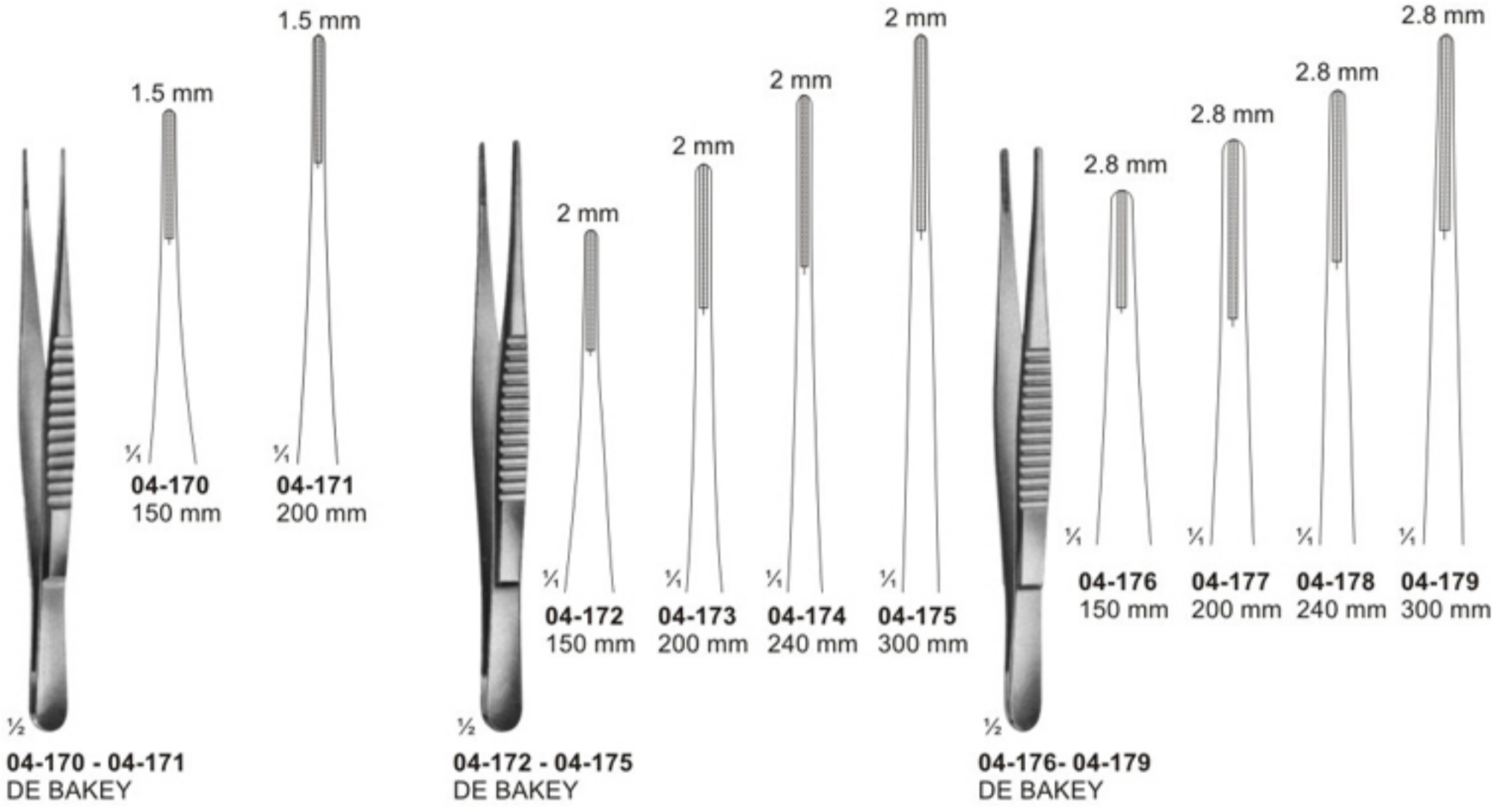

Delicate Tissue Forceps

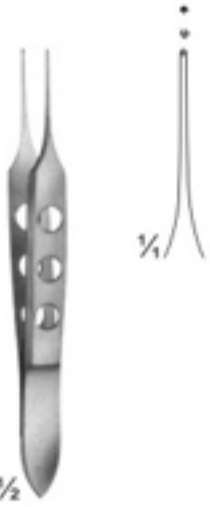

04-185
BISHOP-HARMON
85 mm

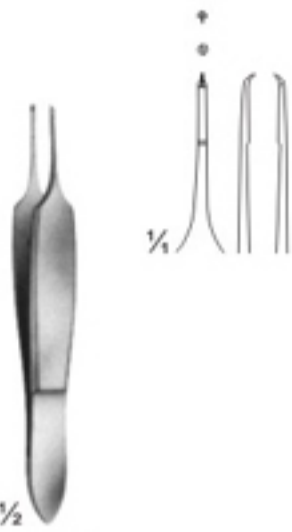

04-186
ST. MARTIN
80 mm

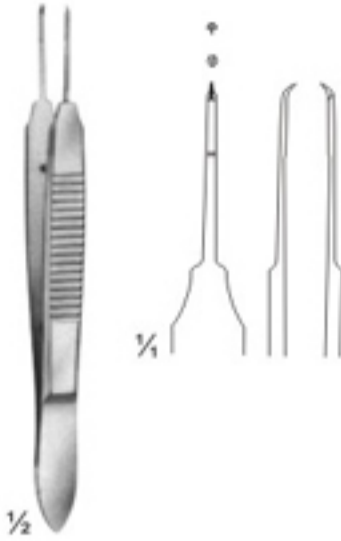

04-187
CASTROVIEJO
teeth 0.9 mm
100 mm

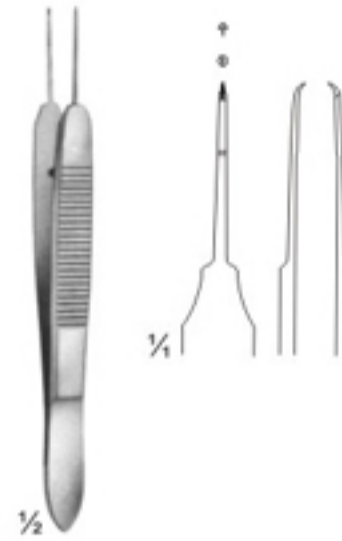

04-188
CASTROVIEJO
teeth 0.5 mm
100 mm

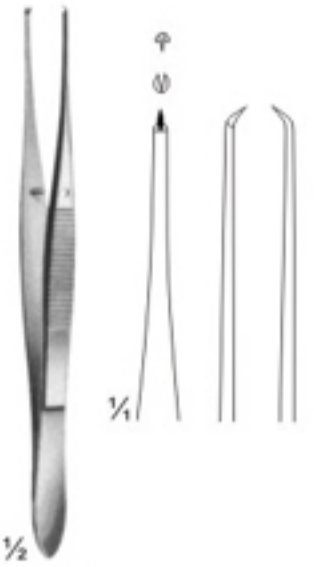

04-189
ELSCHING
110 mm

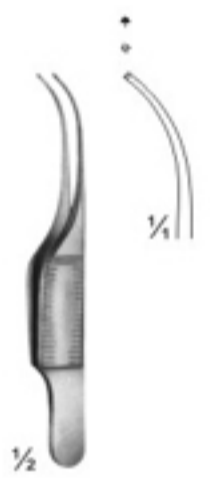

04-190
GILL
75 mm



04-191
GILL - HESS
75 mm

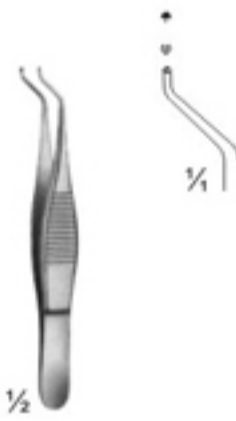

04-192
HESS
70 mm

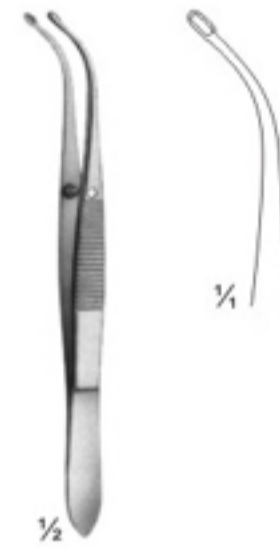

04-193
ARRUGA
100 mm

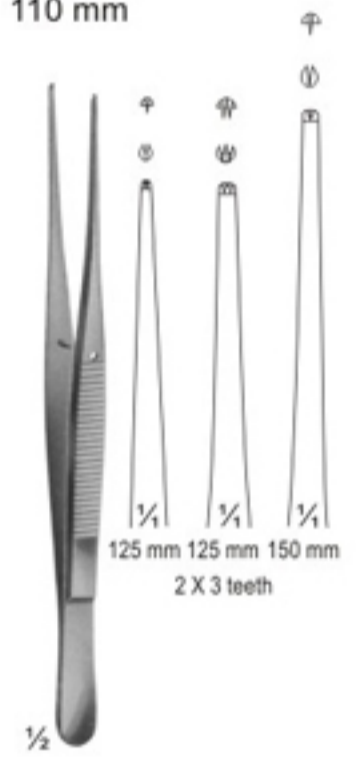

04-194
SEMKEN
125 mm 125 mm 150 mm
2 X 3 teeth



04-195
MICRO-ADSON
120 mm

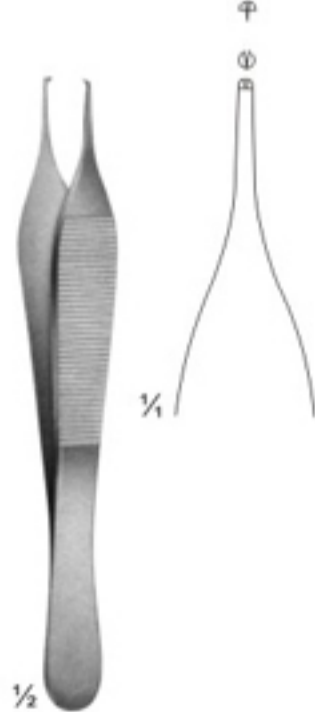

04-196
ADSON
120 mm



04-197
ADSON
120 mm



04-198
ADSON
120 mm

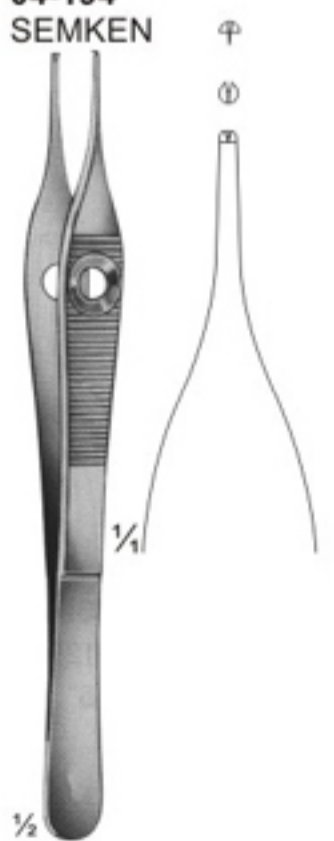

04-199
ADSON
150 mm

Tissue Forceps

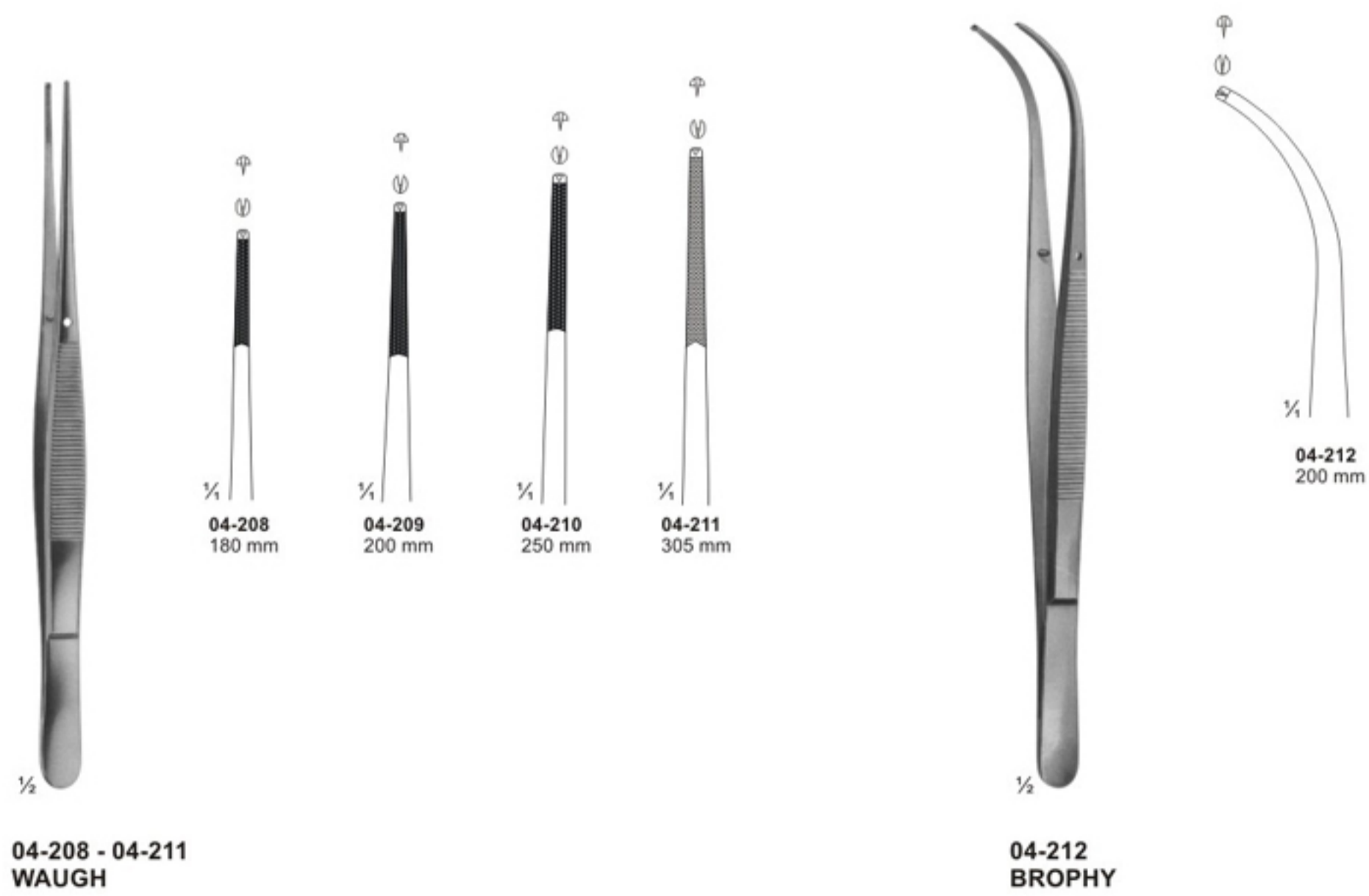
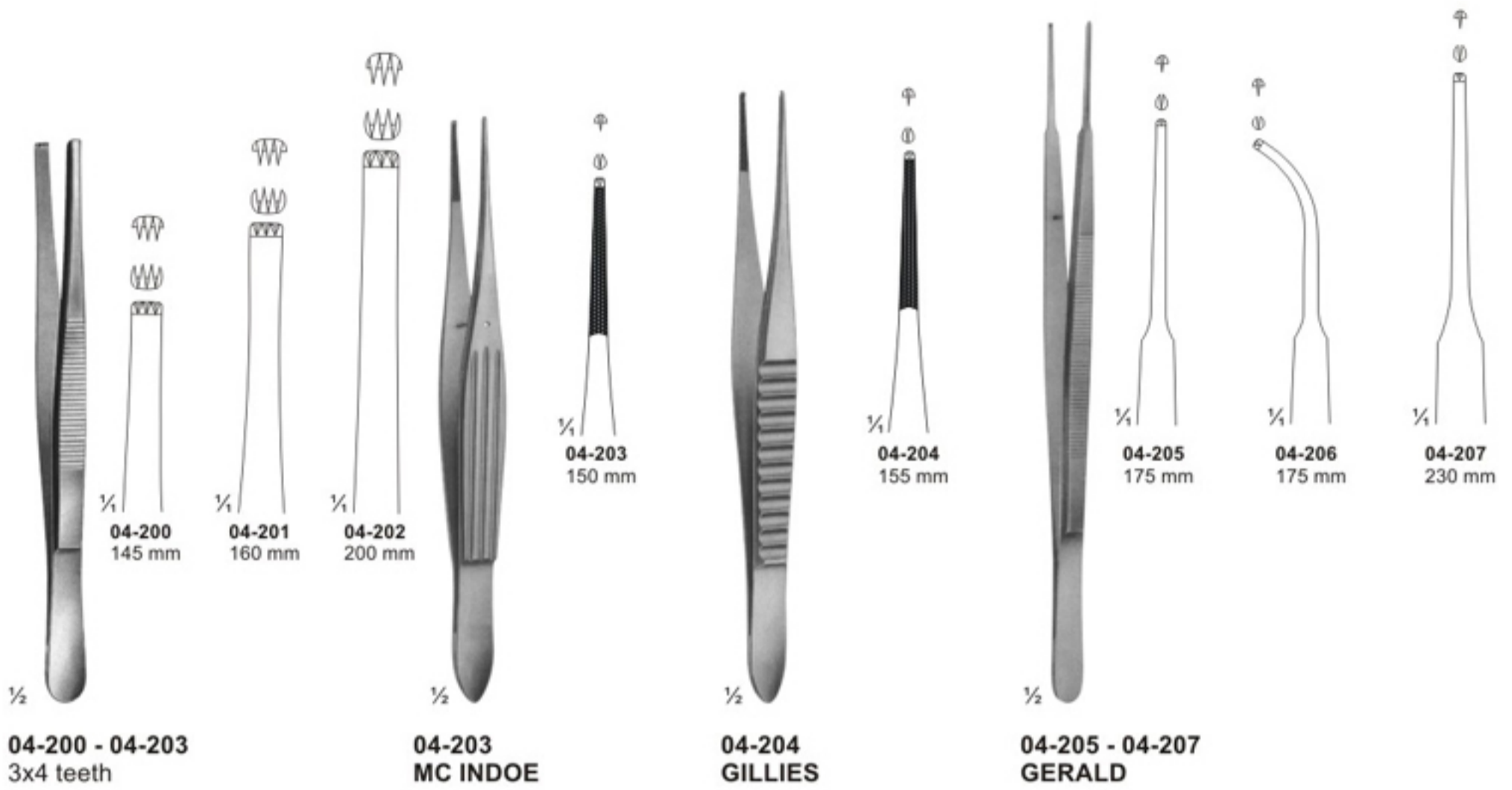

Tissue Forceps

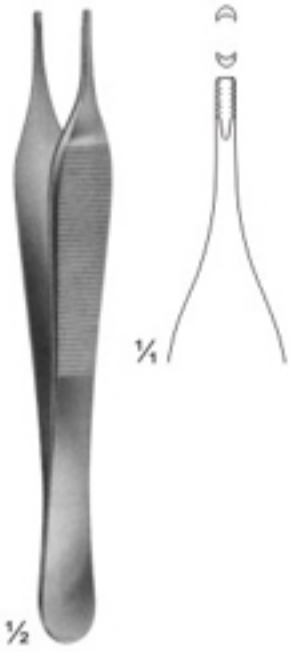

**04-213
ADSON - BROWN
Non-traumatic
120 mm**

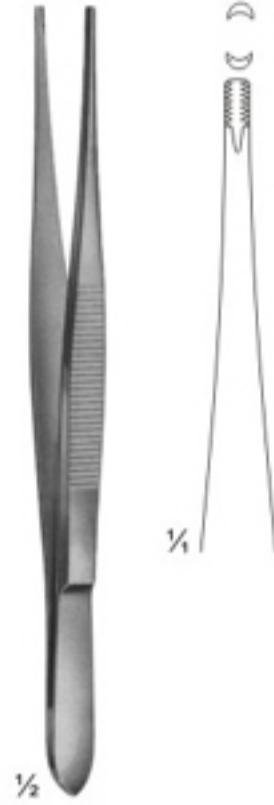

**04-214
BROWN
120 mm**



**04-215
GRAEFE
110 mm**

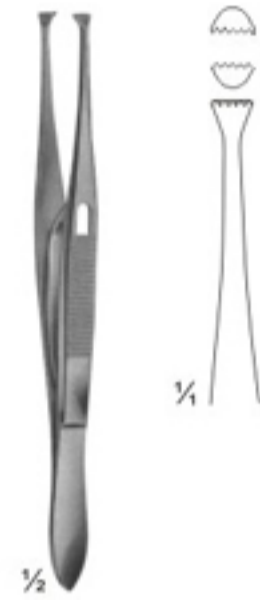

**04-216
GRAEFE
With Catch
110 mm**

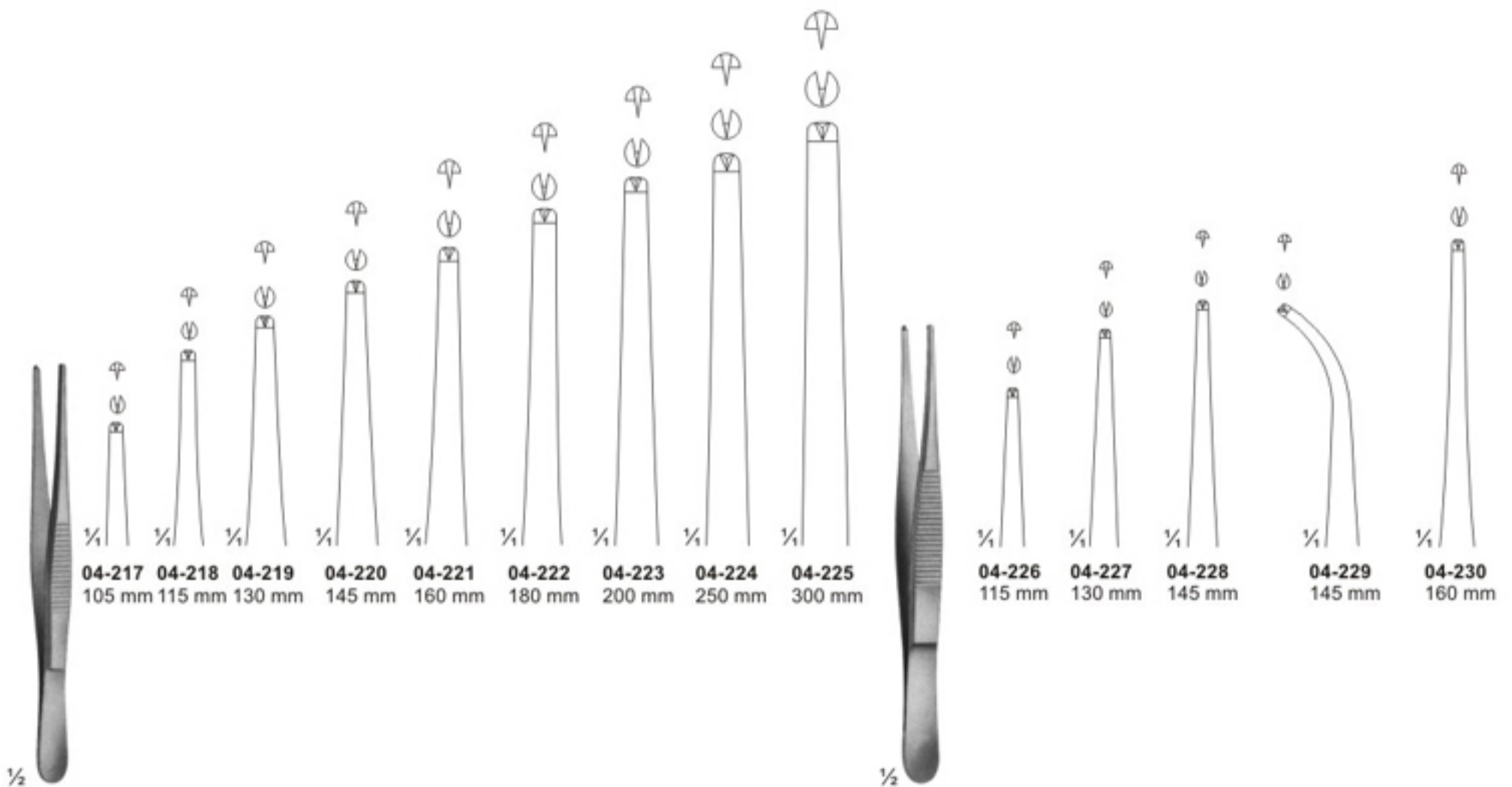

**04-217 - 04-225
STANDARD**

**04-226 - 04-230
GRAEFE
110 mm**

Forceps, Bayonet - Shaped

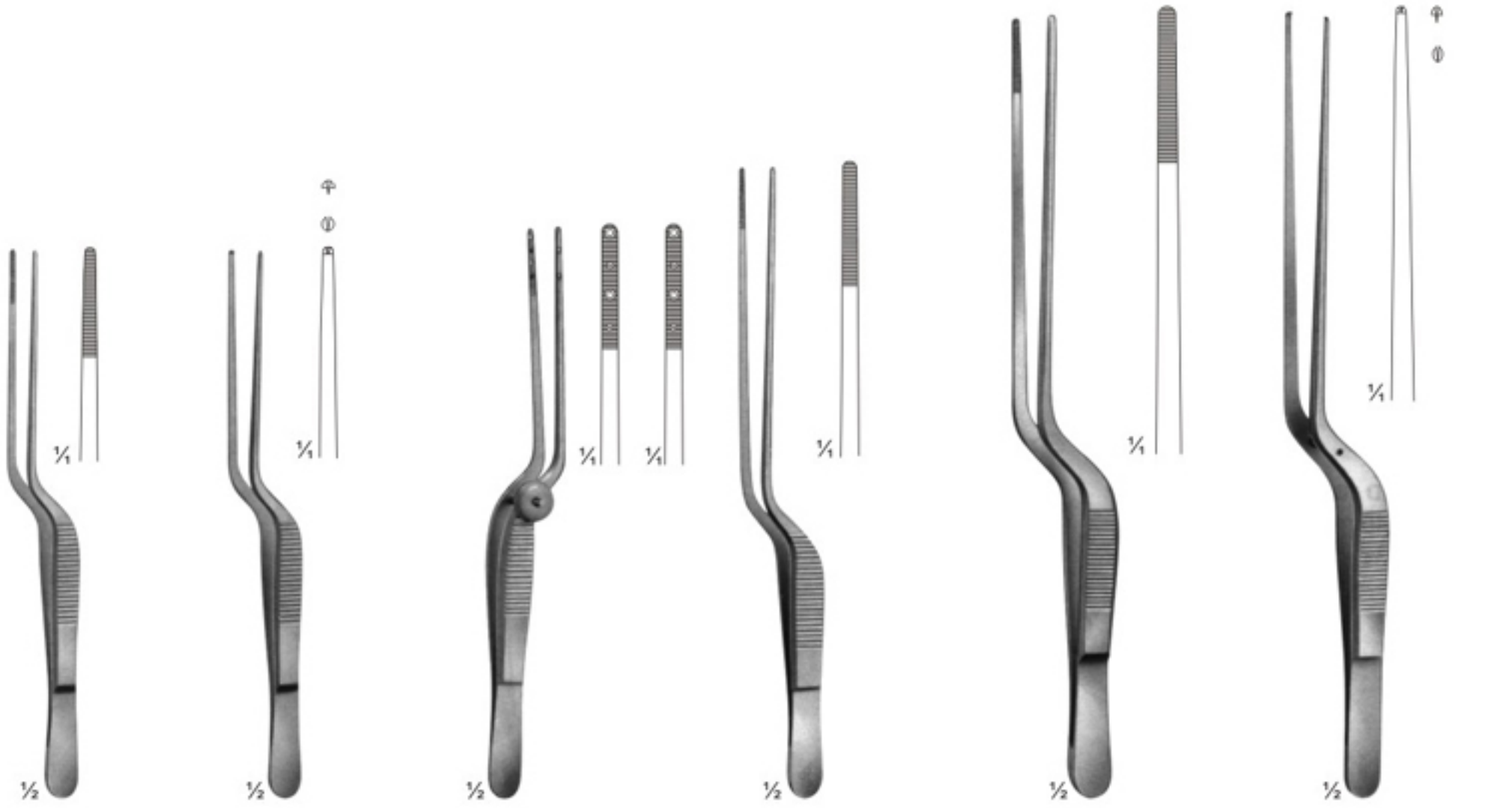

04-231
LUCAE
140 mm

04-232
LUCAE
1x2 teeth
140 mm

04-233
COTTLE
Forceps with
jaws toothed
and serrated
140 mm

04-234
JANSEN
160 mm

04-235
GRUENWALD
200 mm

04-236
1x2 teeth
200 mm

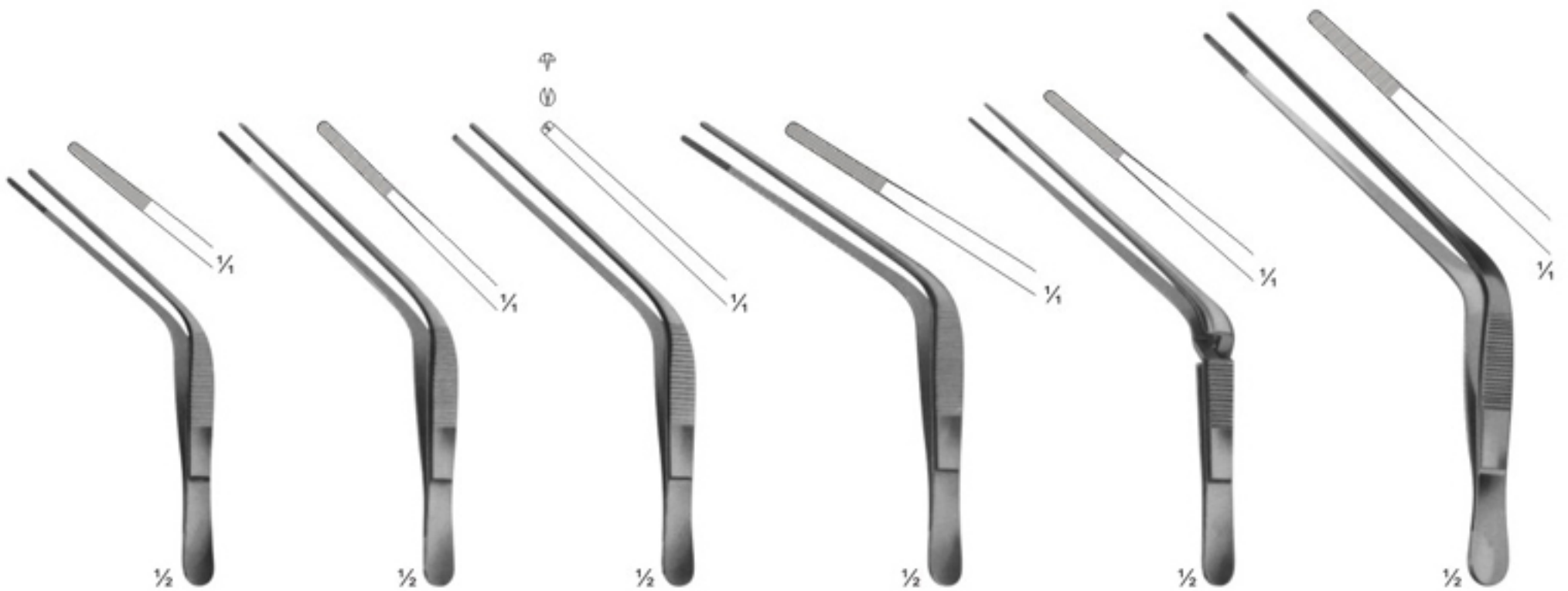

04-237
TROELTSCH
100 mm

04-238
TROELTSCH
115 mm

04-239
TROELTSCH
1X2 teeth
115 mm

04-240
WILDE
115 mm

04-241
TROELTSCH
Cross action
120 mm

04-242
TROELTSCH
140 mm

Tissue Forceps, Lung Dissecting Forceps

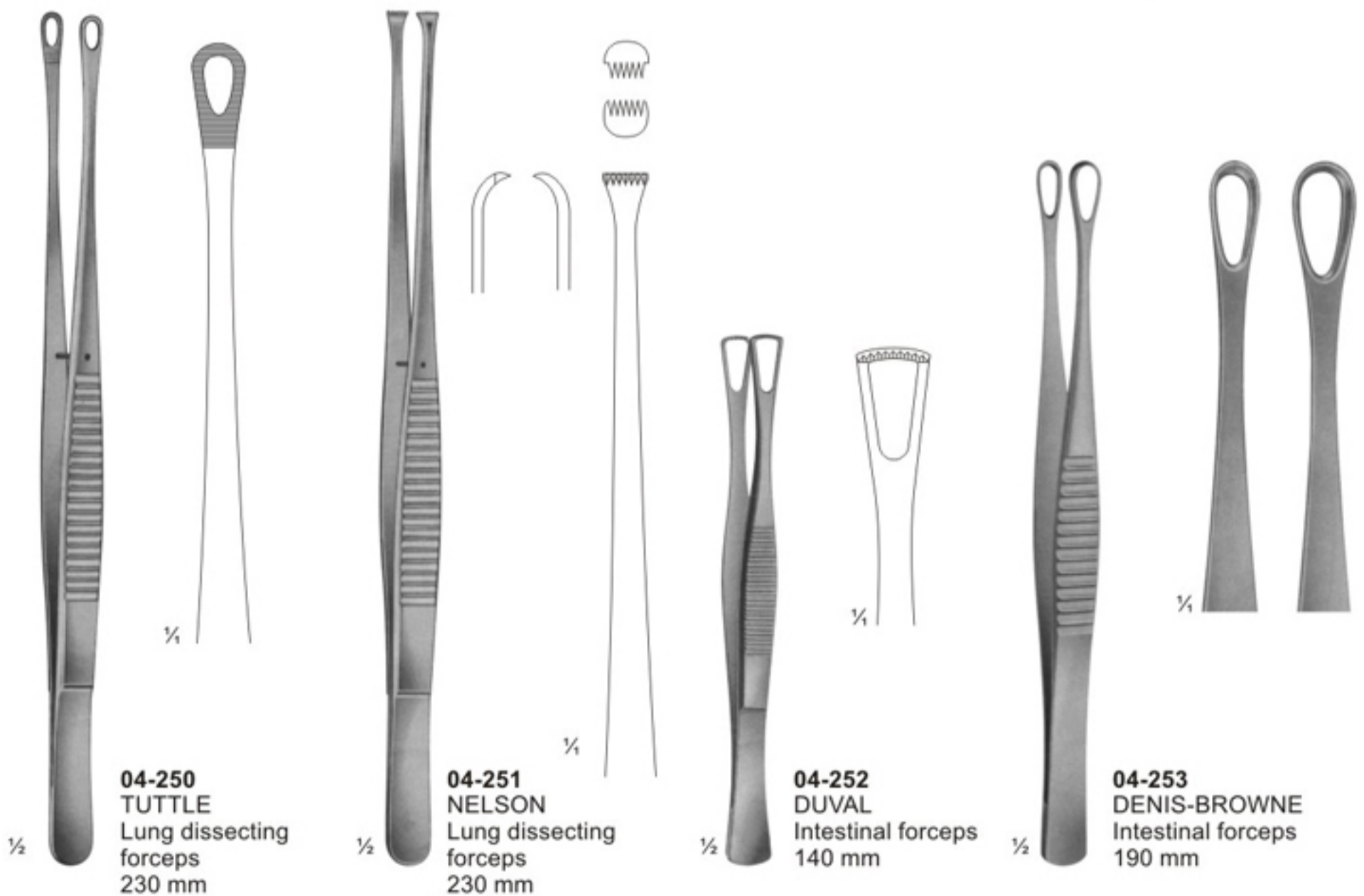
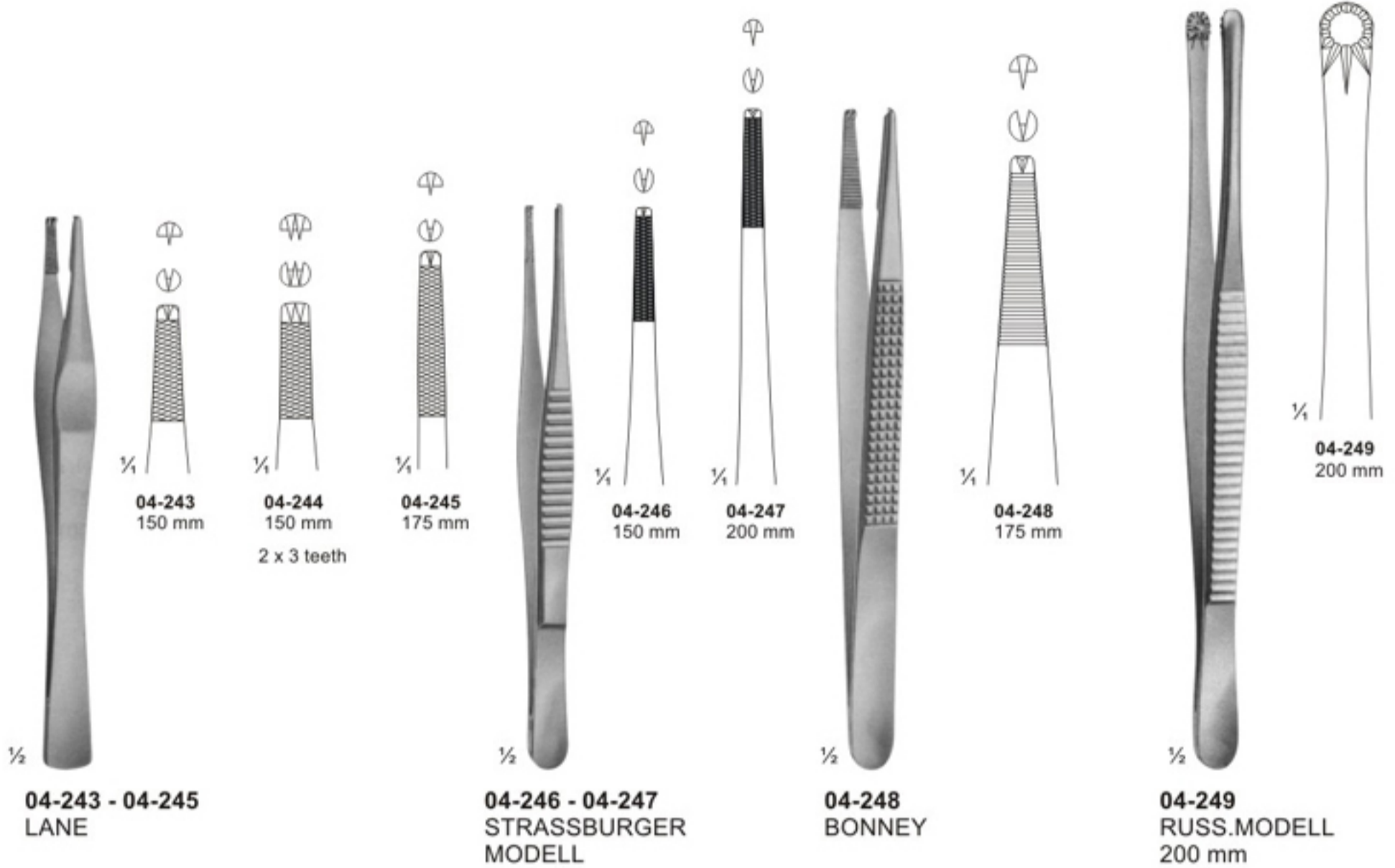

Splinter and Cilia Forceps

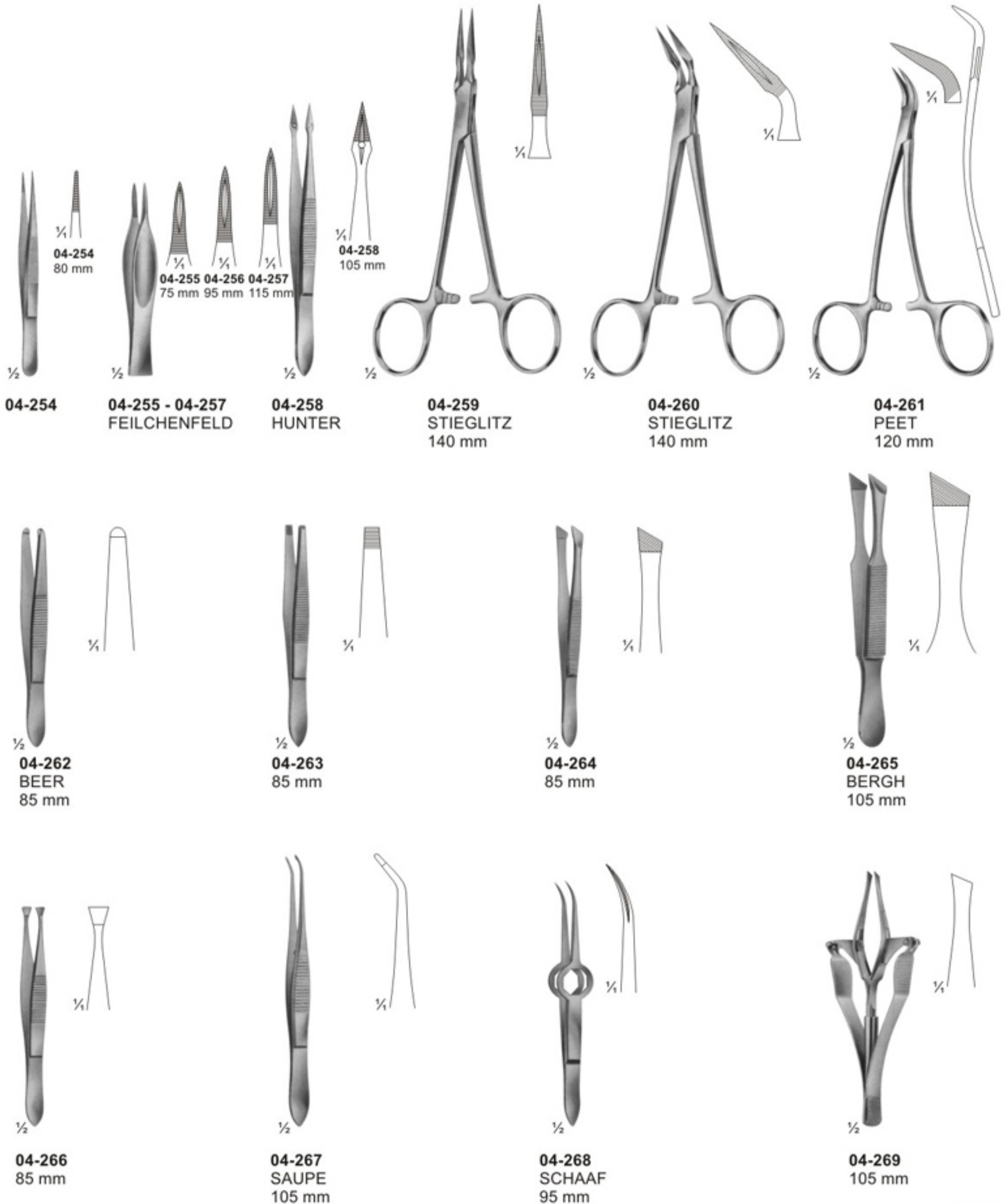

Sponge and Dressing Forceps

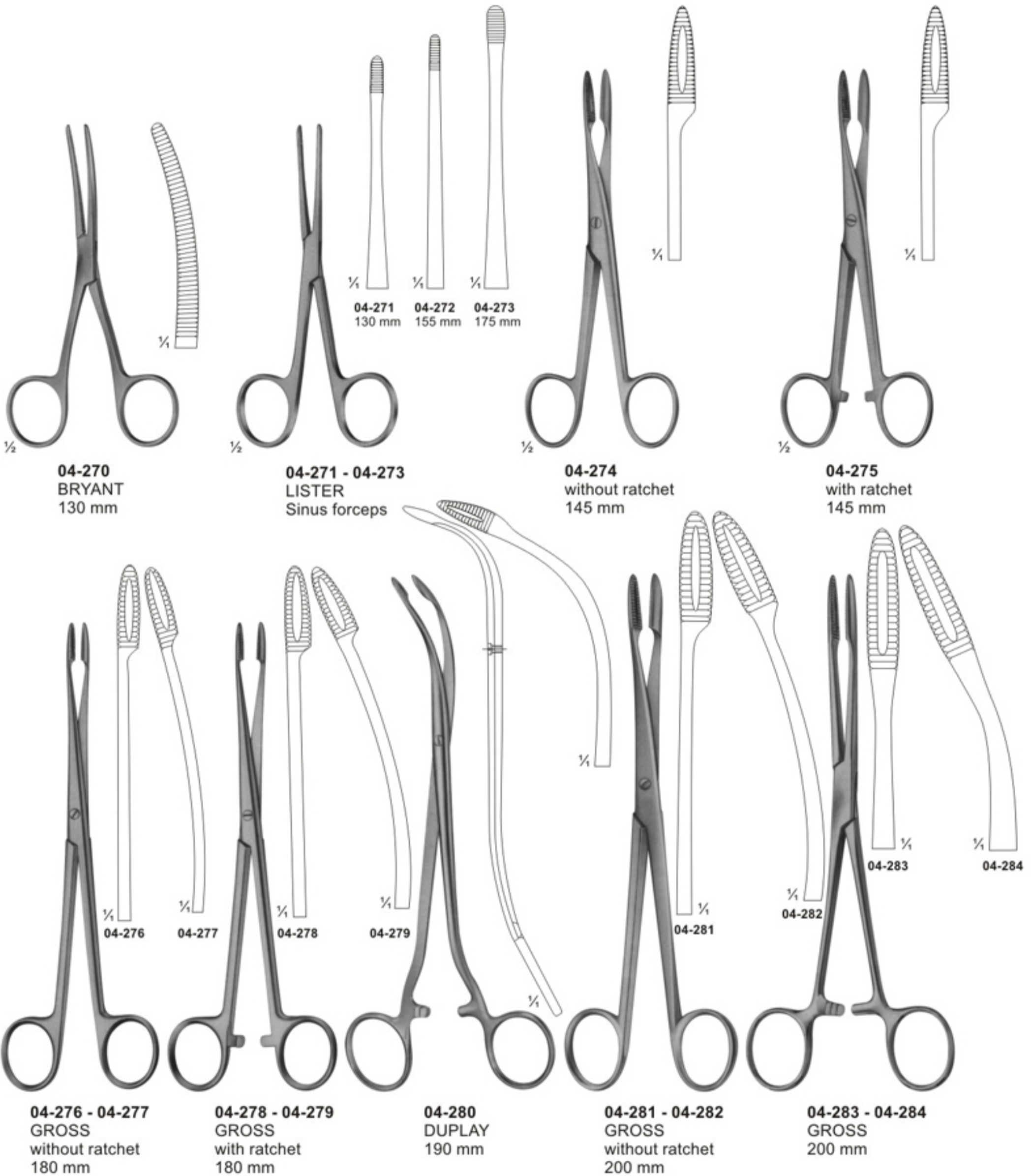

Dressing-, Sponge holding-, Organ- and Tissue Grasping Forceps

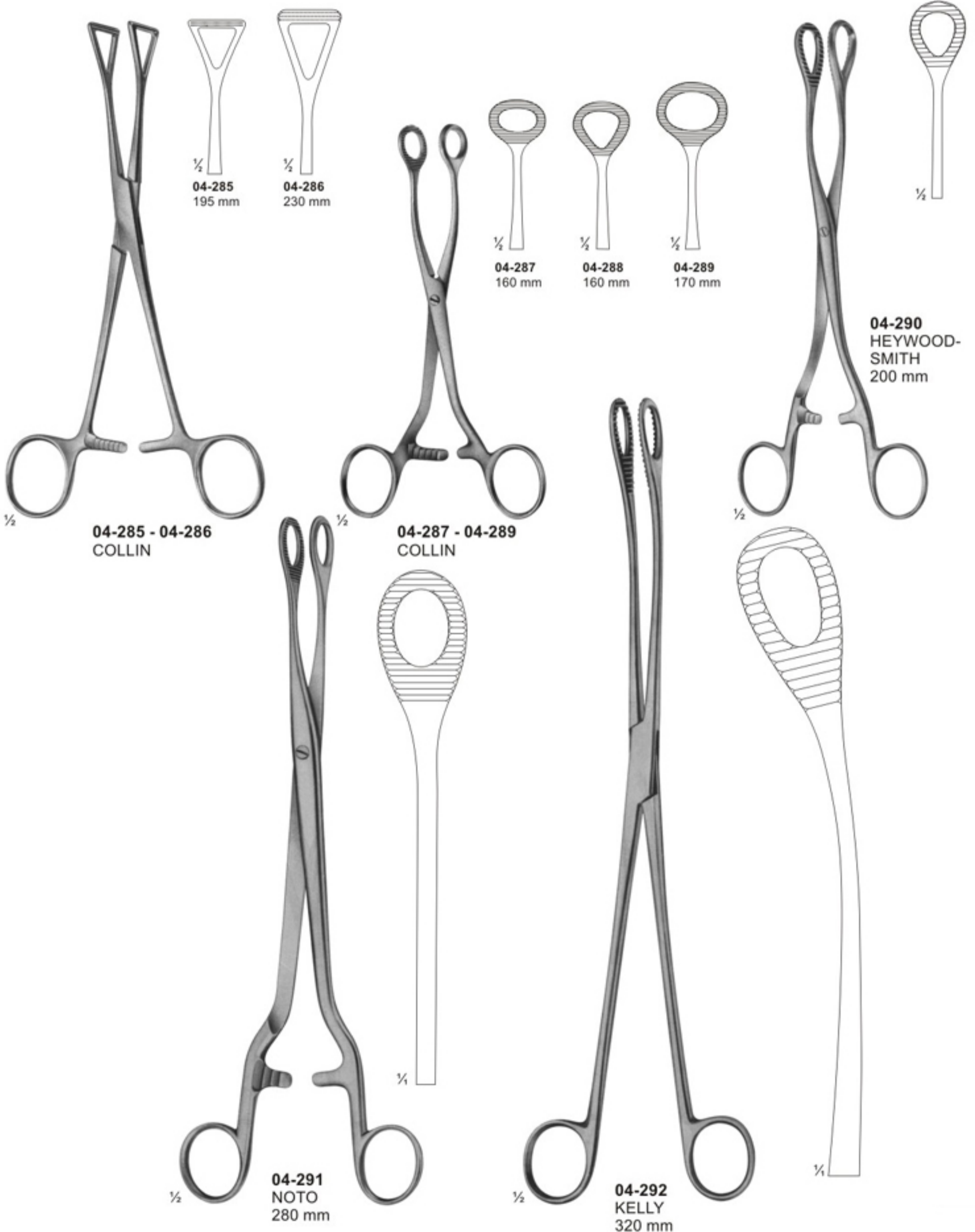

Dressing, Sponge holding, Organ and Tissue Grasping Forceps

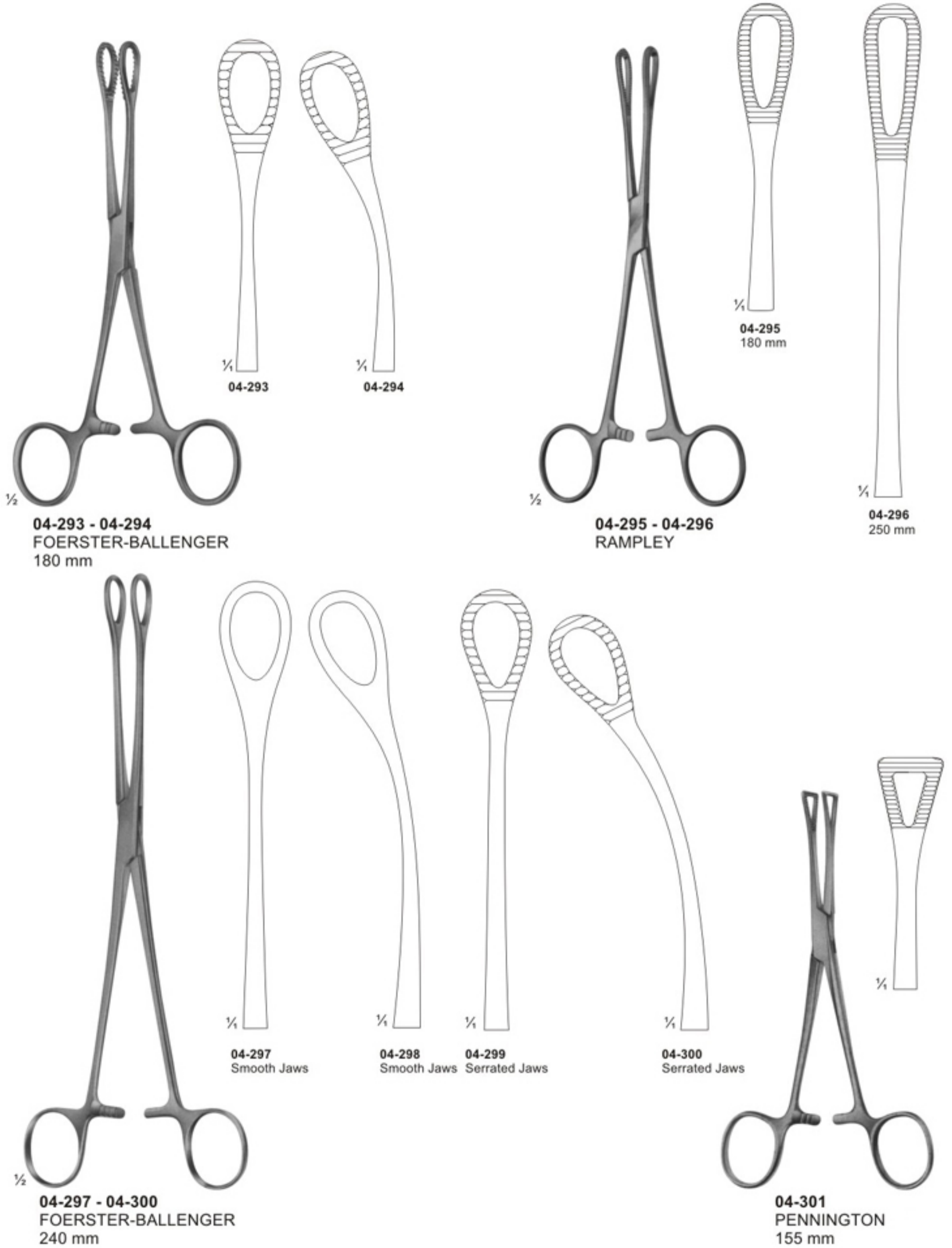

Intestinal Grasping Forceps

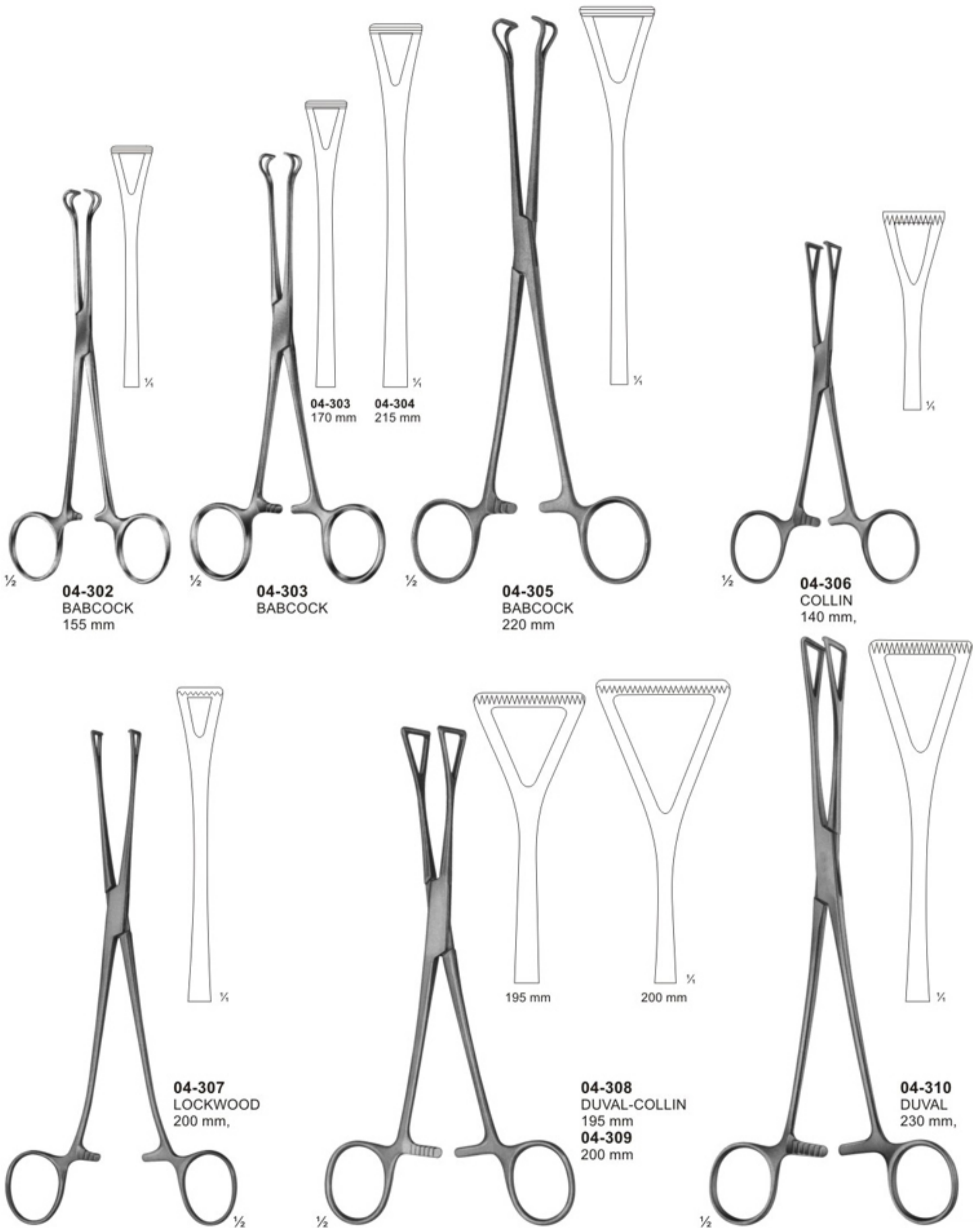

Artery Traction - and Tissue Grasping Forceps

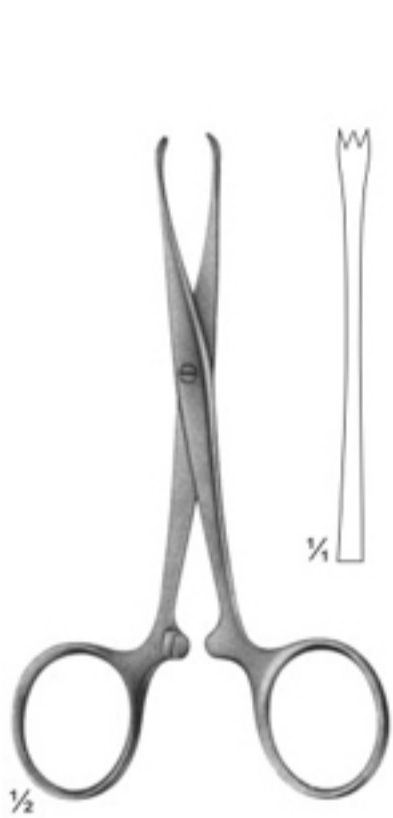

04-311
CHAPUT
 2 x 3 teeth
 125 mm

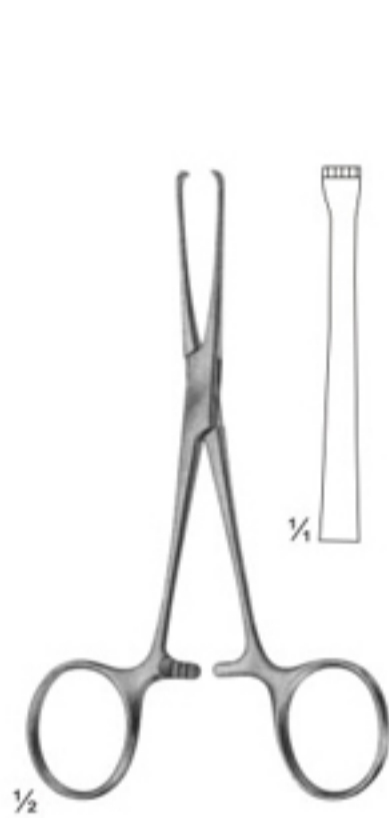

04-312
BABY-ALLIS
 4 x 5 teeth
 130 mm

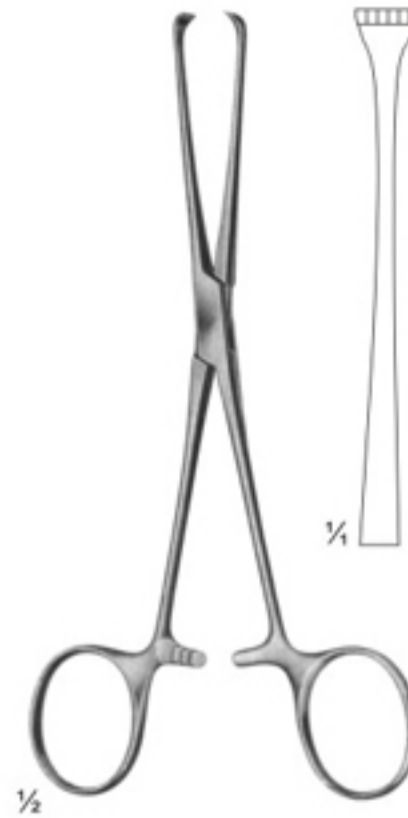

04-313
BOYS-ALLIS
 5 x 6 teeth sharp
 155 mm

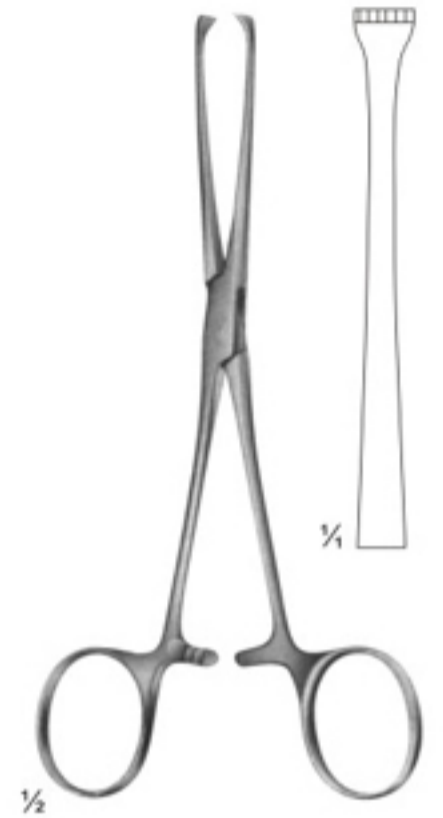

04-314
ALLIS
 5 x 6 teeth
 155 mm



04-315
LAHEY
 155 mm

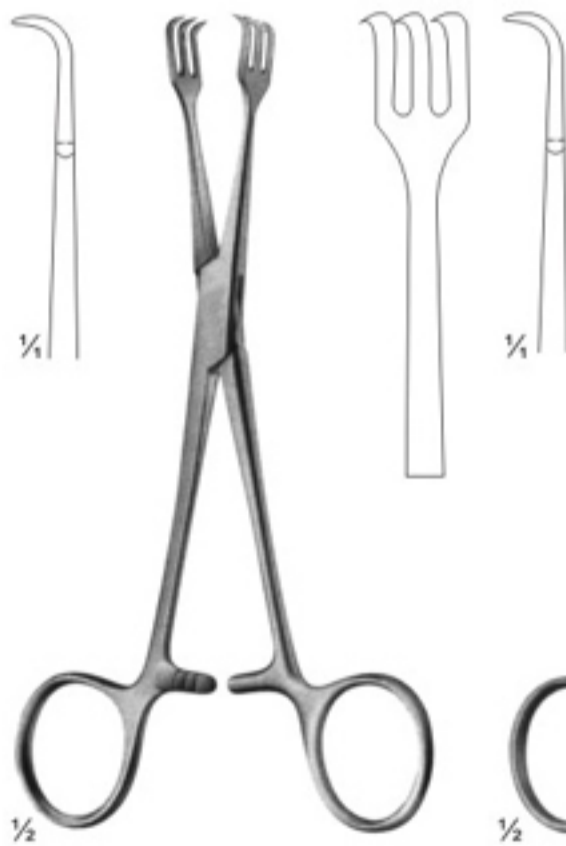

04-316
LAHEY
 155 mm

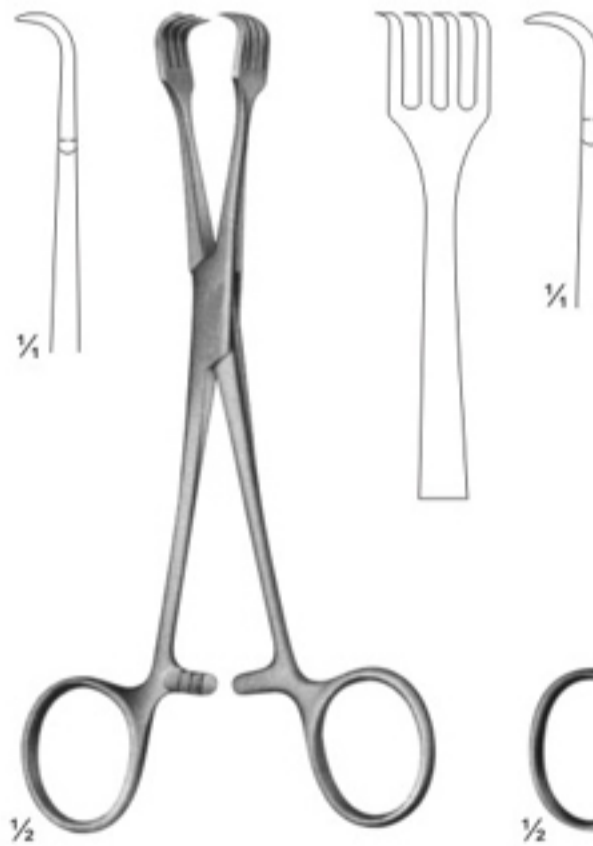

04-317
BRAUN
 155 mm

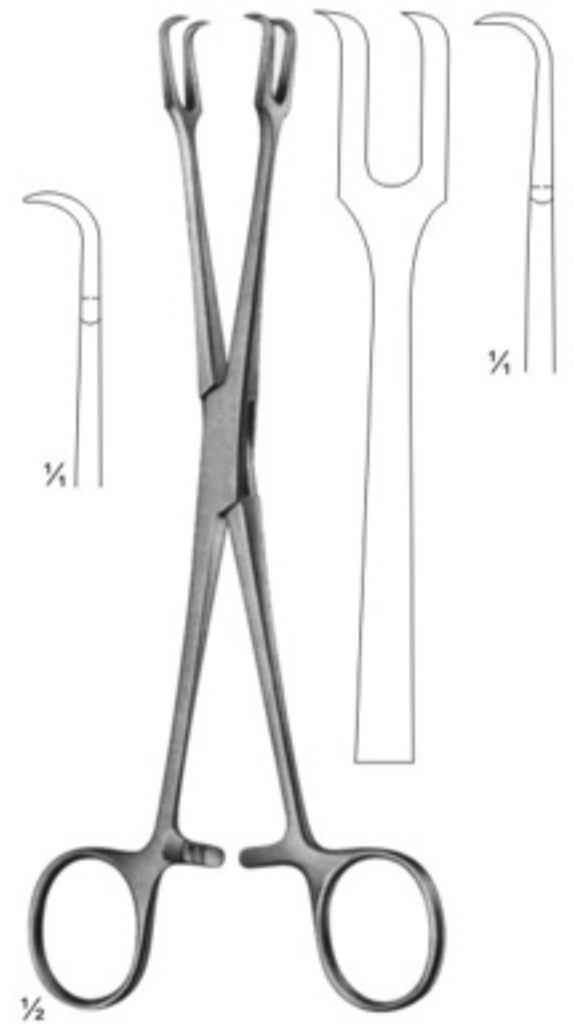





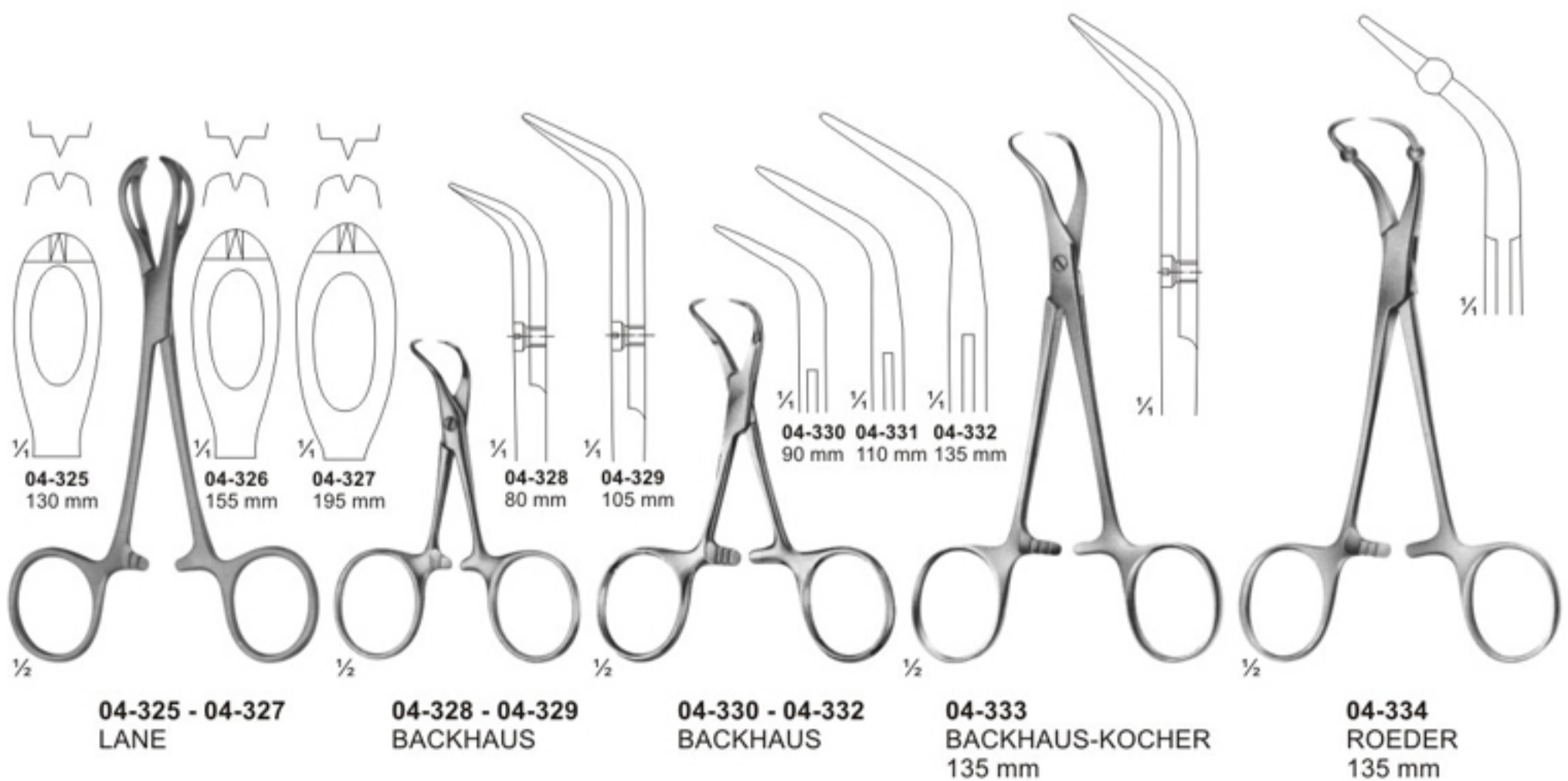
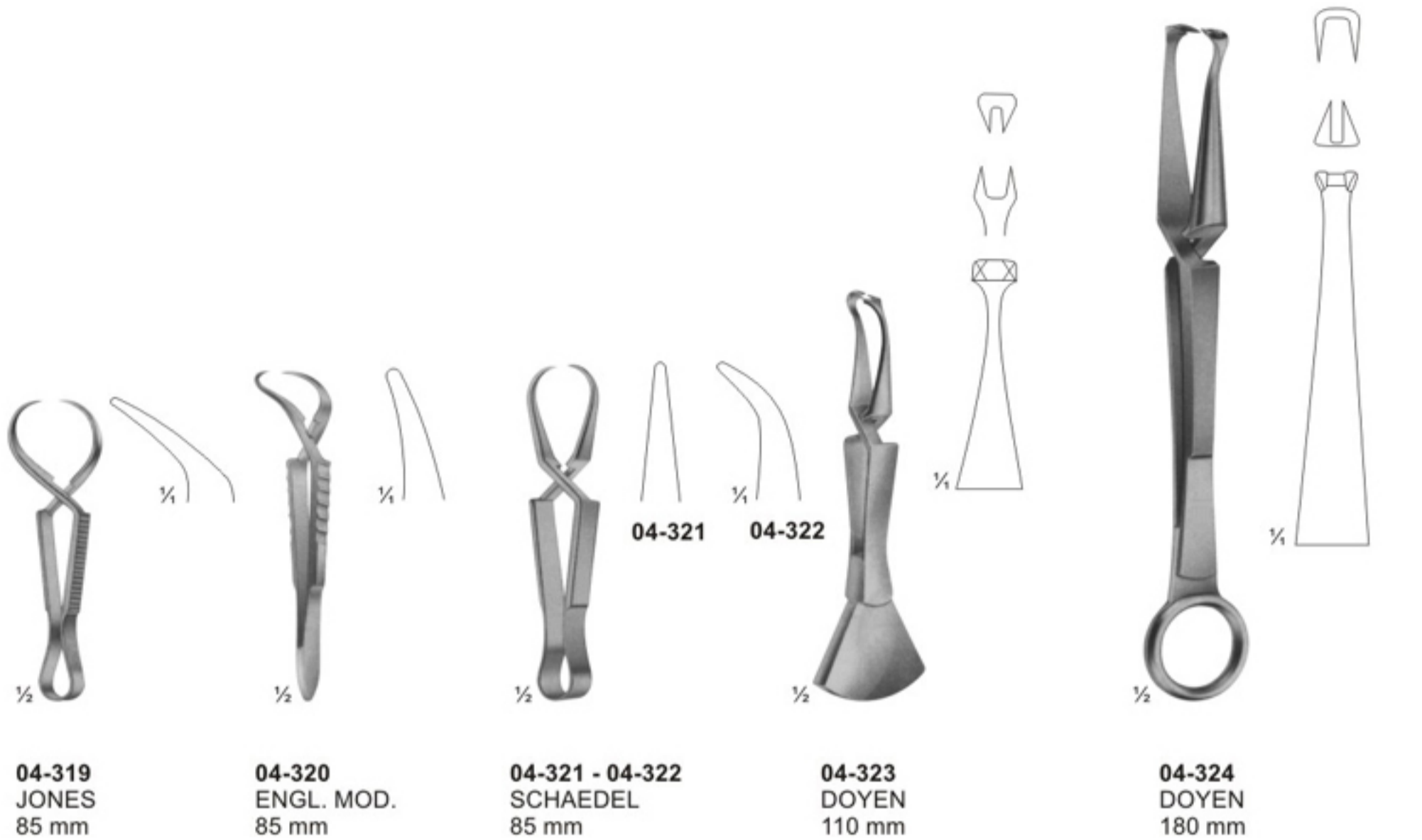

04-318
MUSEUX
 200 mm













Towel Clamps













Muller Vessel Clips and Bulldog Clamps

Closing force

						
04-335 straight	04-336 curved	04-337 curved tips	04-338 angled shaped	04-339 MULLER knee-bent	04-340 Muller Ligature Forceps	Jaw, cross serrated
80g 50g	80g 50g	80g 50g	80g 50g	80g 50g	80g 50g	

											
04-341 35 mm	04-342 35 mm	04-343 45 mm	04-344 45 mm	04-345 04-346 38 mm 48 mm	04-347 04-348 38 mm 48 mm	04-349 58 mm	04-350 58 mm	04-351 - 04-357 91 mm	04-351 38 mm 04-352 48 mm 04-353 56 mm 04-354 63 mm 04-355 70 mm 04-356 80 mm 04-357 91 mm	04-358 DE BAKEY- HESS 20 mm	

									
04-359 length 50 mm jaws 27 mm	04-360 length 48 mm jaws 27 mm	04-361 GLOVER length 57 mm jaws 35 mm	04-362 DE BAKEY length 73 mm jaws 38 mm	04-363 DE BAKEY length 99 mm jaws 63 mm	04-364 DE BAKEY length 95 mm jaws 54 mm	04-365 L. 80 mm	04-366 L. 90 mm	04-367 L. 105 mm	04-368 L. 124 mm
						04-369 L. 78 mm	04-370 L. 86 mm	04-371 L. 97 mm	04-372 L. 114 mm

Delicate Haemostatic Forceps

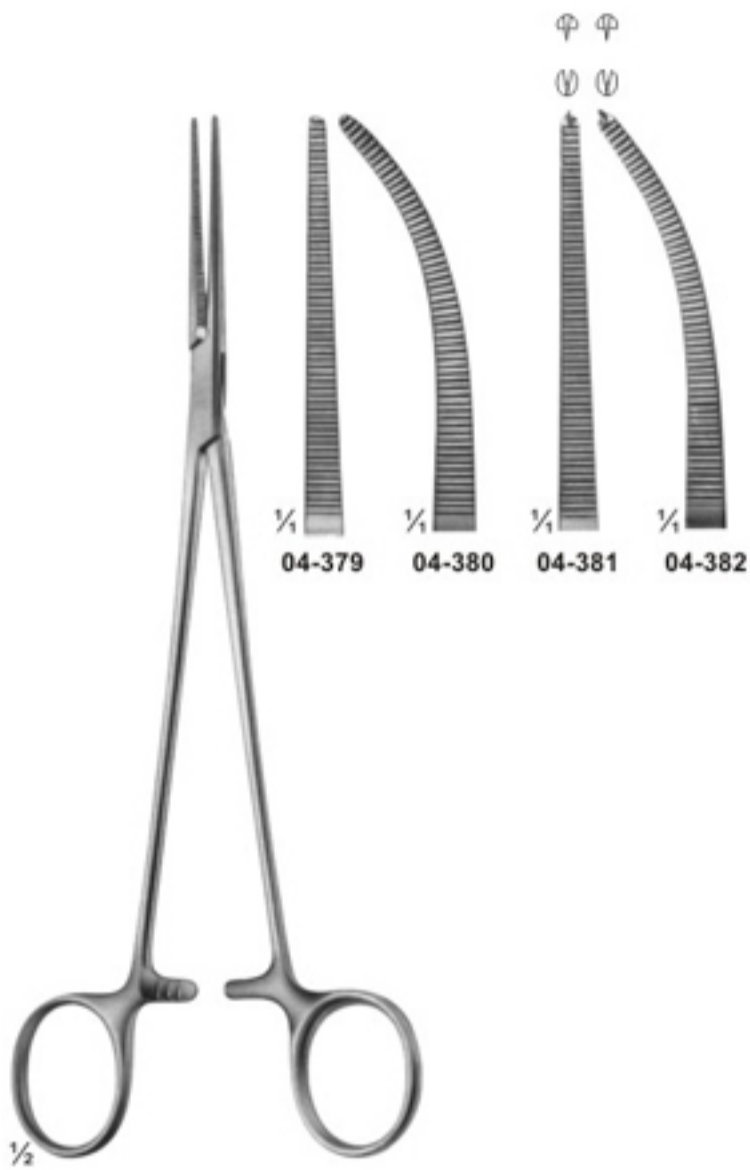

04-379 - 04-382
HALSTED-MOSQUITO
200 mm



04-383 - 04-387
HEISS
200 mm



04-388 - 04-389
HALSTED
215 mm

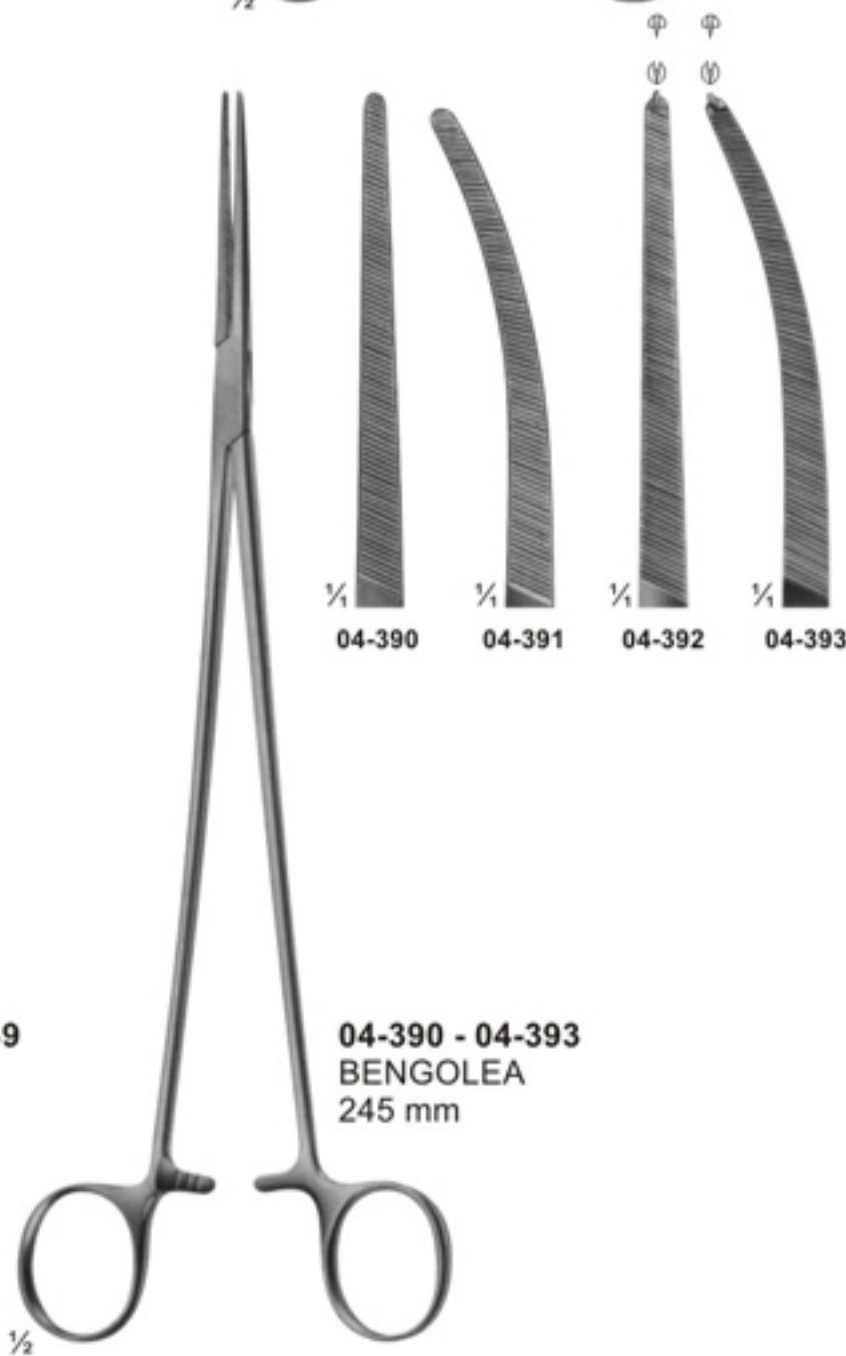

04-390 - 04-393
BENGOLEA
245 mm



04-394
CRAFOORD
245 mm

Delicate Haemostatic Forceps



04-395
CARREL
85 mm



04-396 - 04-399
BABY-MOSQUITO
(HARTMANN)
100 mm

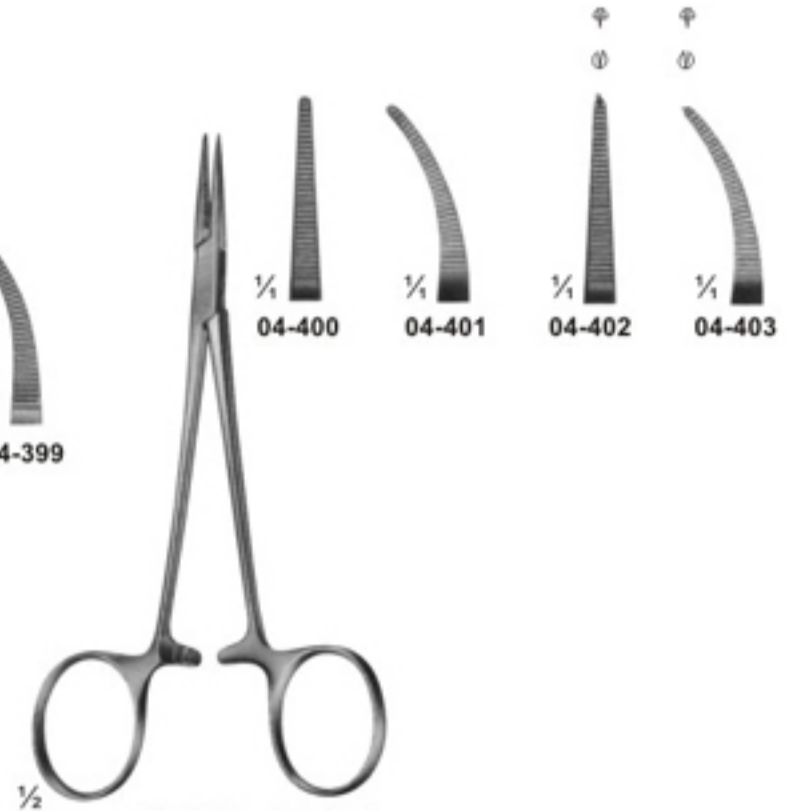

04-400 - 04-403
MICRO-HALSTED
125 mm

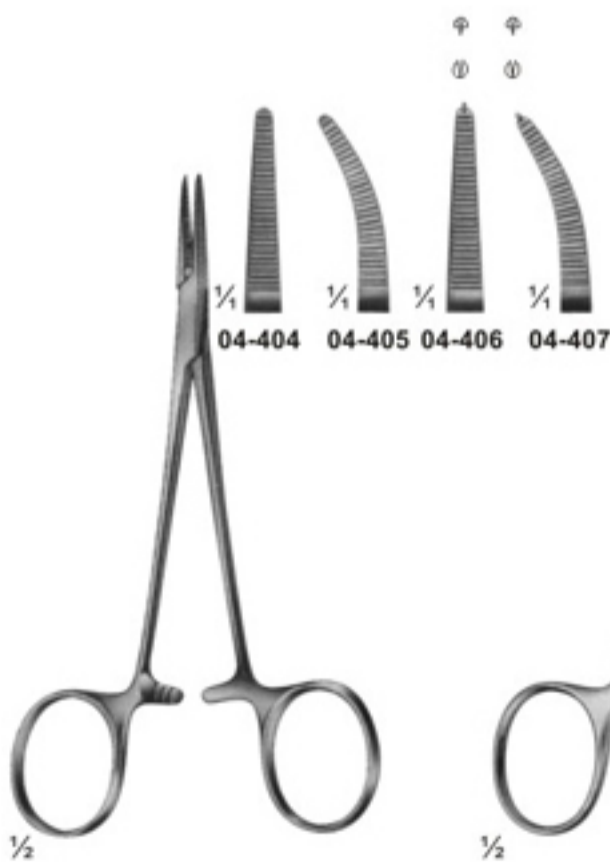

04-404 - 04-407
HALSTED-MOSQUITO
125 mm

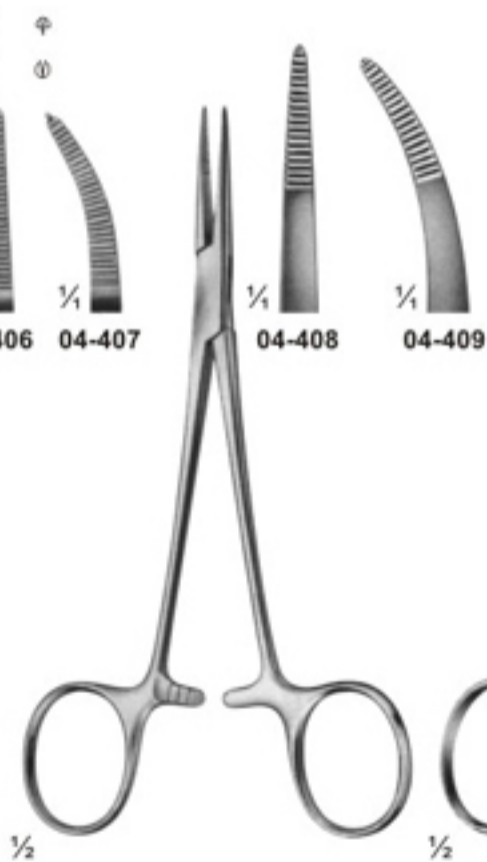

04-408 - 04-409
PROVIDENCE-HOSPITAL
140 mm

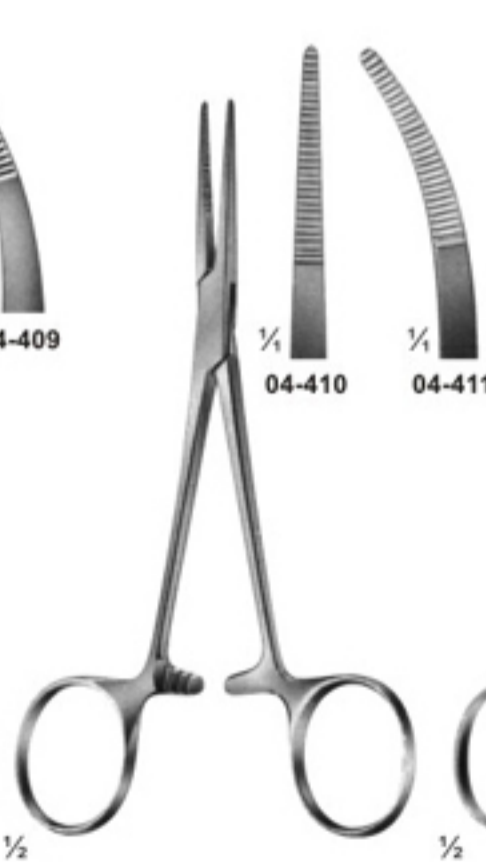

04-410 - 04-411
KELLY
140 mm

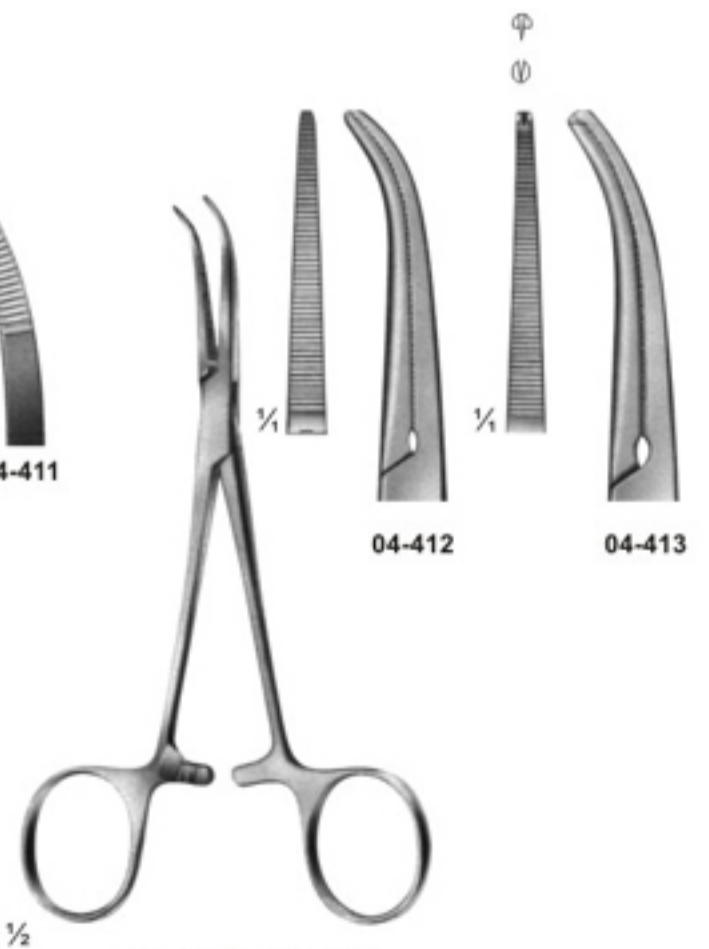

04-412 - 04-413
DANDY
Curved sideways
140 mm

Delicate Haemostatic Forceps

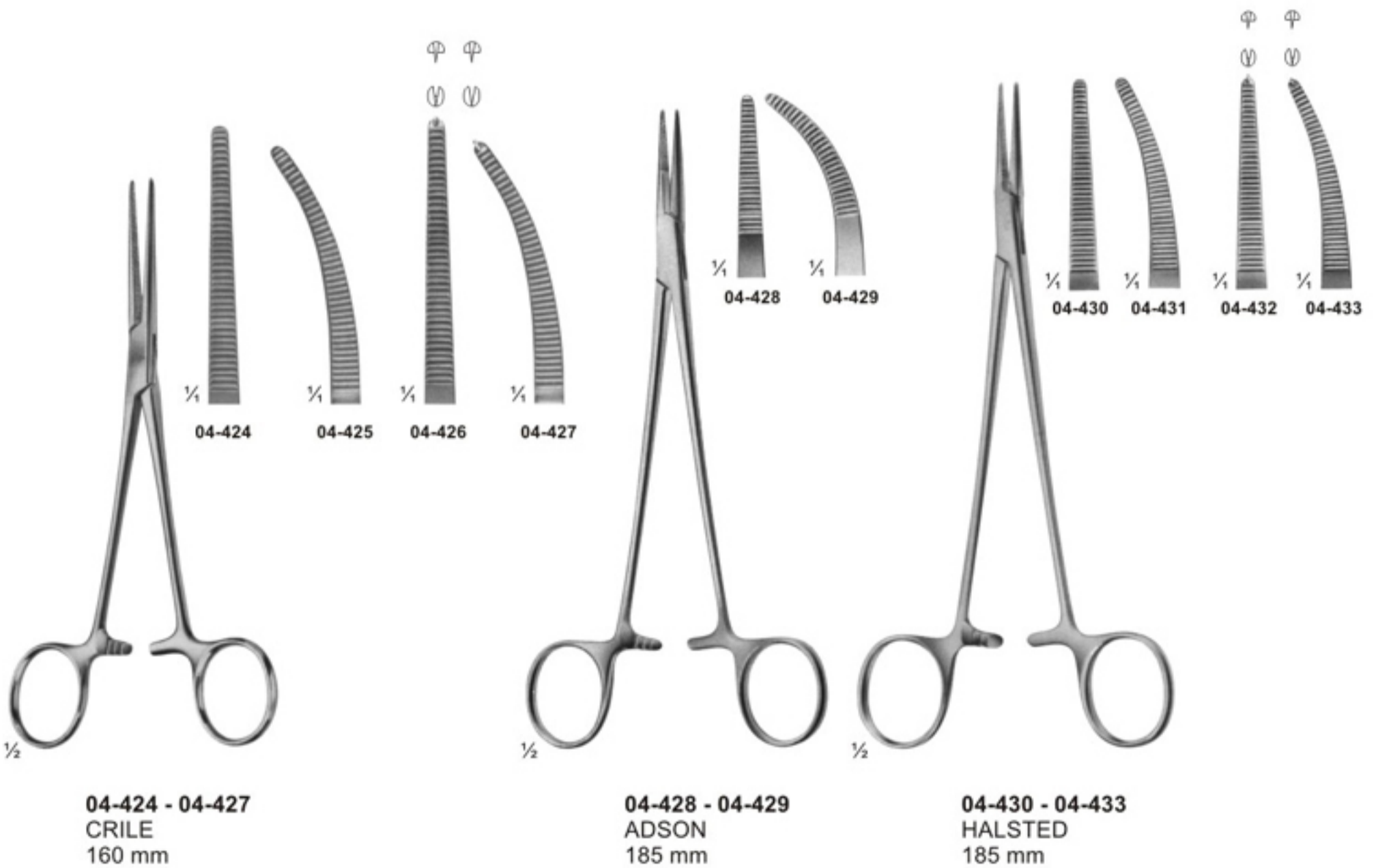
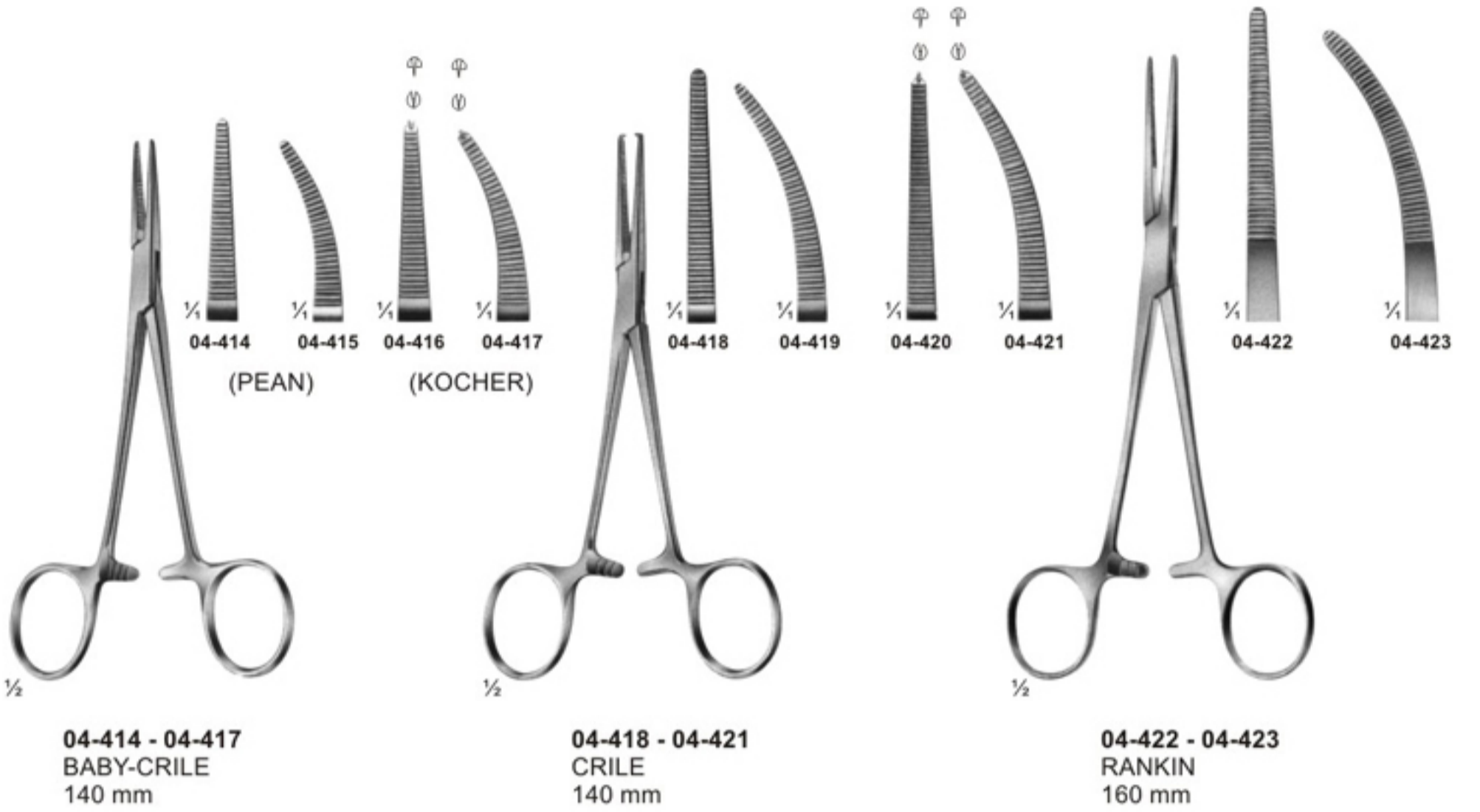

Haemostatic Forceps

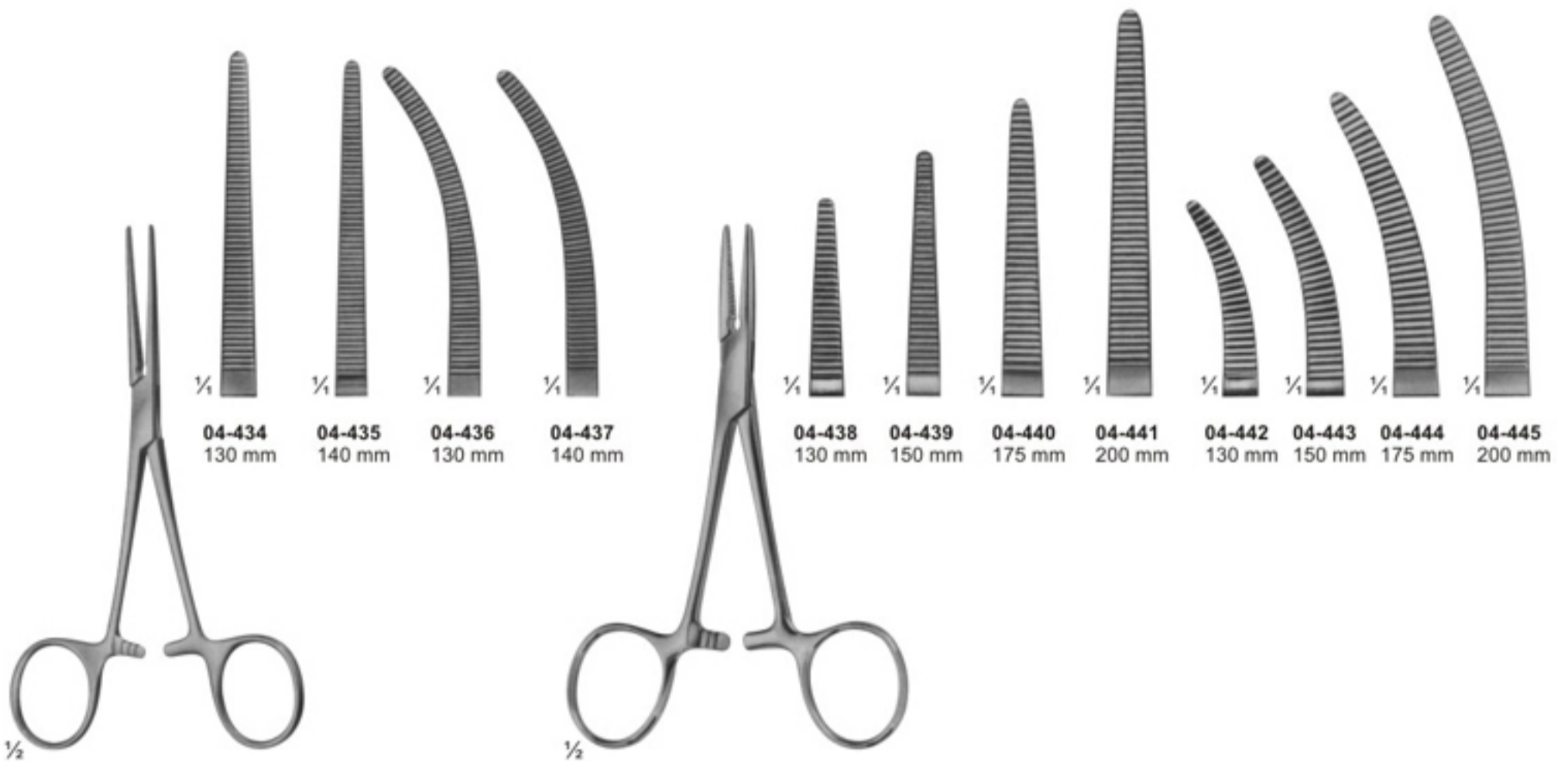

04-434 - 04-437
PEAN
Slender type

04-438 - 04-445
SPENCER-WELLS
Slender type

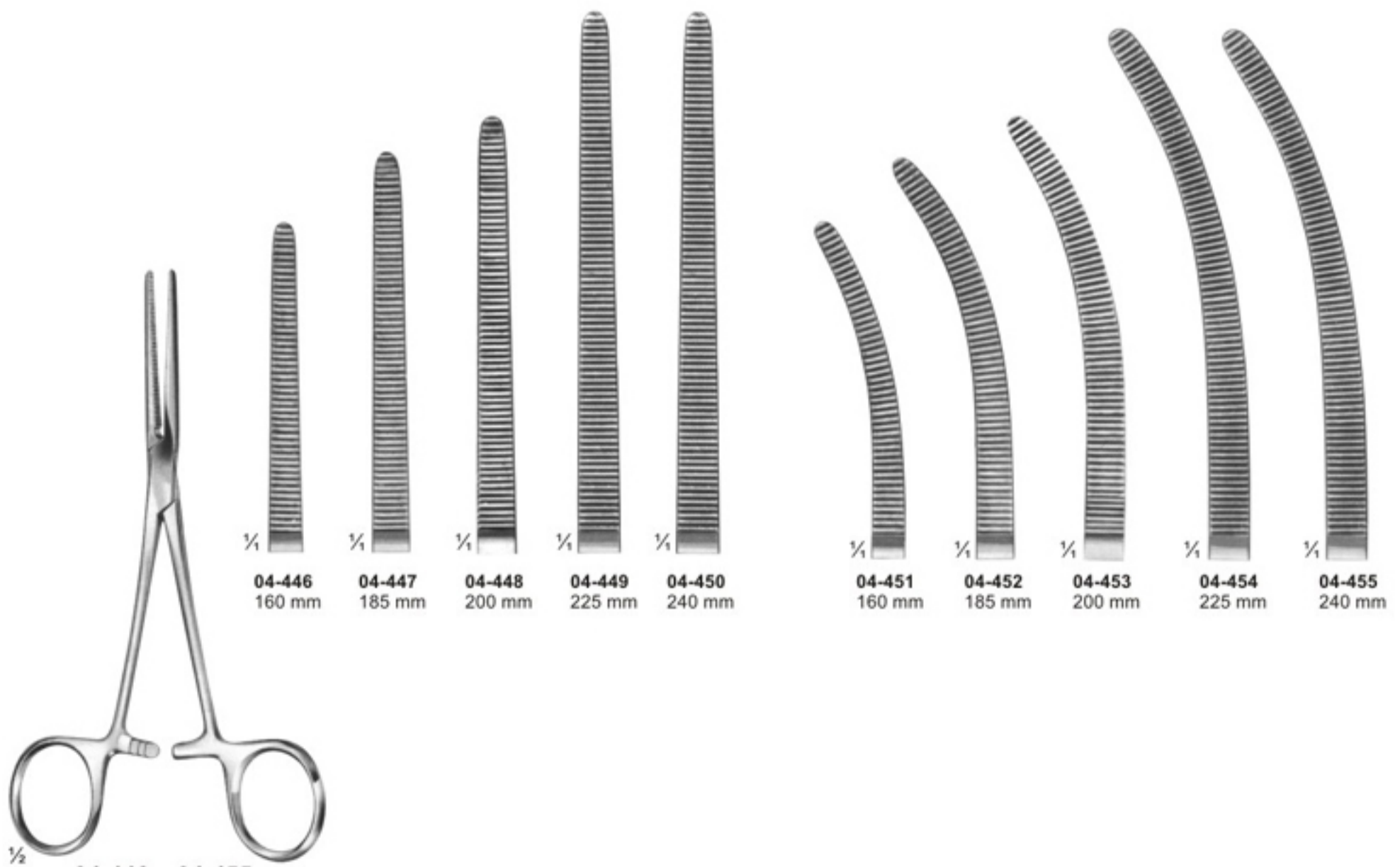

04-446 - 04-455
ROCHESTER-PEAN

Haemostatic Forceps

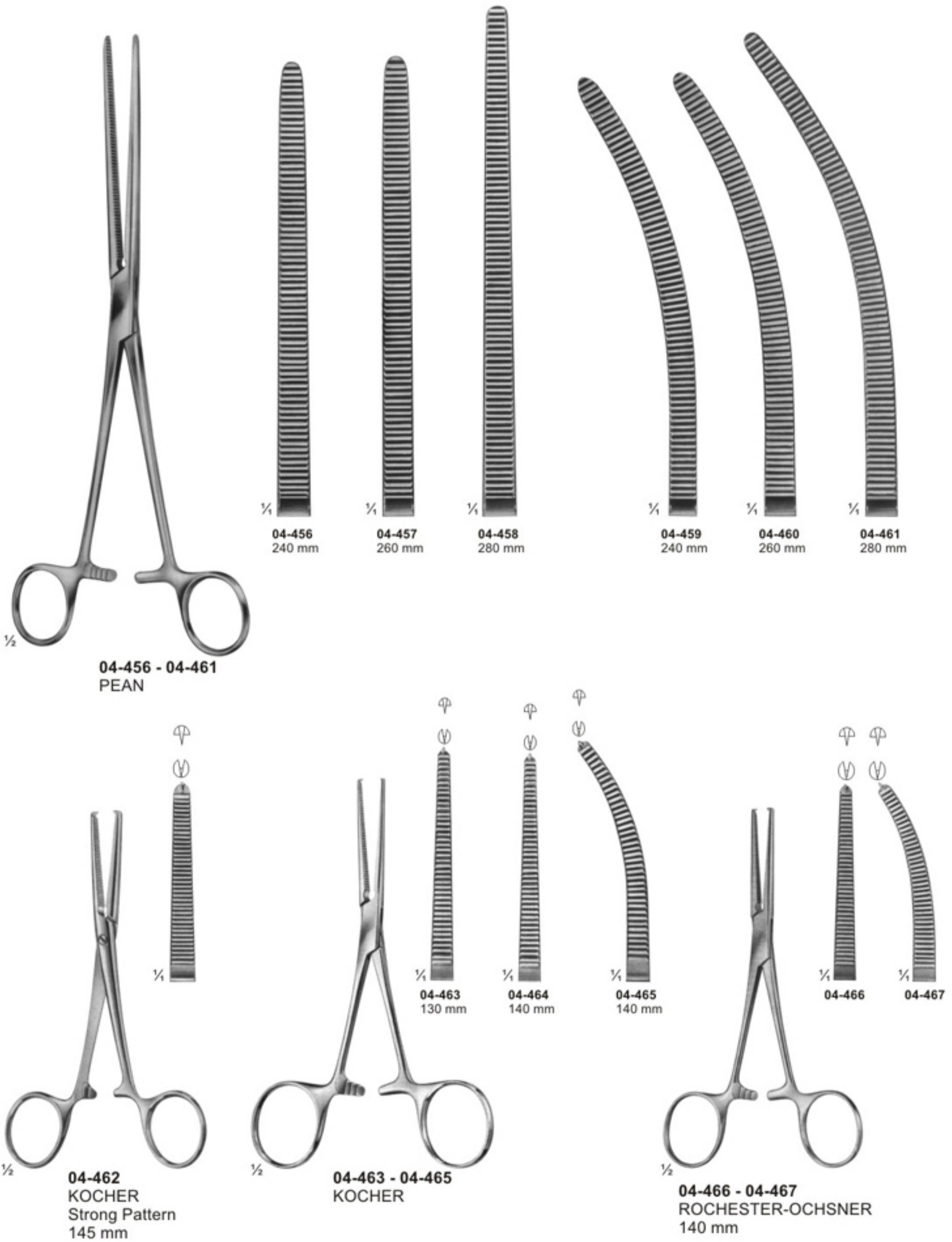

Haemostatic Forceps

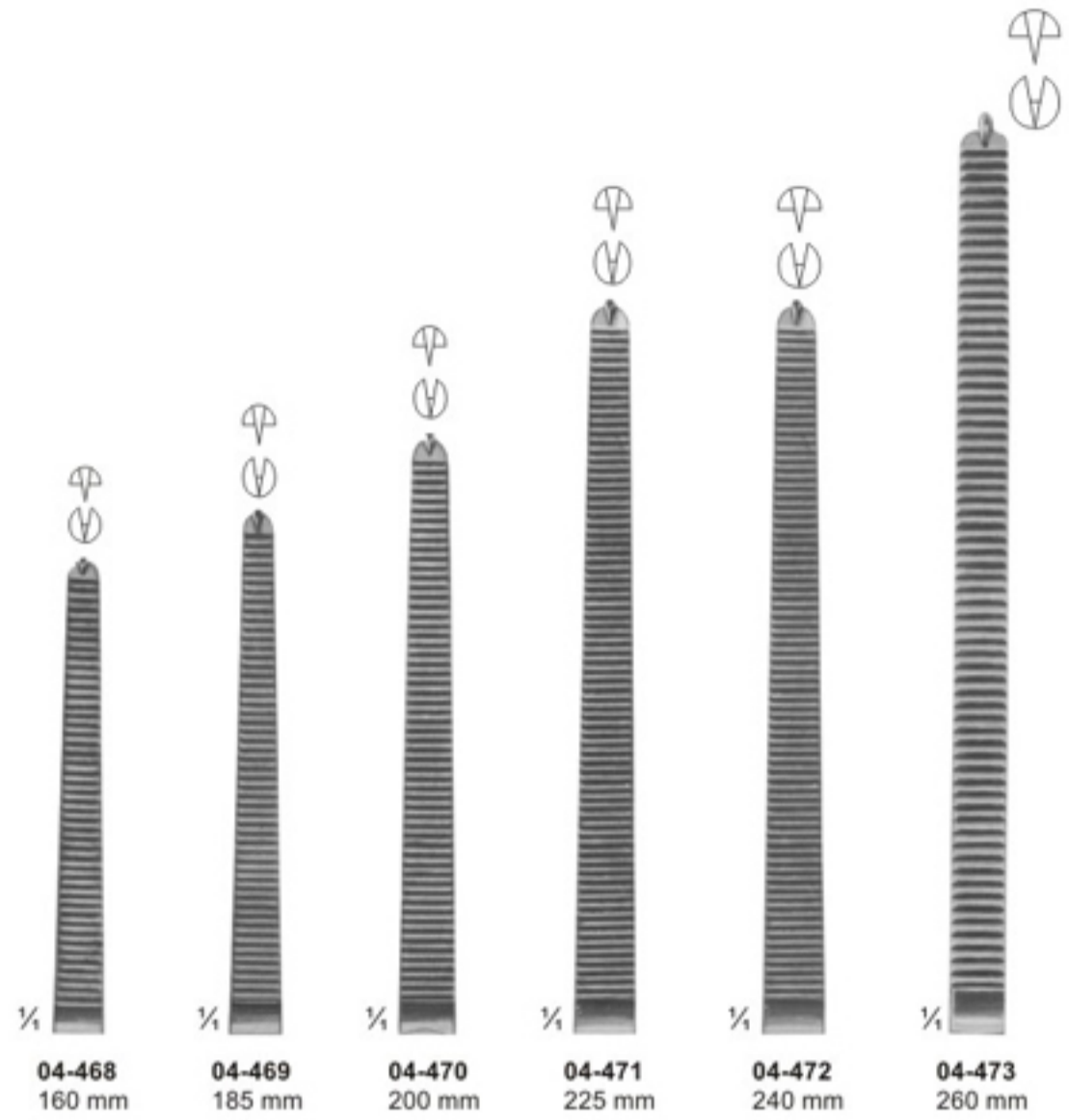

04-468 - 04-479
KOCHER-OCHSNER

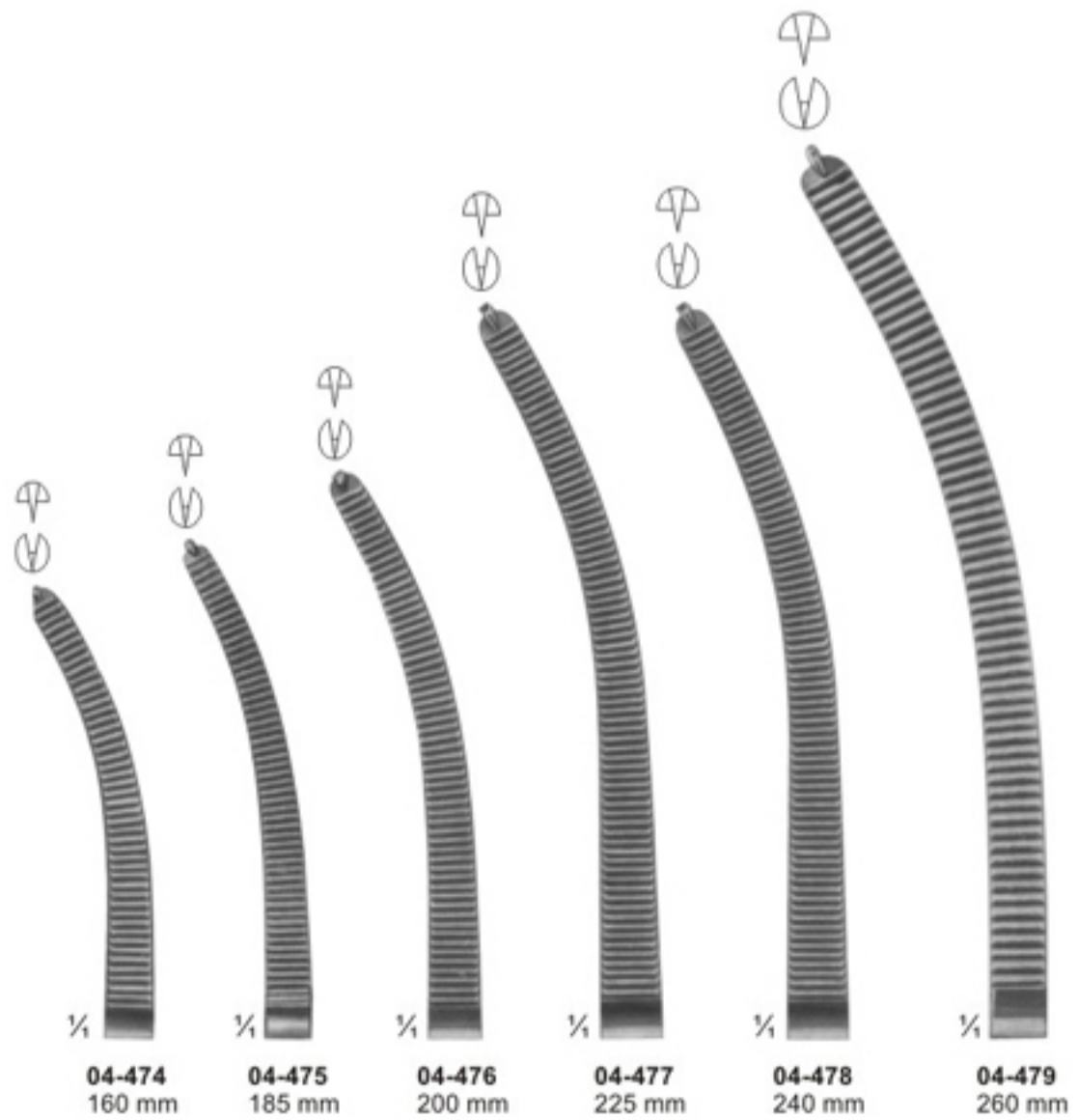

Haemostatic Forceps

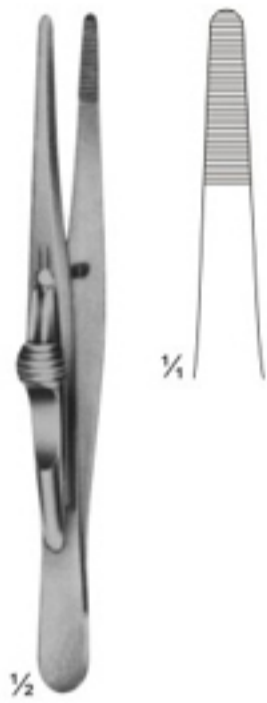

04-480
FRICKE
Artery forceps
130 mm



04-481
KRONLEIN
130 mm

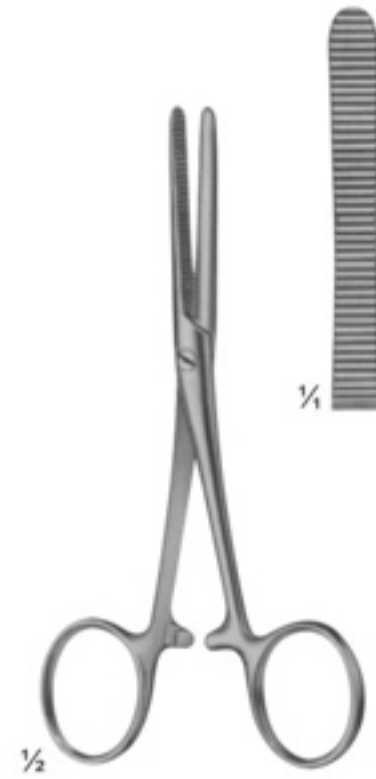

04-482
PEAN
125 mm



04-483
125 mm



04-484
140 mm

04-483 - 04-484
PEAN

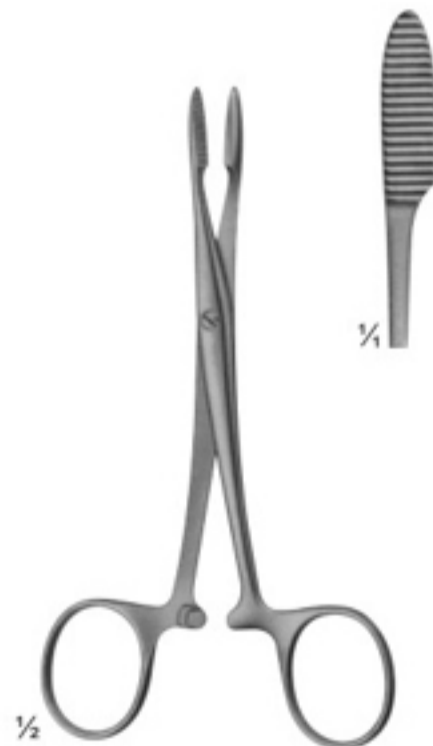

04-485
PEAN
125 mm

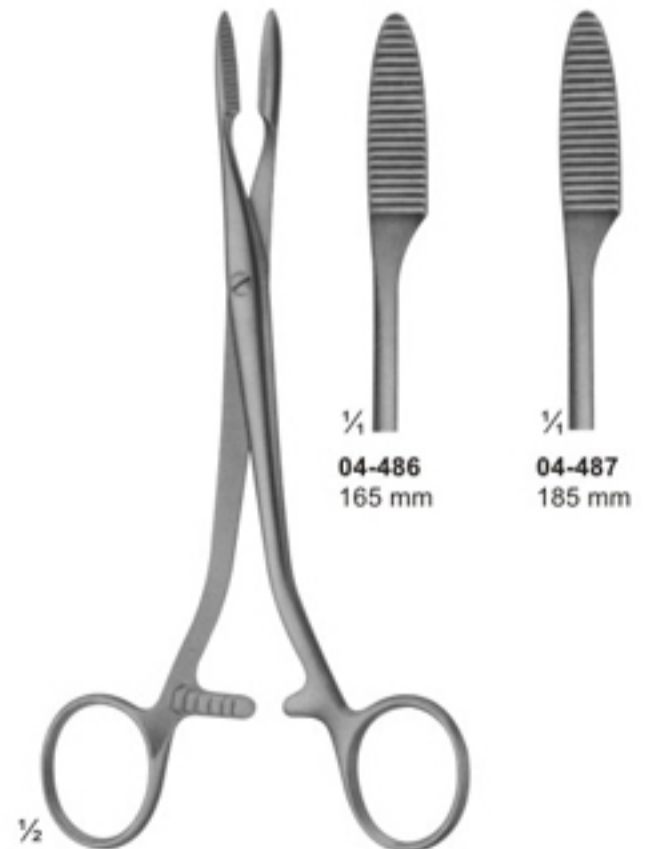

04-486
165 mm

04-487
185 mm

04-486 - 04-487
PEAN

Haemostatic Forceps, Special Pattern, Tonsil Forceps

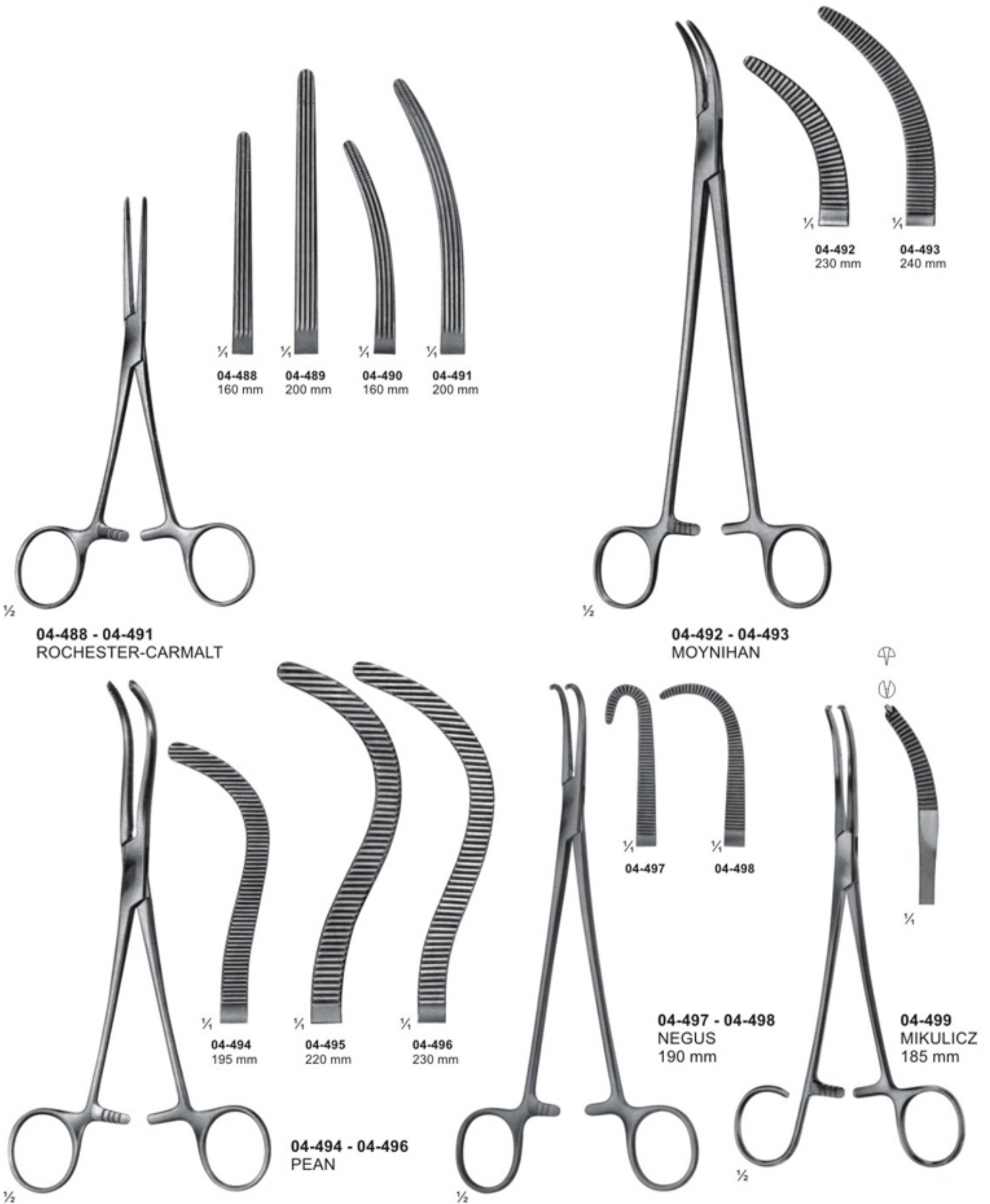

Dissecting- and Ligature Forceps

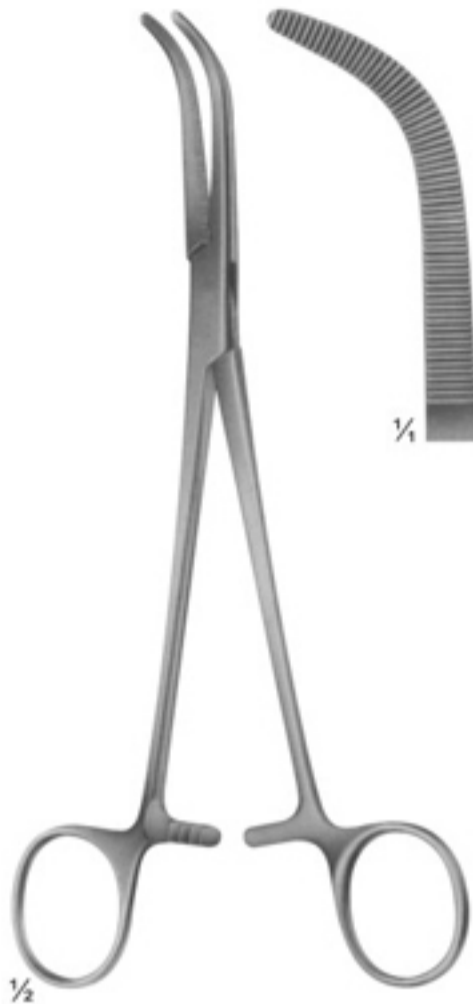

04-500
MIXTER-O'SHAUGNESSY
190 mm

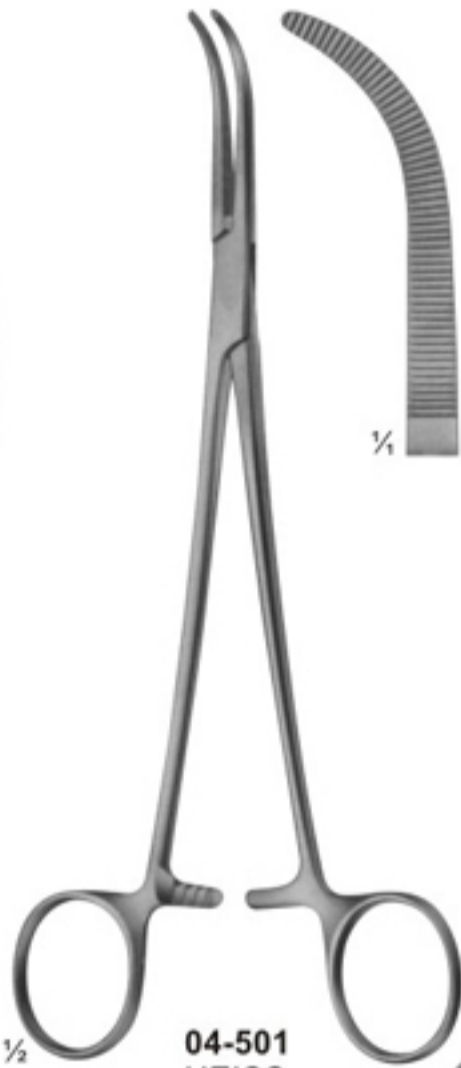

04-501
HEISS
195 mm

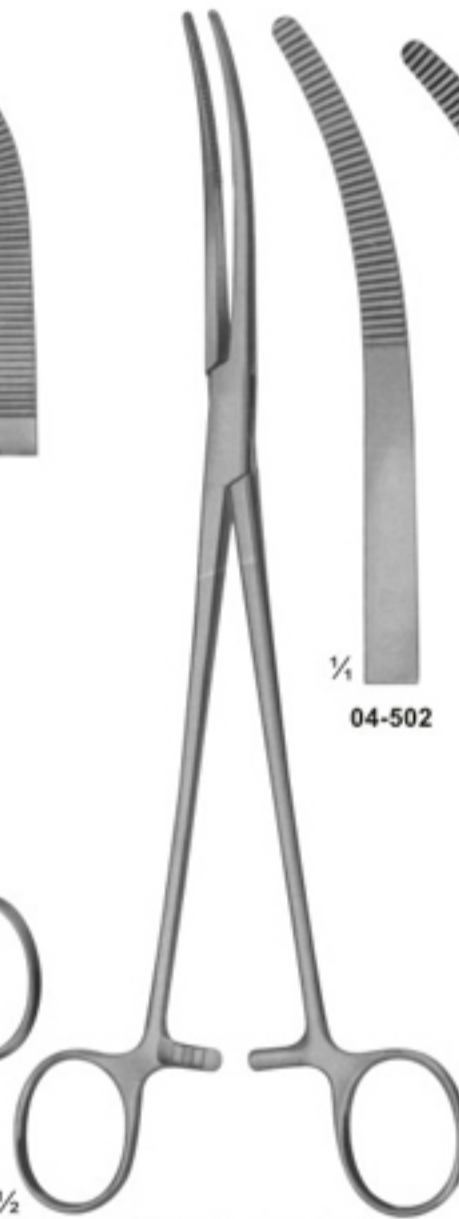

04-502 - 04-506
RUMEL
240 mm

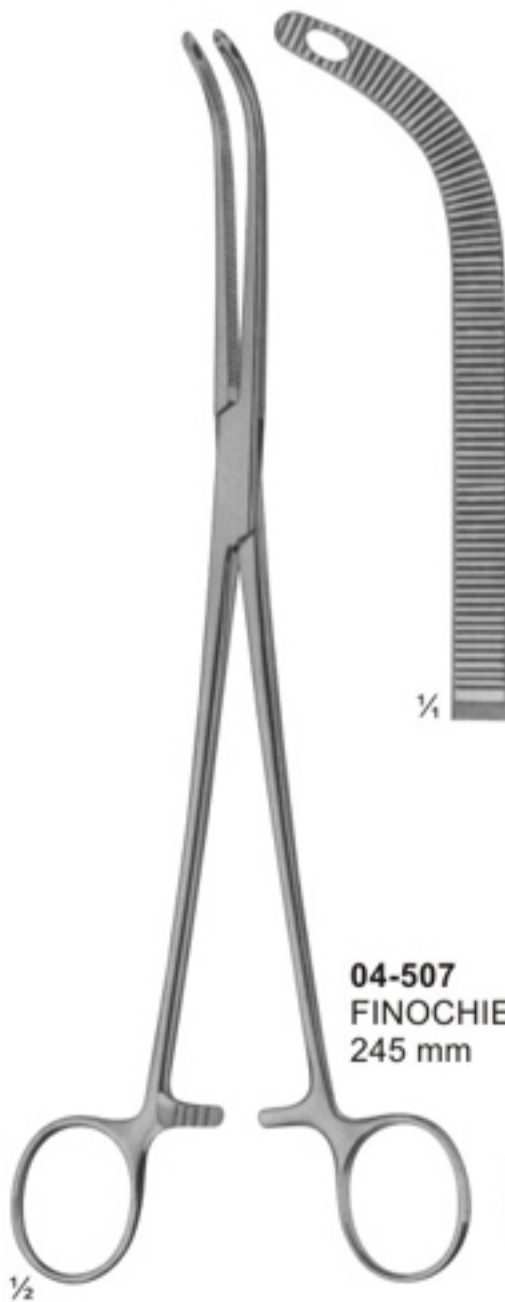

04-507
FINOCHIETTO
245 mm

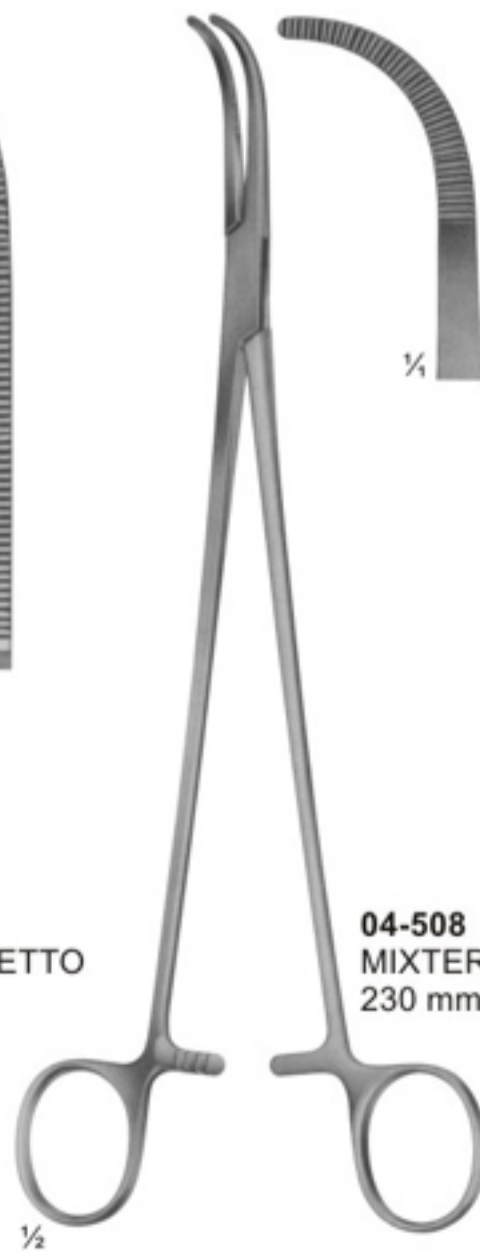

04-508
MIXTER
230 mm



04-509
LAWRENCE
270 mm

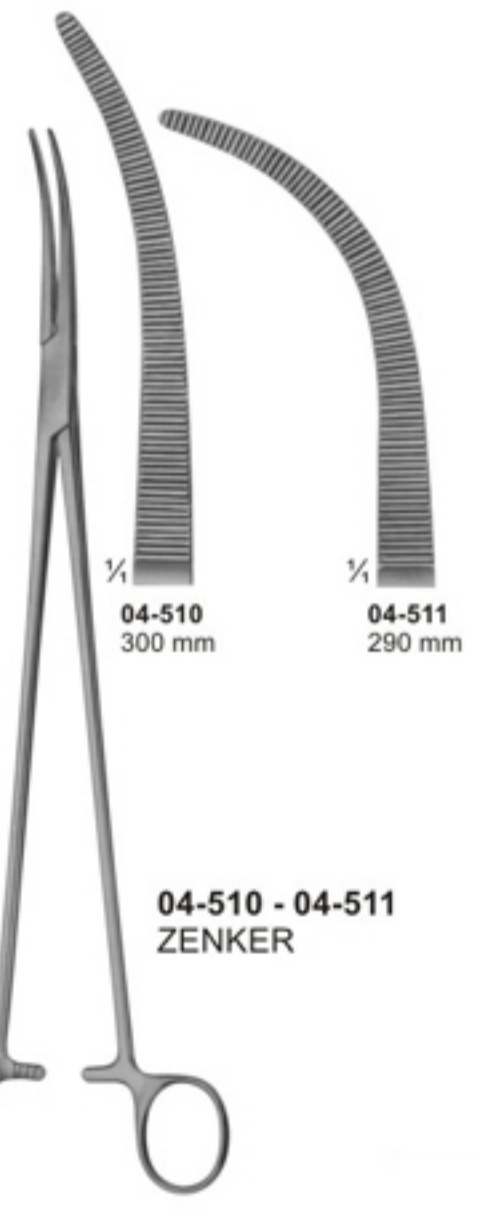

04-510 - 04-511
ZENKER

**Hysterectomy Forceps, Vaginal Clamps
and Compression Forceps**



04-512
WERTHEIM
Hysterectomy forceps
255 mm

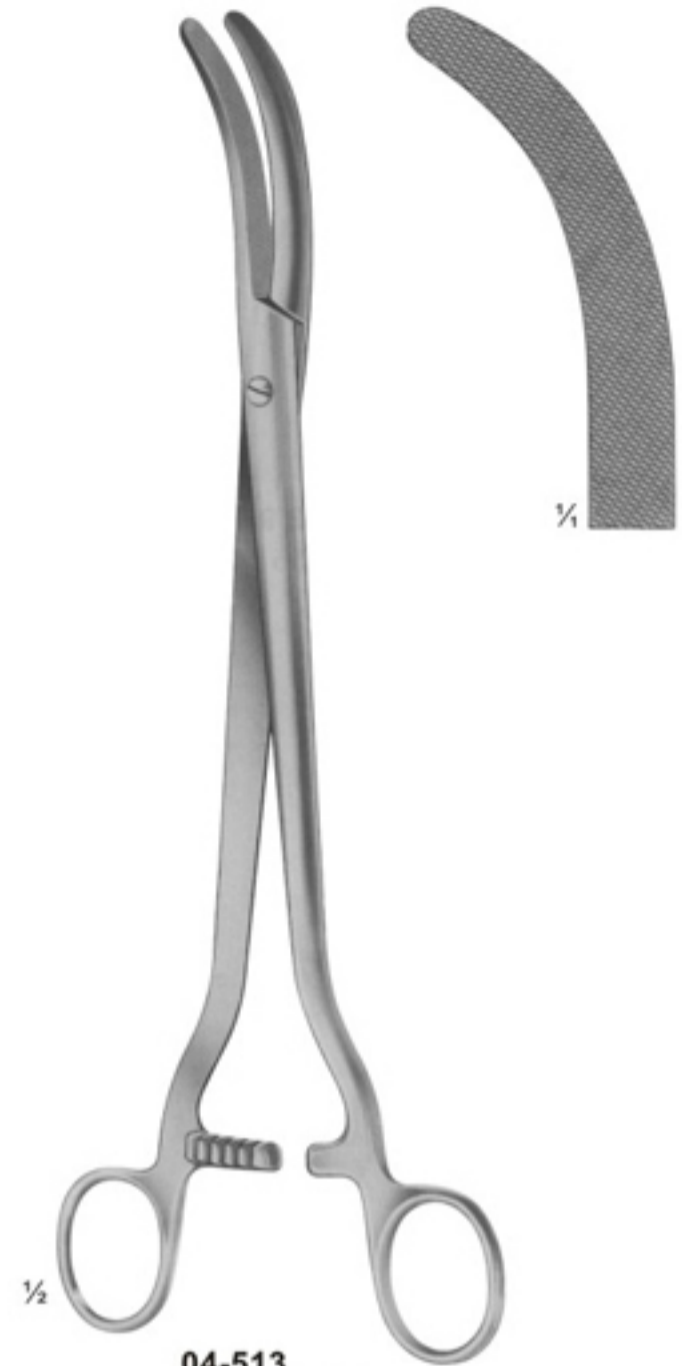

04-513
WERTHEIM
Parametrium clamp
260 mm

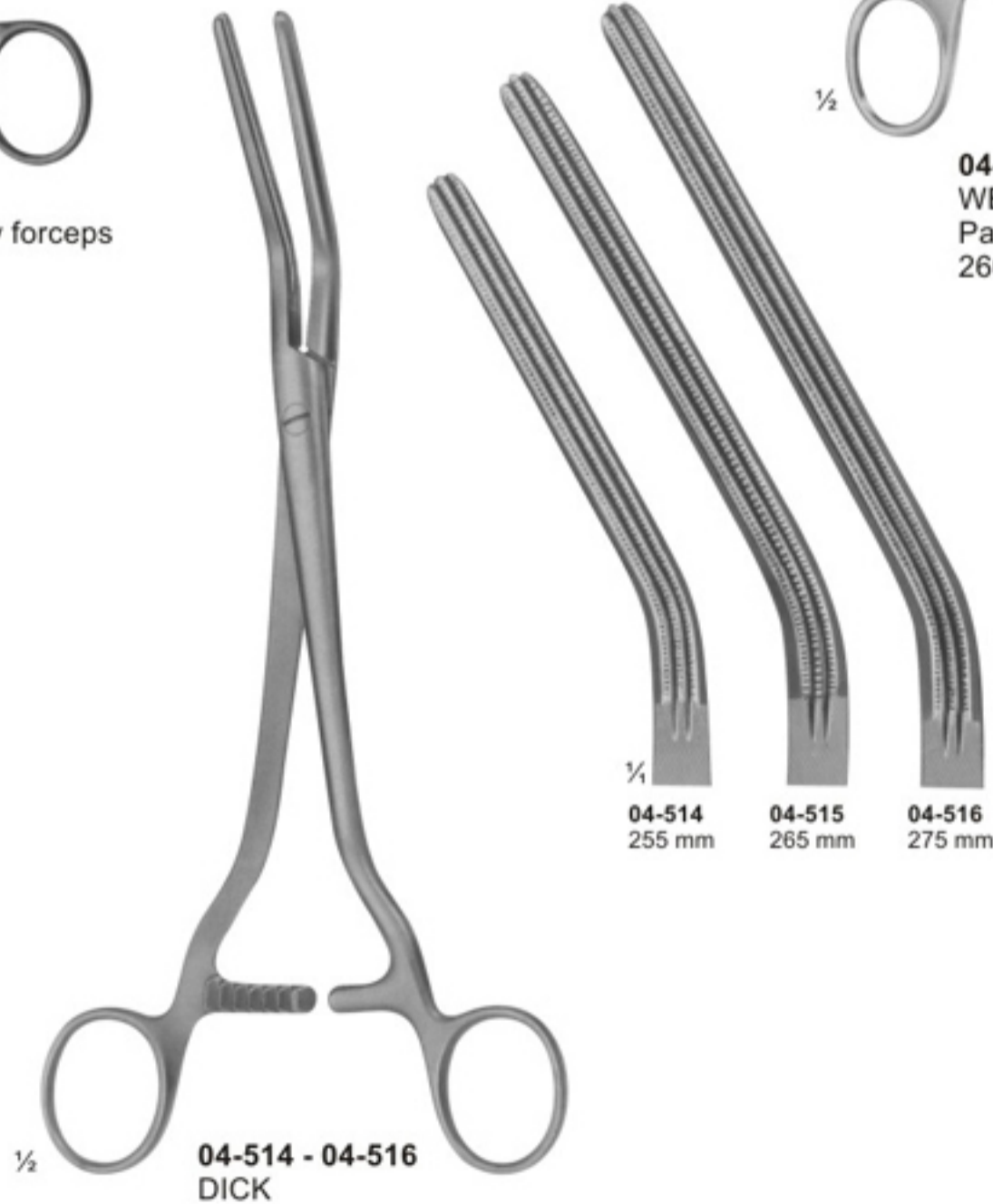

04-514 255 mm
04-515 265 mm
04-516 275 mm

04-514 - 04-516
DICK

**Hysterectomy Forceps, Vaginal Clamps
and Compression Forceps**

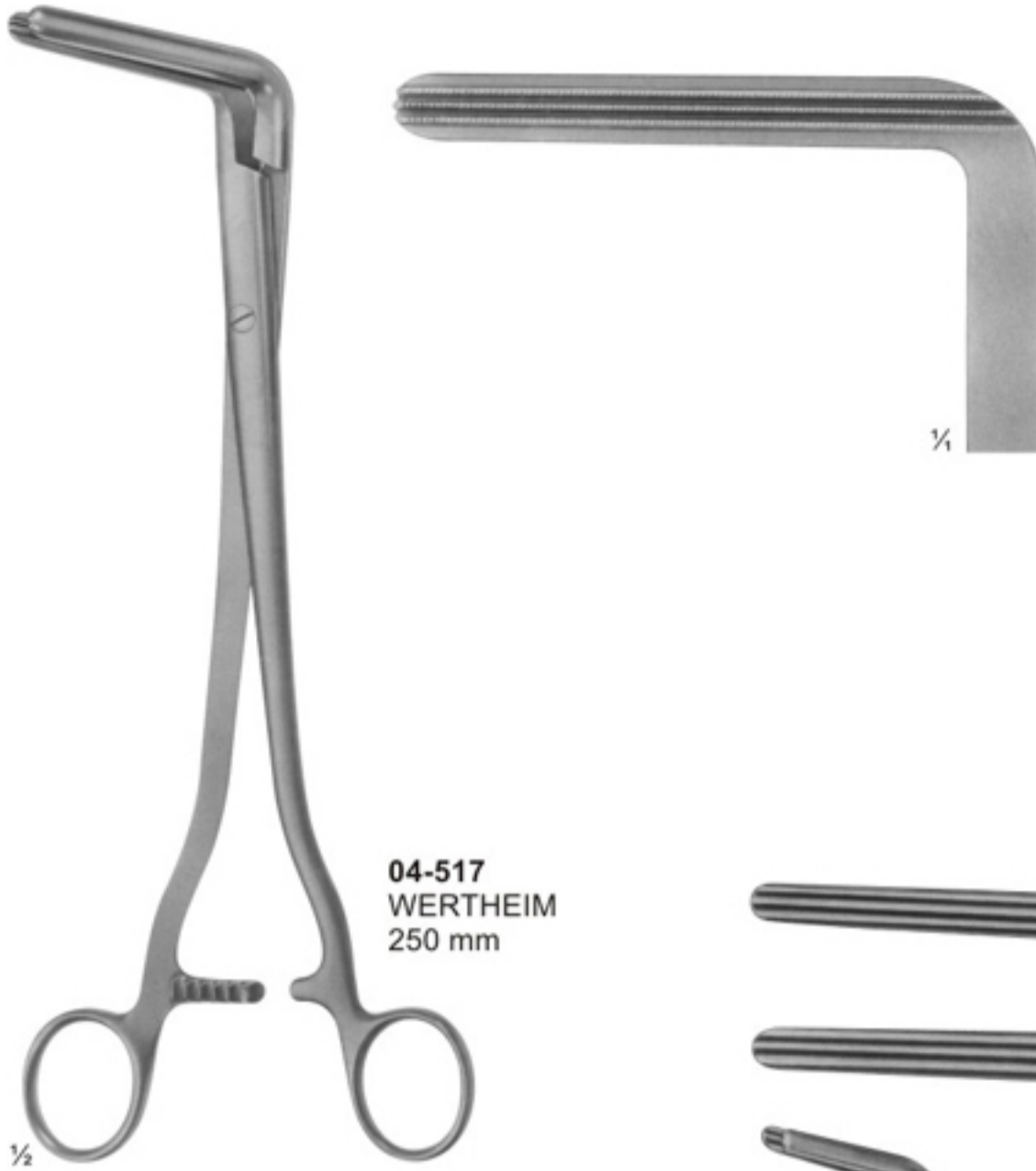

04-517
WERTHEIM
250 mm

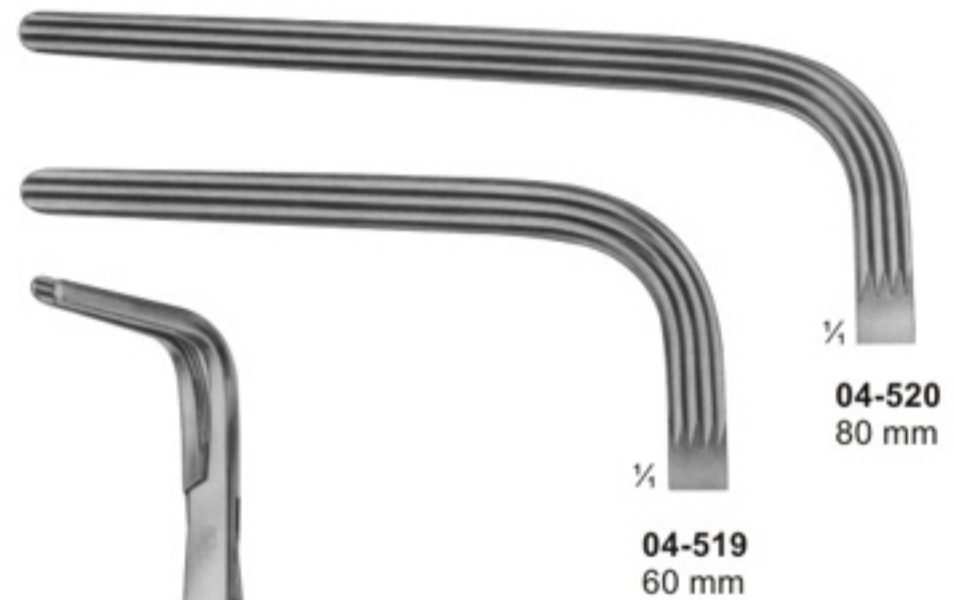

04-519
60 mm

04-520
80 mm



04-518
WERTHEIM-CULLEN
215 mm



04-519 - 04-520
230 mm

Needle Holders for micro surgery



05-101
ROHRSCHEIDER
with copper inserts
100 mm



05-102
KALT
with catch
135 mm



05-103
ARRUGA
with catch
135 mm



05-104 - 105
CASTROVIEJO
with catch
145 mm



05-106 - 107
without Catch
160 mm



05-108 - 109
without catch
185 mm



05-110 - 111
JACOBSON
185 mm



05-112
without catch
195 mm



05-113 - 114
YASARGIL
with catch
200 mm

Needle Holders



Needle Holders

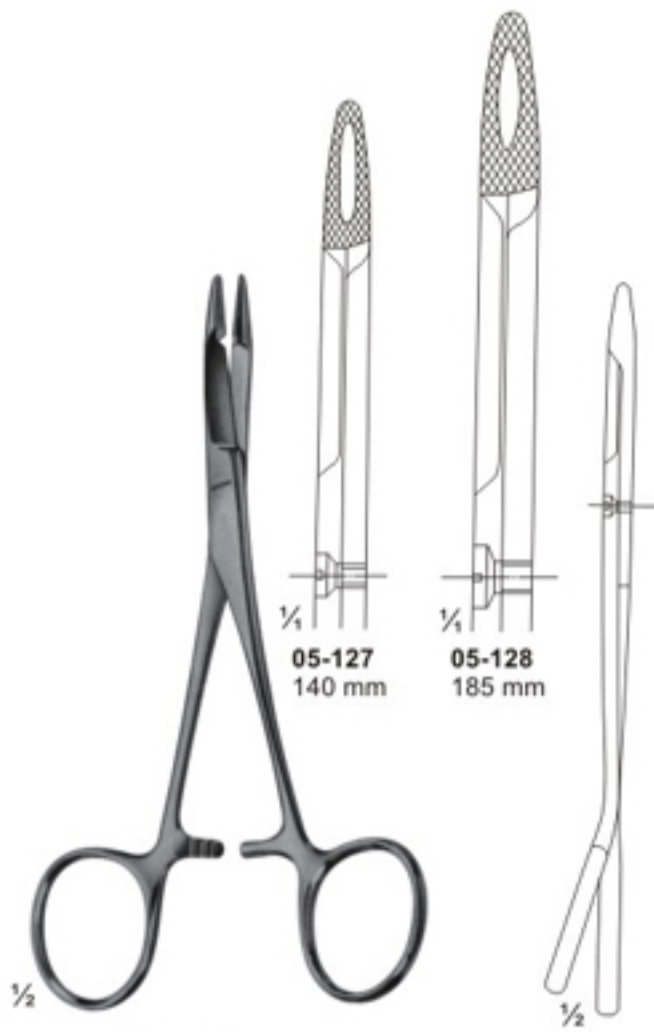

05-127 - 128
HEGAR-OLSEN
255 mm

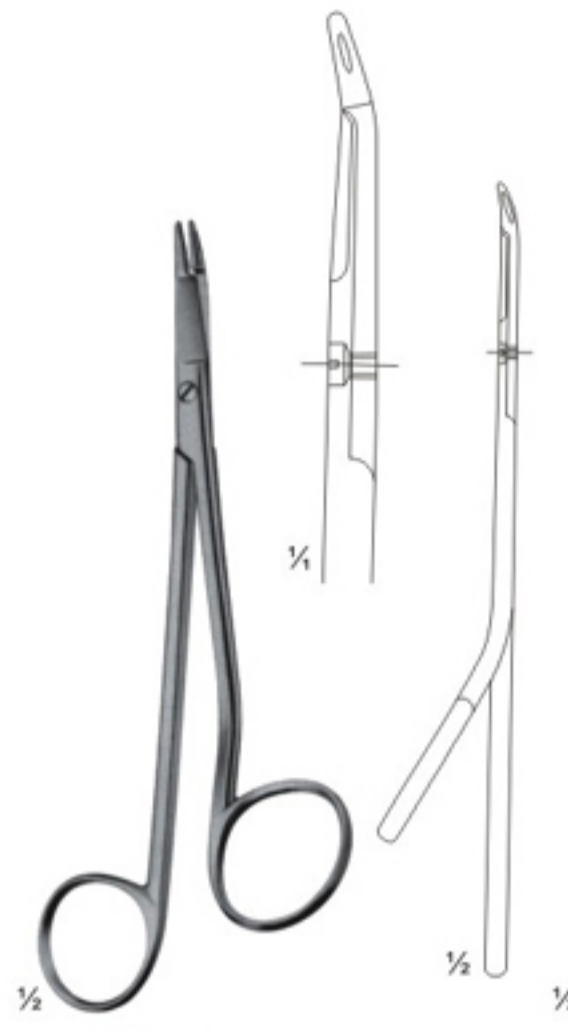

05-129
GILLIES
150 mm



05-130
GILLIES
160 mm

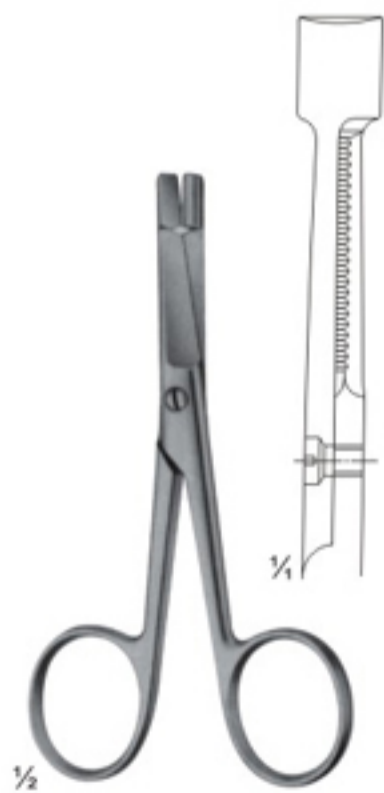

05-131
EISELSBERG
115 mm

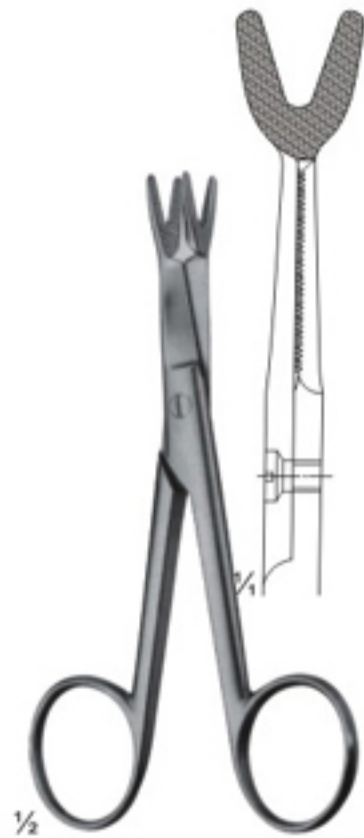

05-132
SCHOEMAKER-LOTH
125 mm



05-133
CRILE
150 mm



05-134
TOENNIS
Elastic pattern for dura-or
intestinal suture. 180 mm

Needle Holders

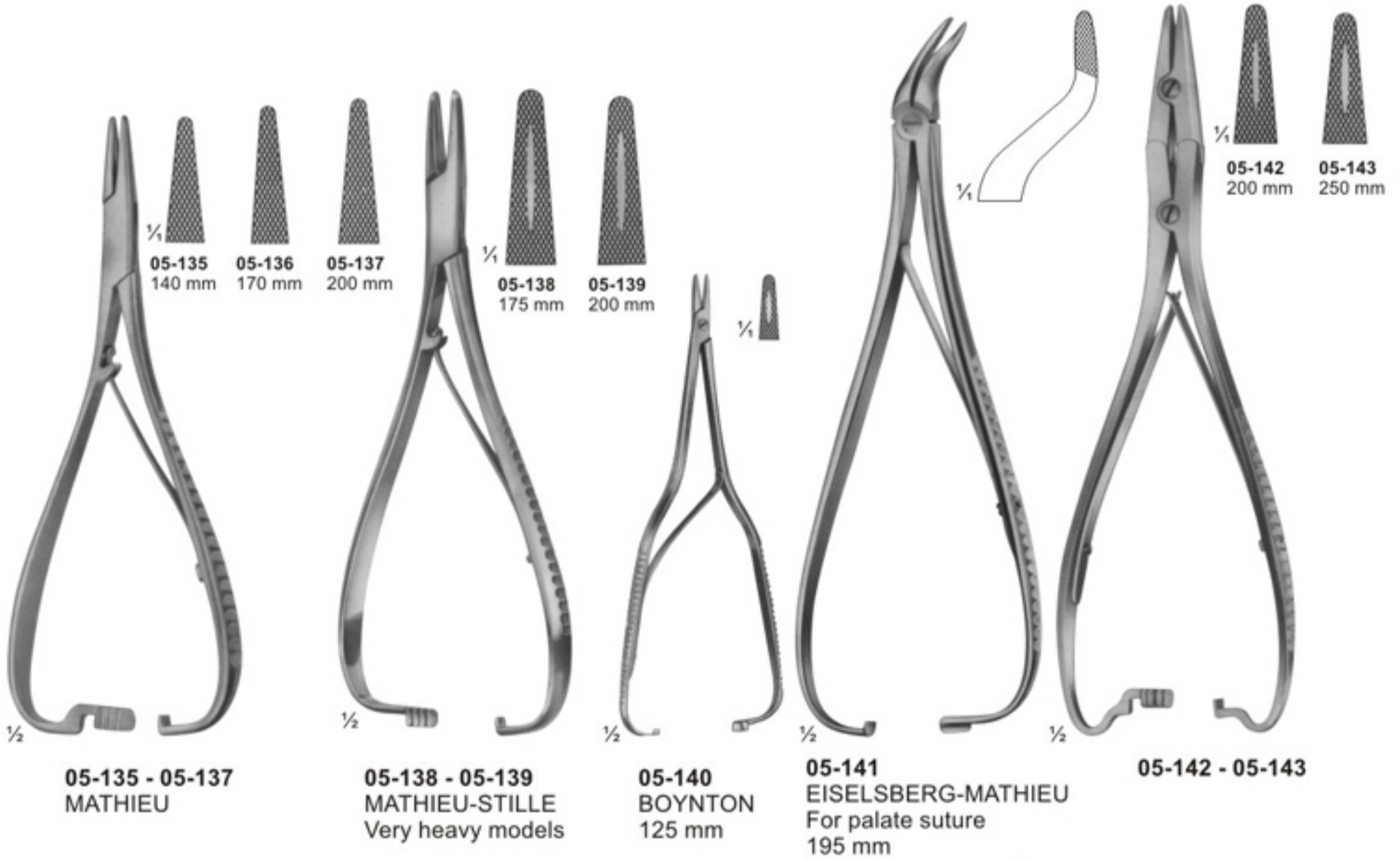

Suture Instruments - Reverdin Needles

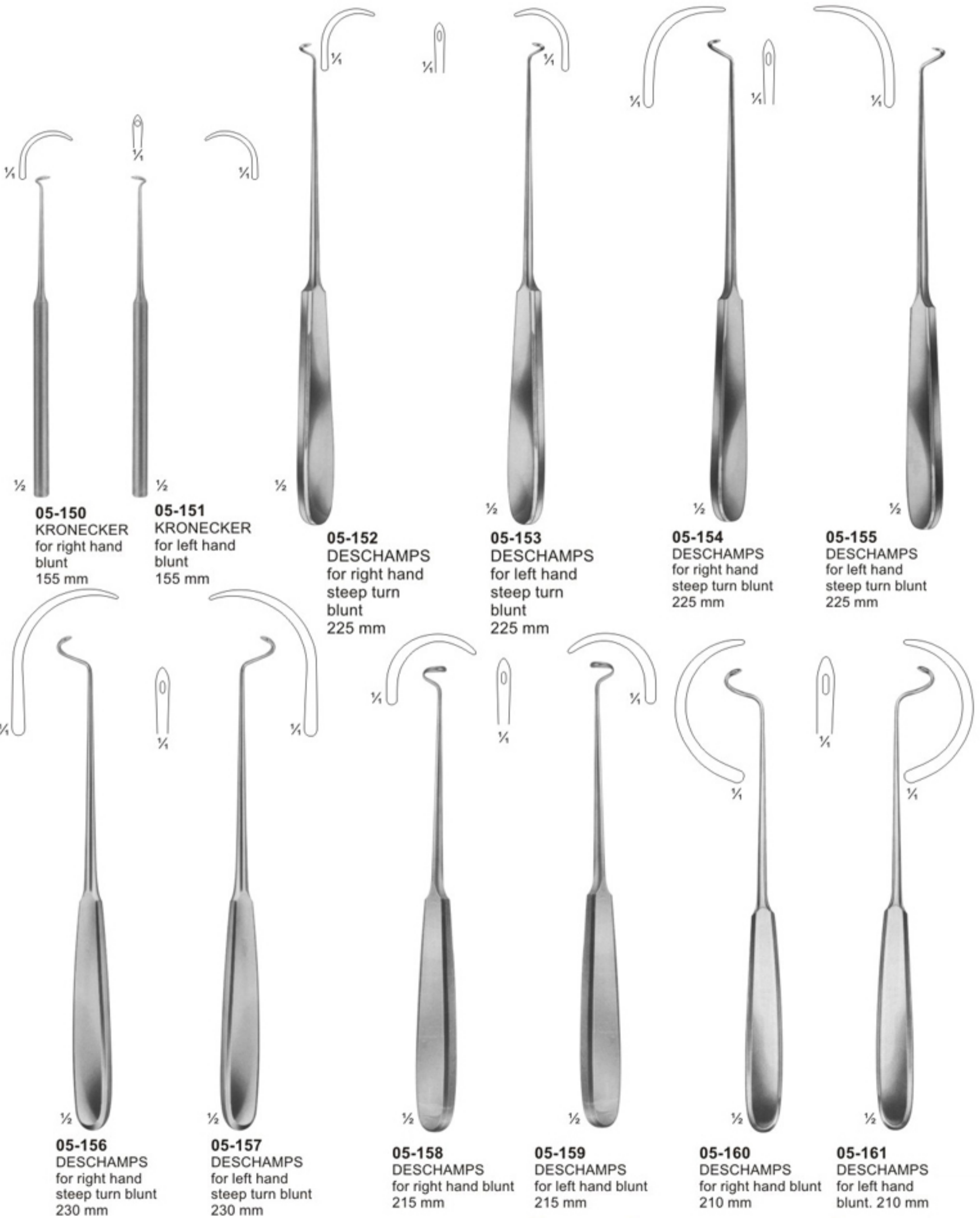

Probes



05-162 130 mm
05-163 145 mm
05-164 160 mm
 Directors

05-165
DOYEN
 145 mm
 Directors

05-166
NELATON
 160 mm
 Directors

05-167
 Director with tip
 Diam. Of tip 3,3 mm
 140 mm

05-168
BRODIE
 Director with tip,
 Diam. Of tip 3,5 mm
 200 mm

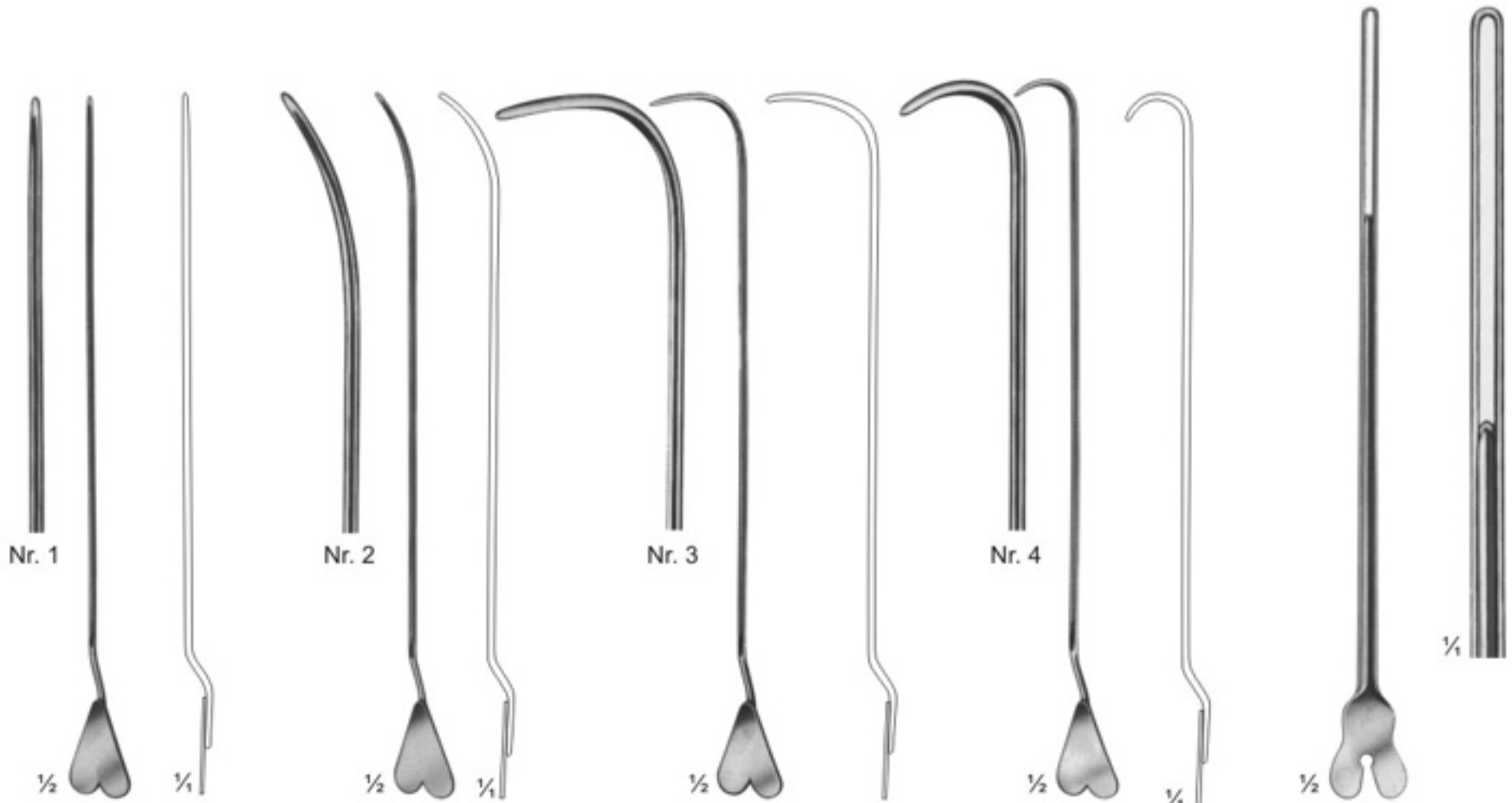

05-169
LOCKHART-MUMMERY
 165 mm

05-170
LOCKHART-MUMMERY
 165 mm

05-171
LOCKHART-MUMMERY
 165 mm

05-172
LOCKHART-MUMMERY
 165 mm

05-173
 Director with wire
 loop, malleable
 190 mm

Probes



05-174
2,5 mm
05-175
2,5 mm
05-176
3,0 mm

05-174 145 mm
05-175 160 mm
05-176 200 mm
Probes with eye



1,5 mm

05-177
Myrtle leaf probe
145 mm



2,0 mm

05-178 130 mm
05-179 145 mm
05-180 160 mm
05-181 180 mm
05-182 200 mm



05-183
Probes



05-184 1/2
Double ended probe,
malleable, diam. of tips
3 mm with hole
190 mm



05-185
Double ended probes,
tin, malleable,
diam. of tips
3,5 mm with hole
250 mm 300 mm



05-186 1/4
Double ended probes,
tin, malleable,
diam. of tips 4 mm
400 mm



1/2 \varnothing tip
05-187 1,5 mm
05-188 2,0 mm
05-189 2,5 mm
300 mm

Suturing Instrument Set, Pocket Instrument Set



05-190

Suturing instruments set, in metal case consisting of: Scissors, curved, sharp/sharp, 115mm
25 MICHEL clip, 16 x 3mm
1 Delicate tissue forceps, 130mm
1 Scalpel, bellied
1 MATHIEU needle holder, 140mm
1 Perforated metal case, stainless containing:
1 Suture needle
1 item 1 item



05-191

Pocket instrument set, in metal case consisting of:

Bottom tray

1 MATHIEU needle holder, 140mm
1 MICHEL clip forceps, combined
1 Myrtle leaf probe, 130mm
1 Sharp double curette
1 Skin hook
1 Detachable scalpel handle, no.4
1 Perforated metal case, containing
6 Scalpel blades
1 Perforated metal case, stainless, containing
1 Suture needle
1 item
1 item



Top tray

1 Tissue forceps, 130mm
1 KOCHER haemostatic forceps, 130mm
1 Straight surgical scissors, 130mm
1 Dissecting forceps, 130mm
1 FEILCHENFELD splinter forceps, 115mm
25 MICHEL clip, 16 x 3mm
1 Flacon of suture skin, sterile in alcohol



05-192

Pocket instrument set, in metal case consisting of:

Bottom tray

1 MAYO-HEGER needle holder, 150mm
1 MICHEL clip forceps, combined
1 Myrtle leaf probe, 130mm
1 Sharp double curette
1 Skin hook
1 Detachable scalpel handle, no. 4
1 Perforated metal case, consisting
6 Scalpel blades
1 Perforated metal case, stainless, consisting:
1 Suture needle
1 item, & 1 item



Top tray

1 Tissue forceps, 130mm
1 CRILE haemostatic forceps, 140mm
1 Straight surgical scissors, 130mm
1 Dissecting forceps, 130mm
1 FEILCHENFELD splinter forceps, 115mm
25 MICHEL clip, 16 x 3mm
1 Flacon of suture silk, sterile in alcohol

Fine Wound Retractors (Dura- and Skin Retractors)

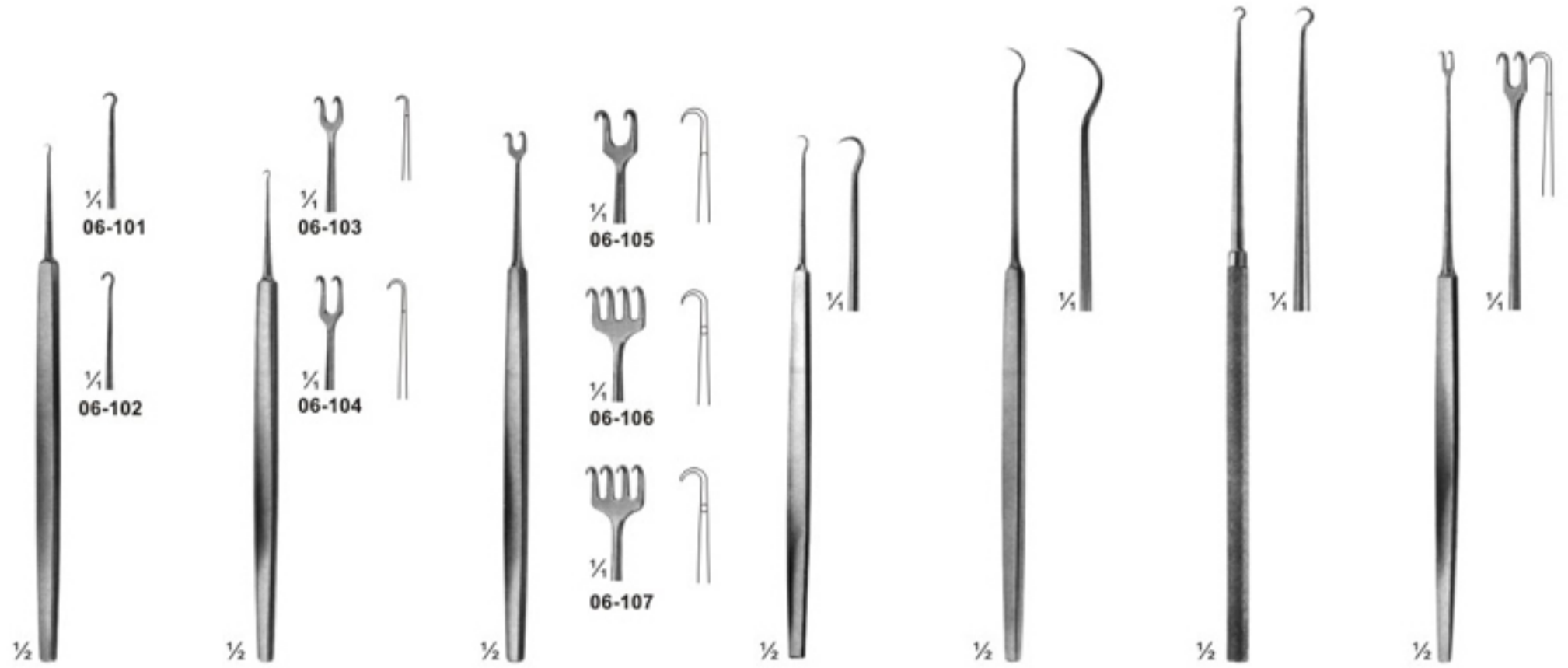

06-101 Sharp
06-102 Blunt
GRAEFE
125 mm

06-103 125 mm
06-104 130 mm
sharp
GUTHRIE

06-105 130 mm
06-106 135 mm
sharp
ROLLET
06-107 135 mm
blunt

06-108
FRAZIER
Dura retractors
130 mm

06-109
TONNIS
Dura retractors
150 mm

06-110
KILNER
160 mm

06-111
FREER
150 mm

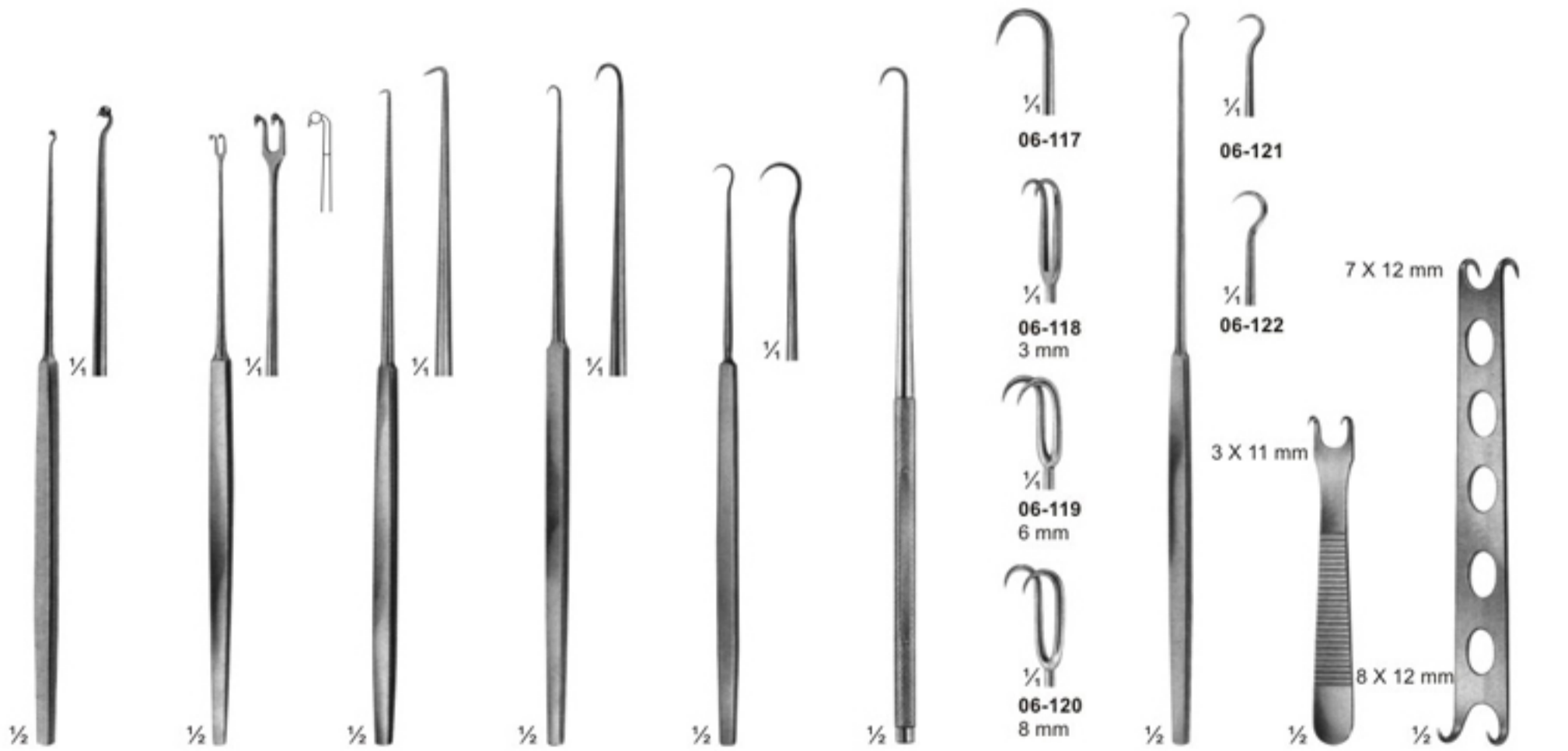

06-112
MULLER
150 mm

06-113
MULLER
150 mm

06-114
COTTLE
160 mm

06-115
COTTLE
160 mm

06-116
JAEGER
135 mm

06-117 - 120
JOSEPH
165 mm

06-121 - 122
GILLIES
180 mm

06-123
KILNER
sharp
80 mm

06-124
CONVERSE
blunt
120 mm

Retractors With treangle handle

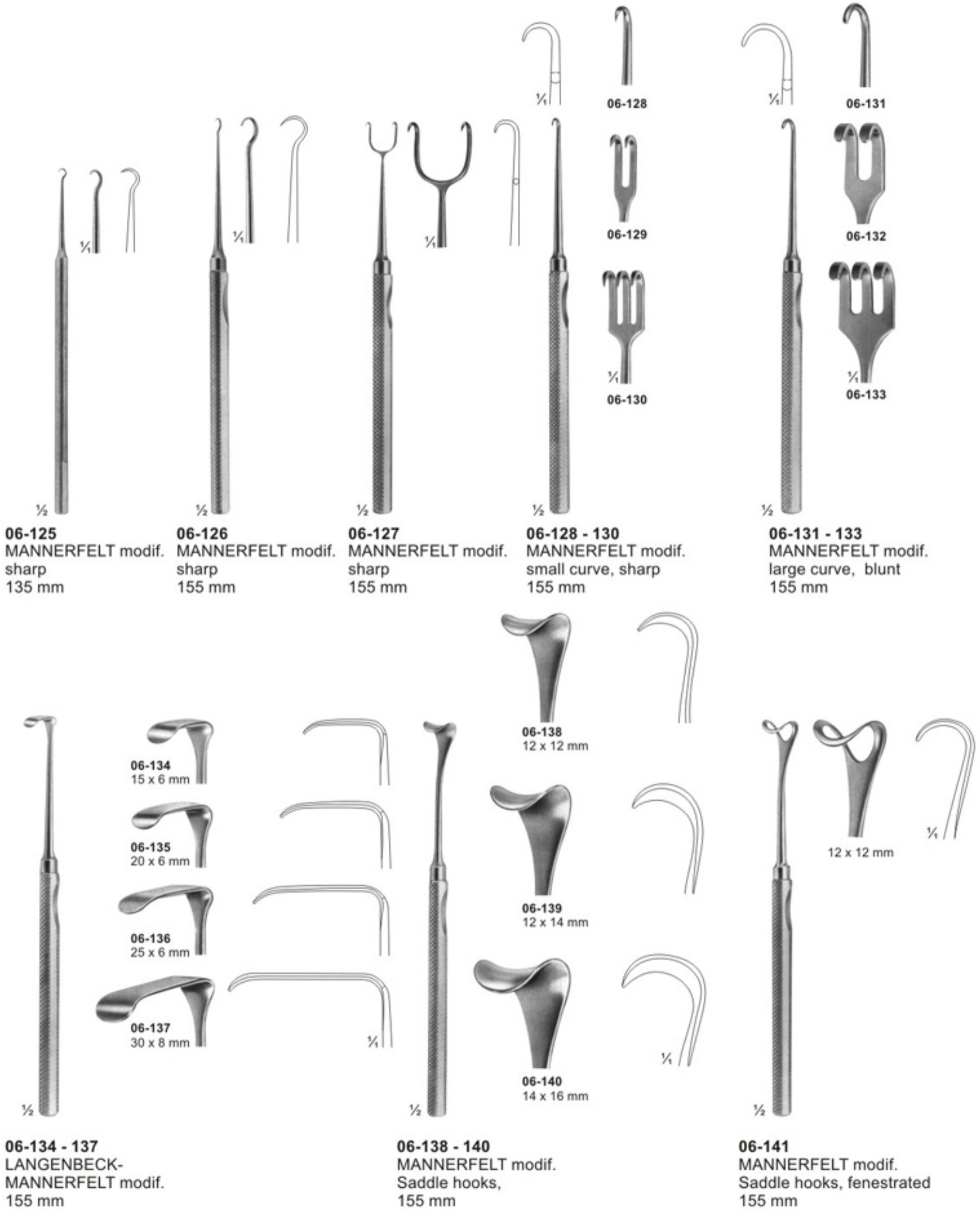

Retractors

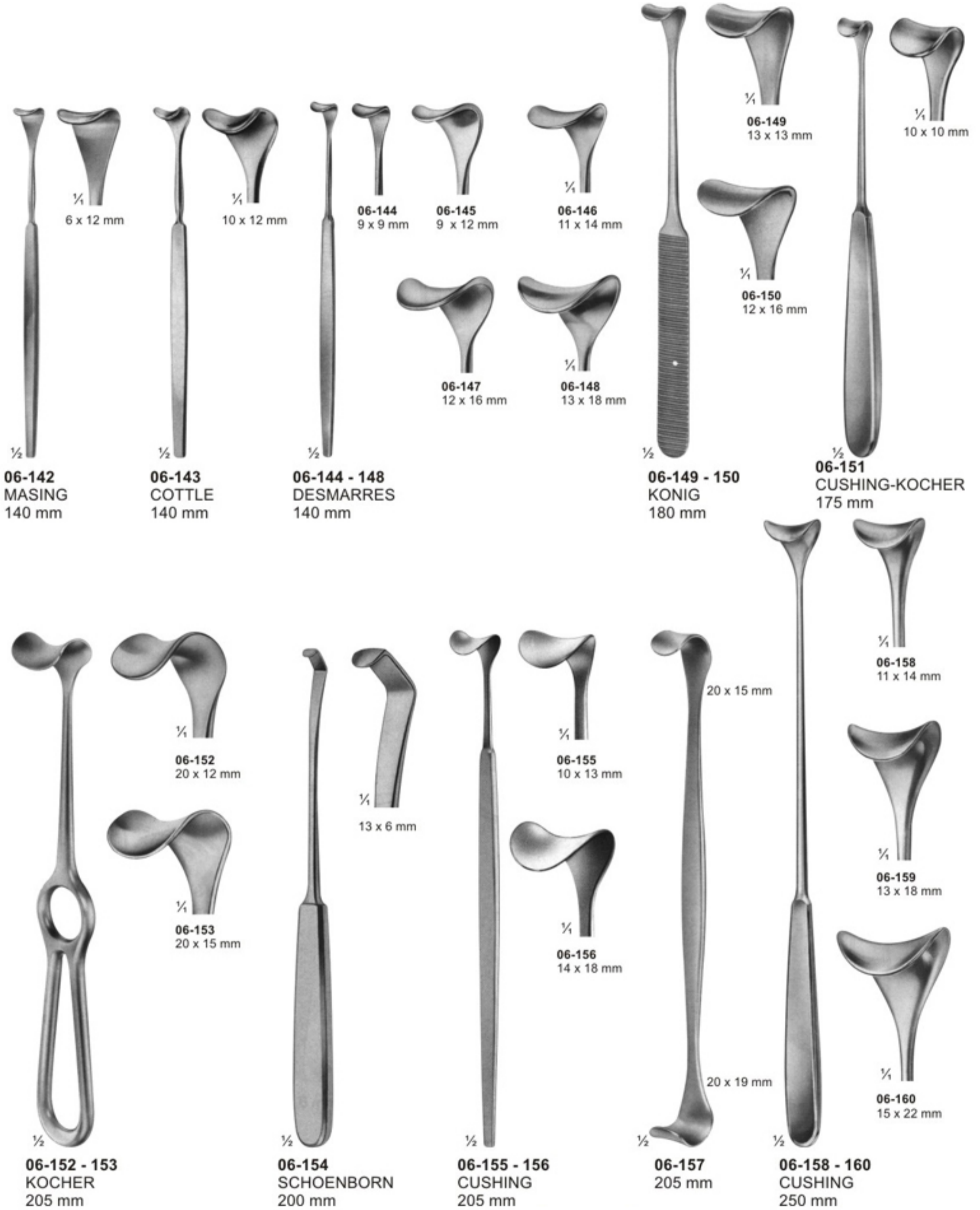

Retractors

 <p>1/2</p>	 <p>19 x 22 mm</p> <p>1/4</p>	 <p>25 x 26 mm</p> <p>1/4</p>	 <p>28 x 29 mm</p> <p>1/4</p>	 <p>1/2</p>	 <p>20 x 22 mm</p> <p>1/4</p>	 <p>25 x 26 mm</p> <p>1/4</p>
<p>06-161 - 163 ROUX Set 165 mm</p>	<p>06-161 23 x 30 mm</p>	<p>06-162 28 x 38 mm</p>	<p>06-163 33 x 45 mm</p>	<p>06-164 - 165 ROUX</p>	<p>06-164 25 x 29 mm 150 mm</p>	<p>06-165 30 x 38 mm 160 mm</p>
 <p>1/2</p>	 <p>36 mm</p> <p>38 x 42 mm</p>	 <p>47 x 13 mm 41 x 13 mm</p> <p>37 x 25 mm 42 x 25 mm</p>	 <p>1/2</p>	 <p>26 x 15 mm 22 x 15 mm</p> <p>39 x 15 mm 43 x 15 mm</p>	 <p>1/2</p>	
<p>06-166 CZERNY 175 mm</p>		<p>06-167 MATHIEU 200 mm</p>		<p>06-168 US-ARMY 220 mm</p>		

Retractors

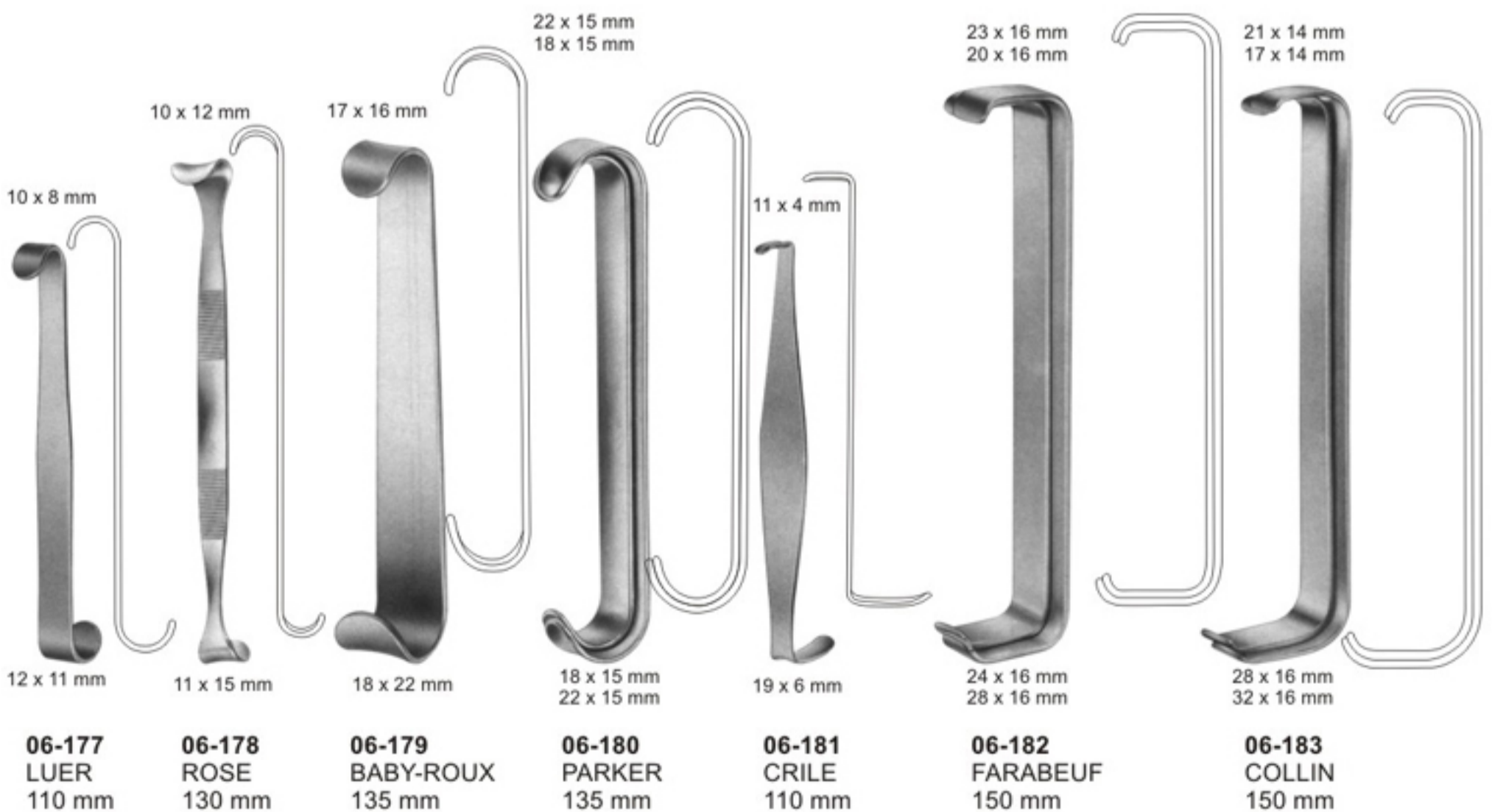

Bone Retractors and Retractors



06-184
KOCHER
sharp
205 mm



06-185
KOCHER
sharp
220 mm



06-186
KOCHER
sharp
220 mm



06-187
VOLKMANN
blunt
220 mm



06-188
VOLKMANN
sharp
220 mm



06-189 - 06-196
VOLKMANN
225 mm



Sharp

1/4



06-189
9 x 8 mm



06-190
9 x 13 mm



06-191
9 x 19 mm



06-192
9 x 29 mm



Blunt

1/4



06-193
8,5 x 8 mm



06-194
8,5 x 13 mm



06-195
8,5 x 19 mm



06-196
8,5 x 29 mm

Retractors

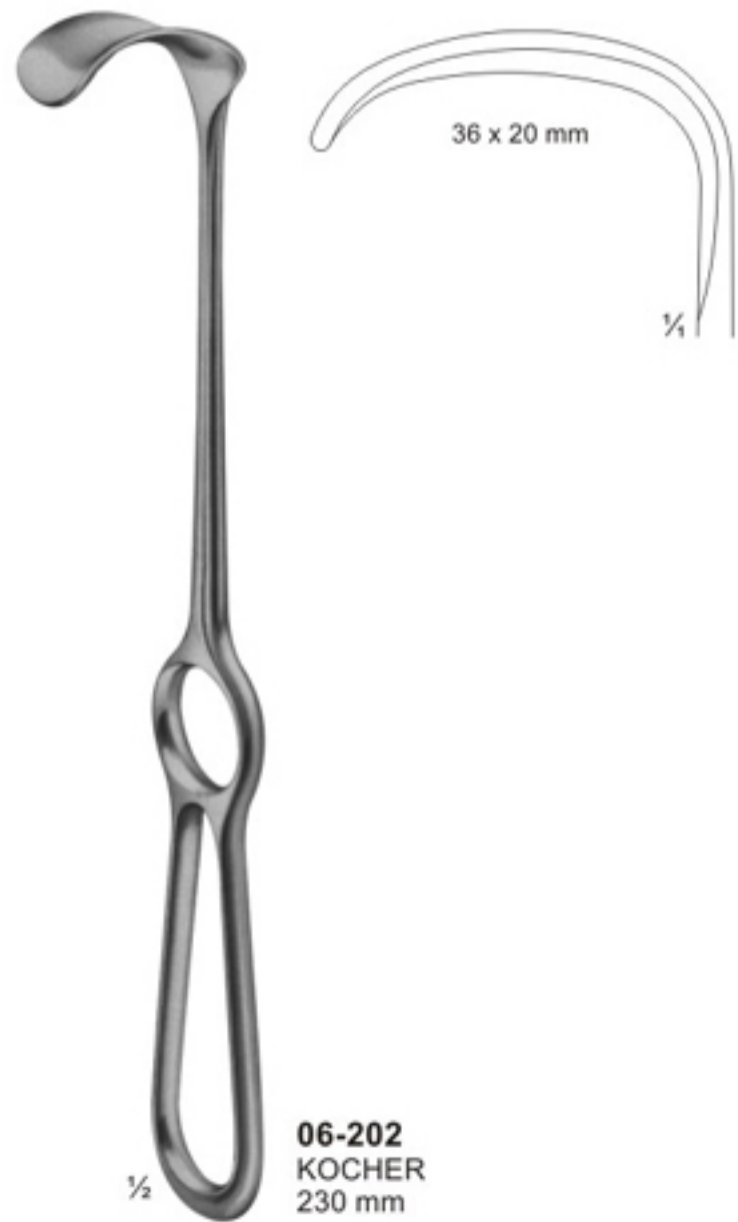
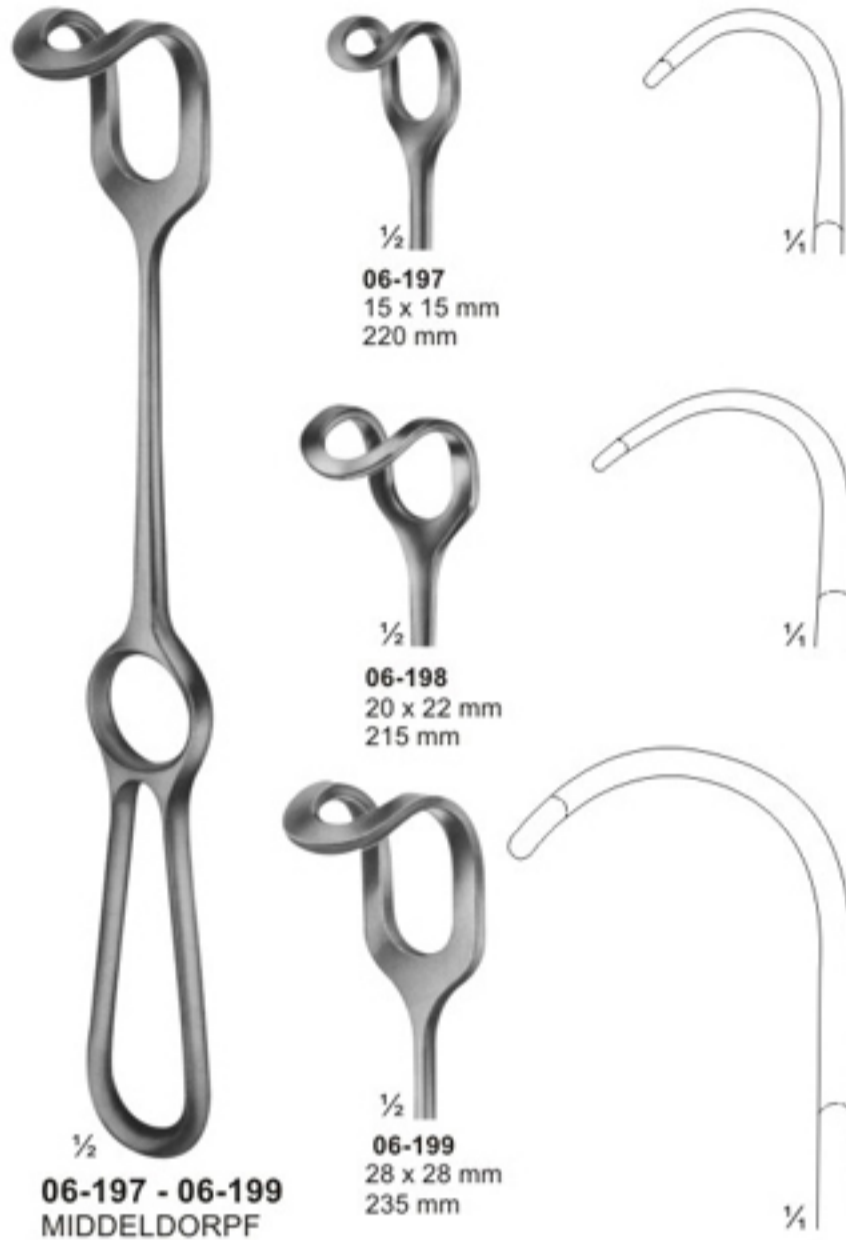

Retractors, Vario Retractor System

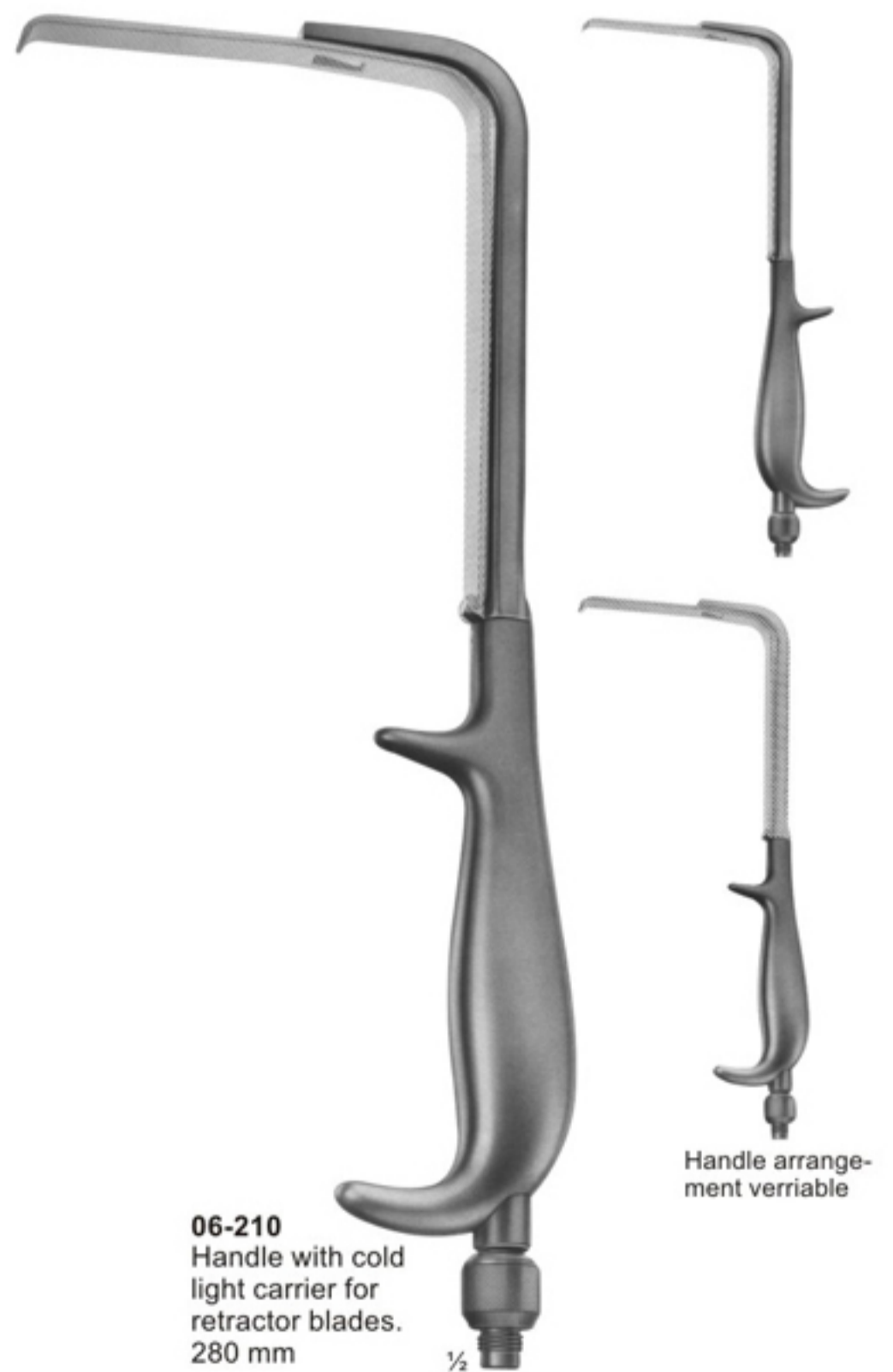
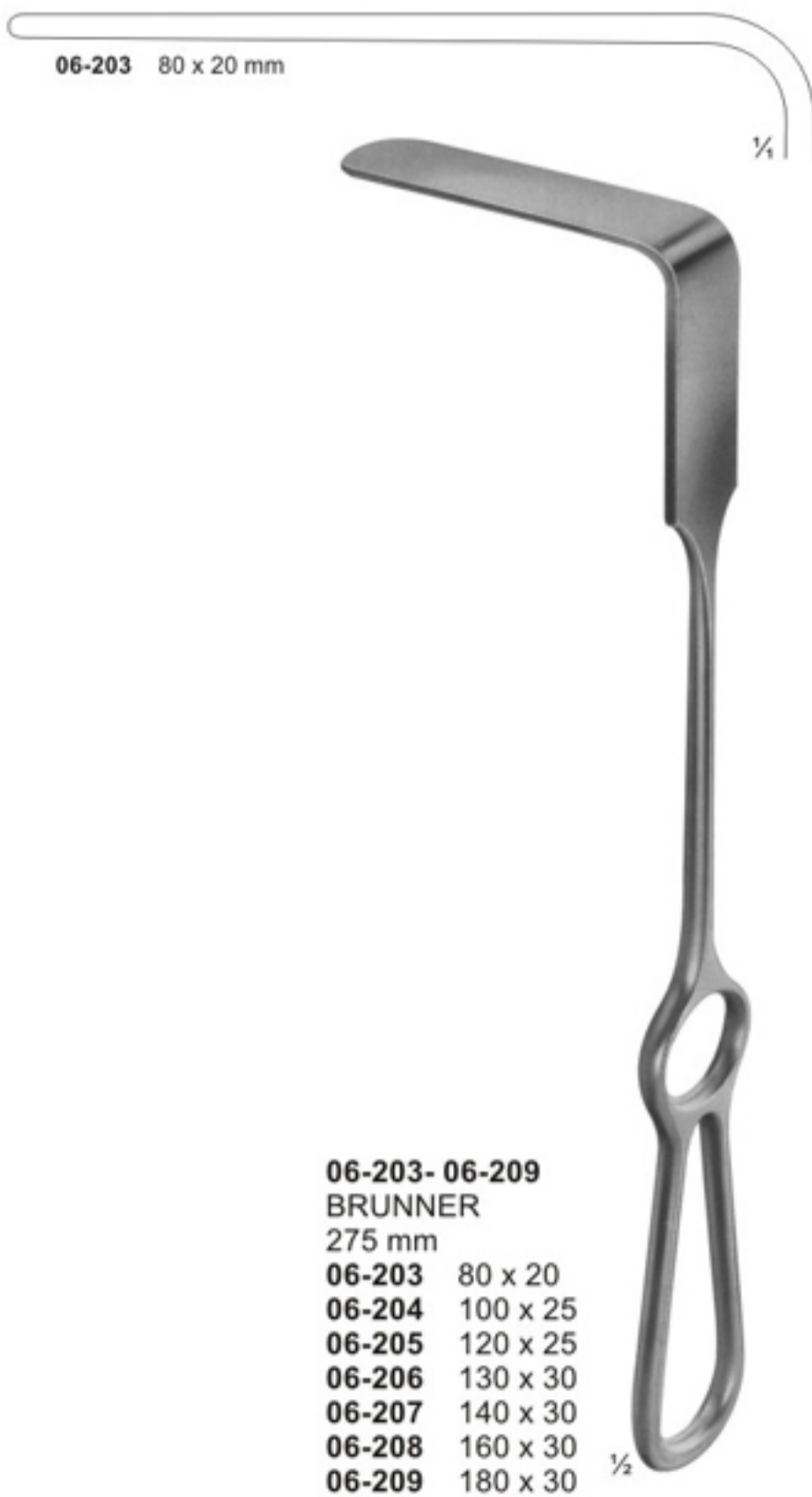

Retractors, Lung Spatulas



Retractors for deep surgery (Abdominal Retractors)

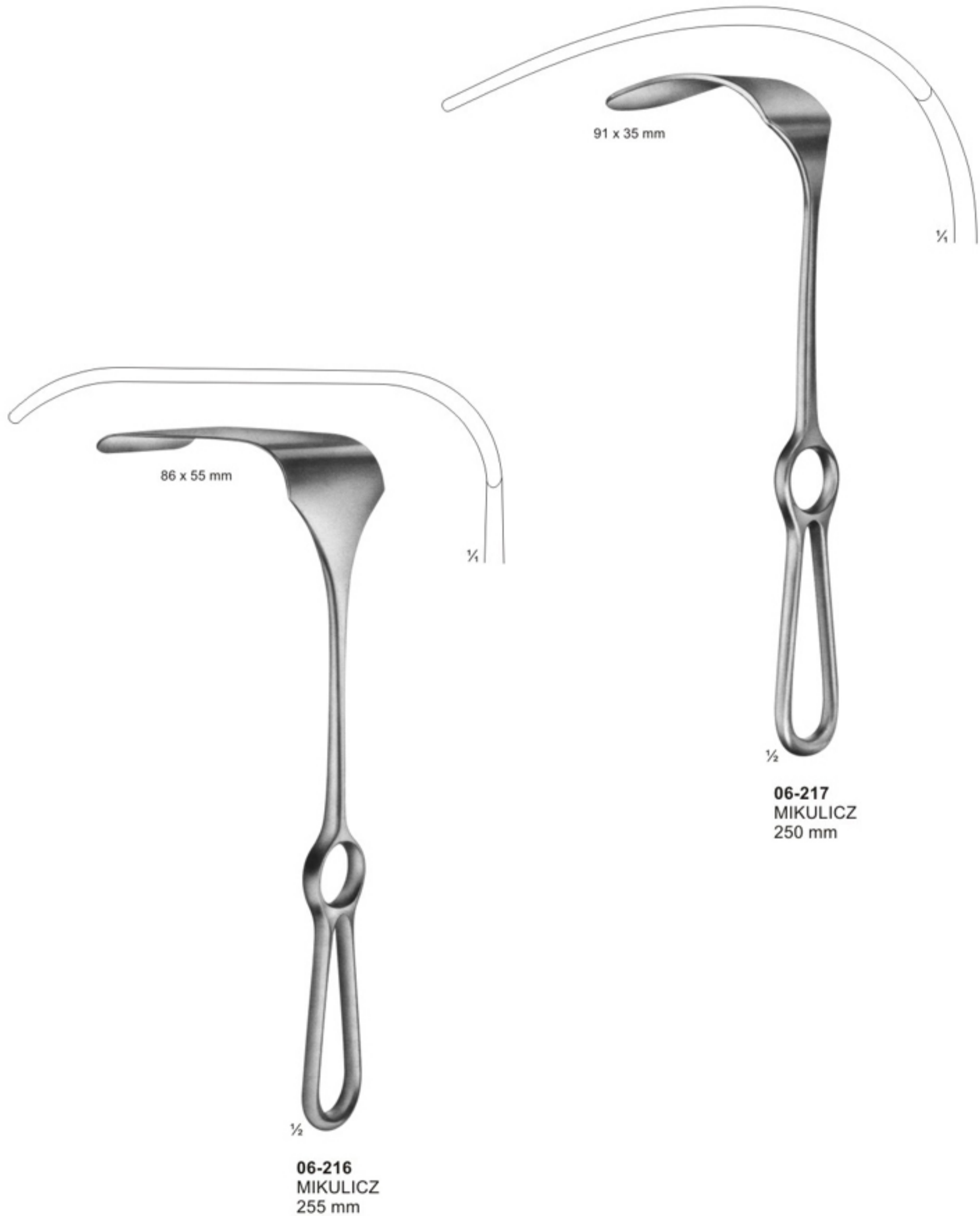

Retractors, Abdominal Retractors

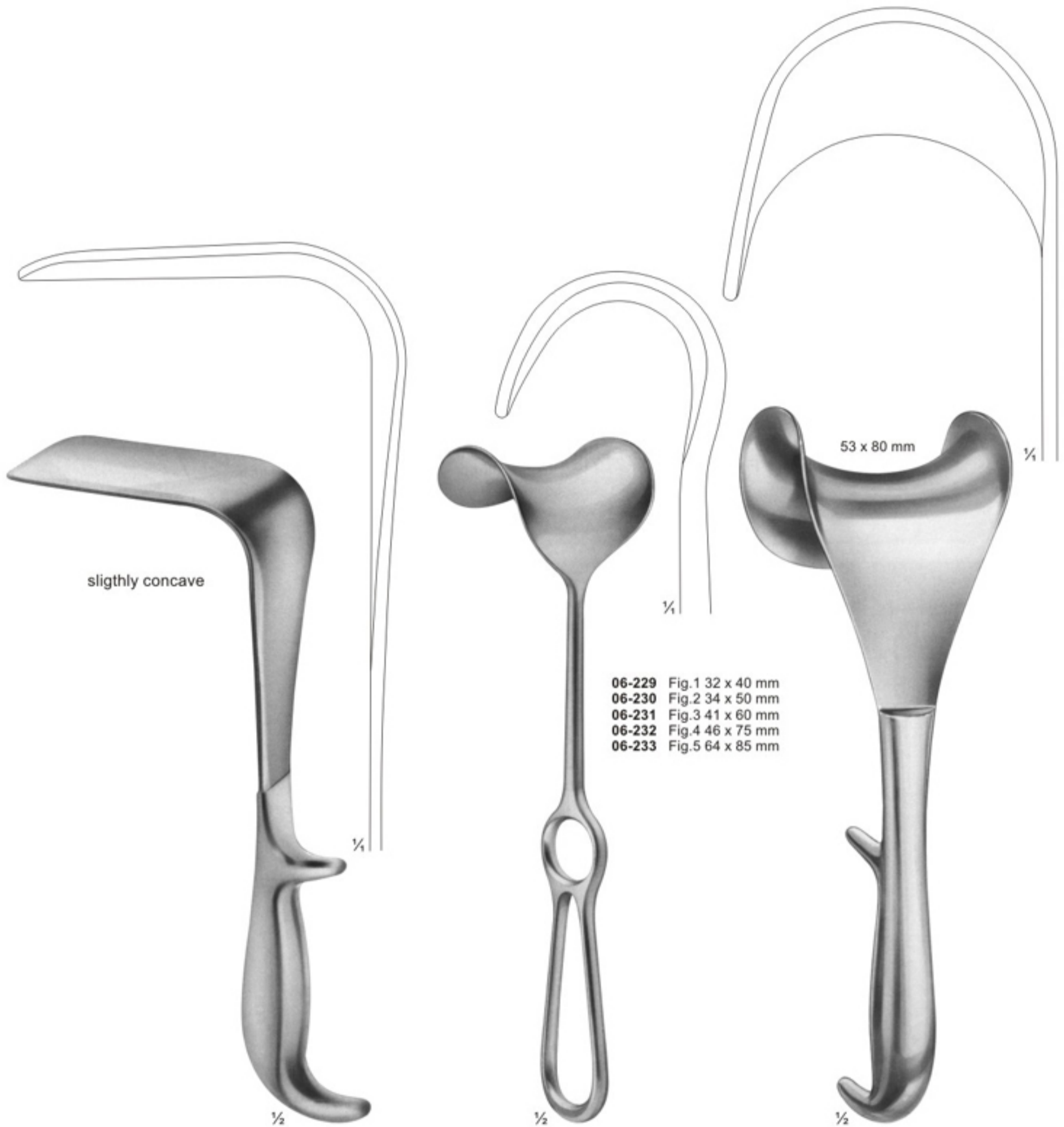

- 06-229 Fig.1 32 x 40 mm
- 06-230 Fig.2 34 x 50 mm
- 06-231 Fig.3 41 x 60 mm
- 06-232 Fig.4 46 x 75 mm
- 06-233 Fig.5 64 x 85 mm

06-218 - 06-228
DOYEN
240 mm

06-229 - 06-233
FRITSCH
240 mm

06-234
DOYEN
250 mm

	width of blades
	35 mm, 45 mm, 60 mm
length of blades	
62 mm	06-218 , 06-222 , 06-226
92 mm	06-219 , 06-223 , 06-227
122 mm	06-220 , 06-224 , 06-228
160 mm	06-221 , 06-225

**Abdominal- and Intestinal Spatulas
Bauch- und Darmspatel**



06-235
LERICHE
255 mm

06-236
KUMMEL
Mealleable
285 mm

06-237
MIKULICZ
29 mm
250 mm

06-238 - 06-239
KADER
06-238 30 mm
06-239 40 mm
270 mm

Self-Retaining Retractors

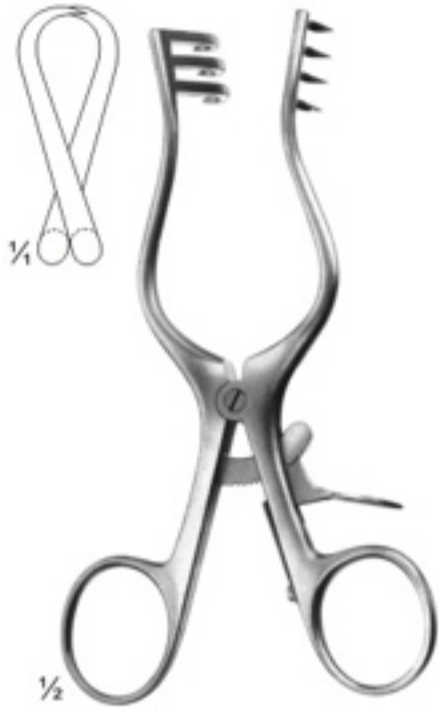

06-240
WEITLANER
sharp
130 mm

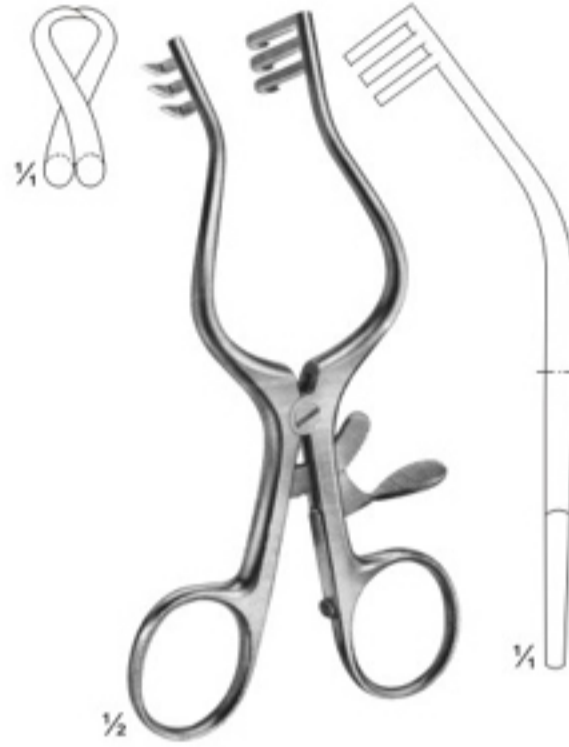

06-241
WULLSTEIN
sharp
130 mm

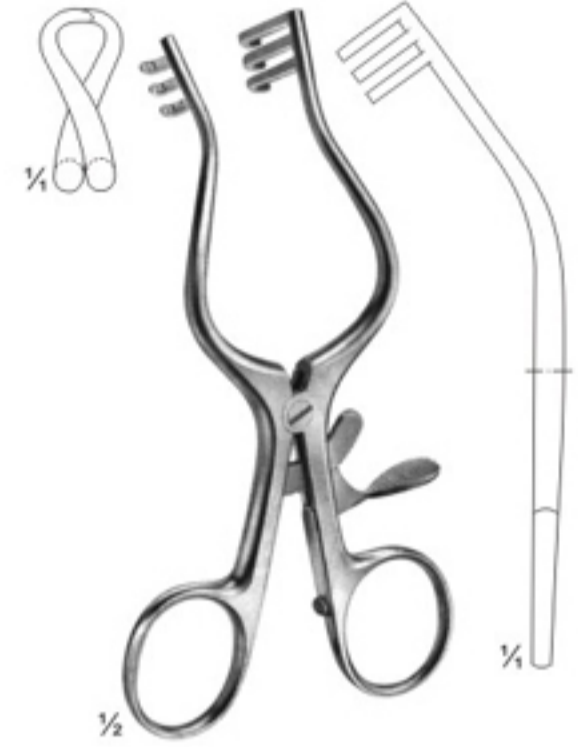

06-242
WULLSTEIN
blunt
130 mm



06-243
WEITLANER
sharp
165 mm



06-244
PLESTER
blunt
110 mm

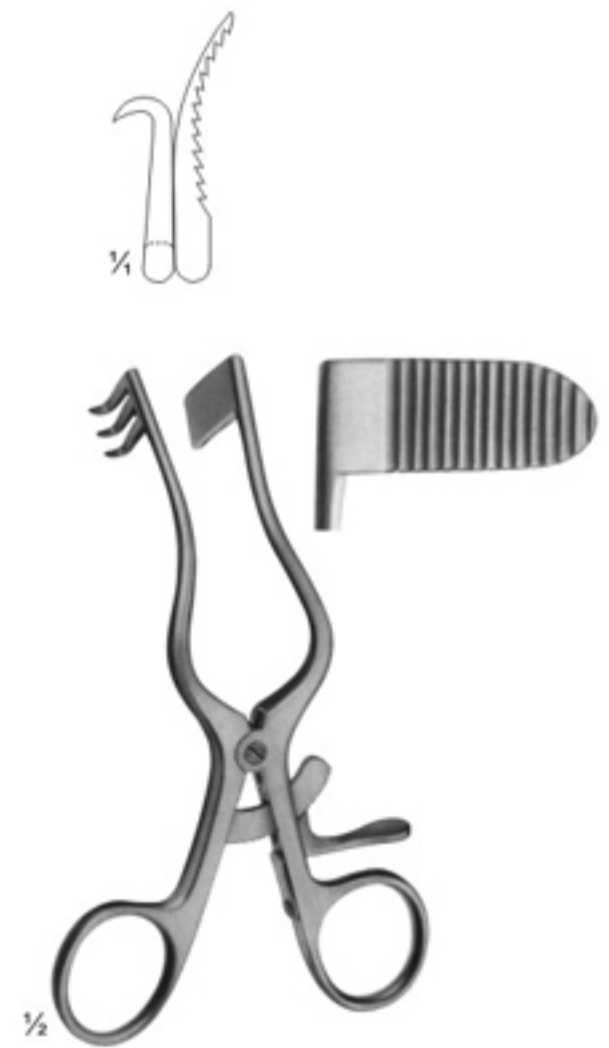

06-245
PERKINS
blunt
130 mm

Special Retractors



06-246
JOLL (FRIEDMAN)
Thyroid- and vaginal retractor
155 mm

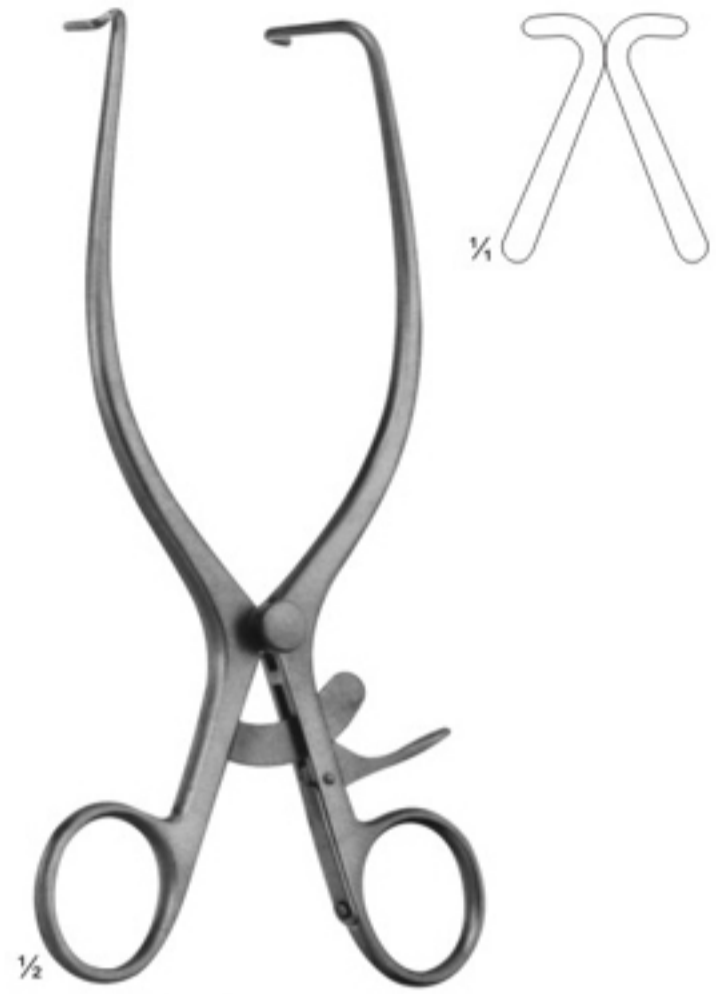

06-247
JACKSON BURROWS
Retractor, blunt
185 mm



06-248
GELPI
Vaginal retractor
135 mm



06-249
GELPI
Skin- and vaginal retractor
175 mm



06-250
DE BAKEY
Femur retractor
145 mm

Lamina Spreaders



06-251
CLOWARD
155 mm



06-252
CLOWARD
135 mm



06-253
INGE
170 mm

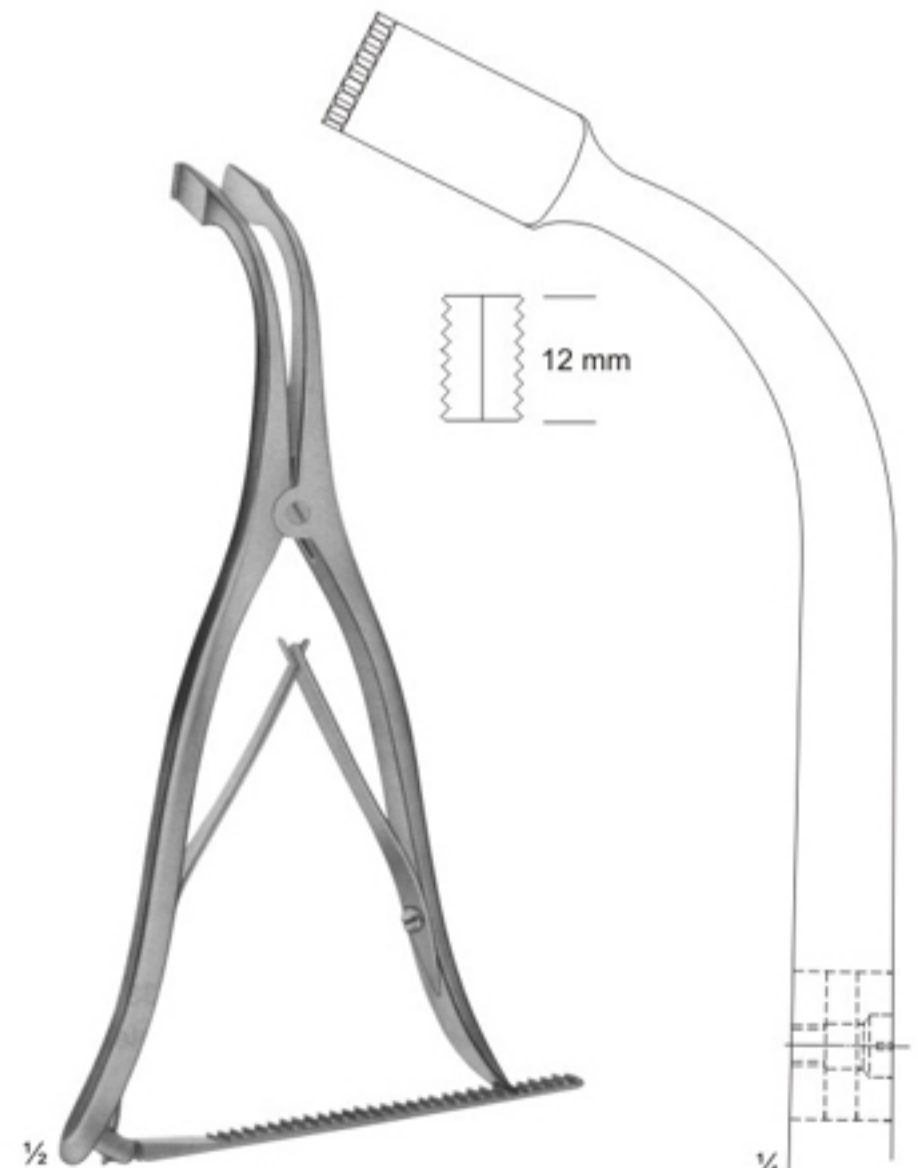

06-254
INGE
275 mm

Abdominal Retractors



06-255
GOSSET
Blades: 38 mm deep

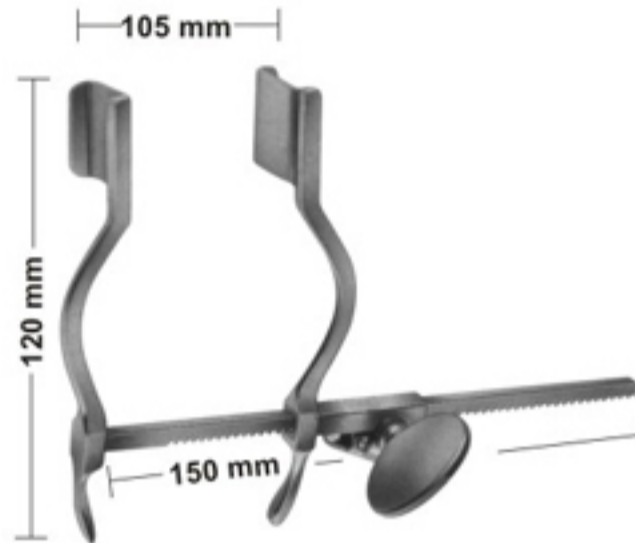

06-256
HERTZLER
Blades 20 X 25 mm

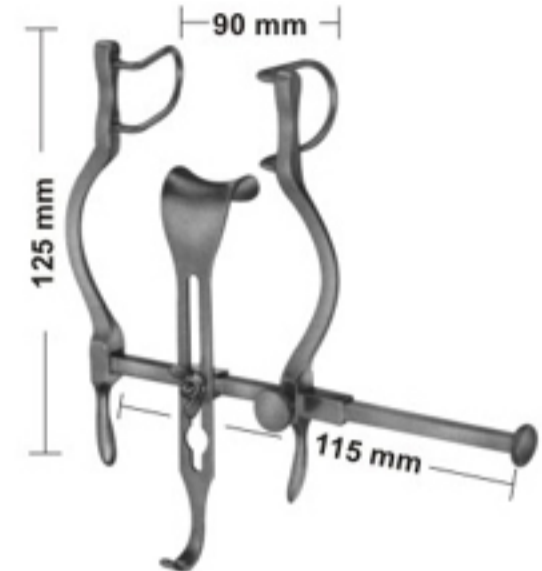

06-257
BALFOUR-BABY
Lateral blades 27 mm deep
Center blade 21x24 mm

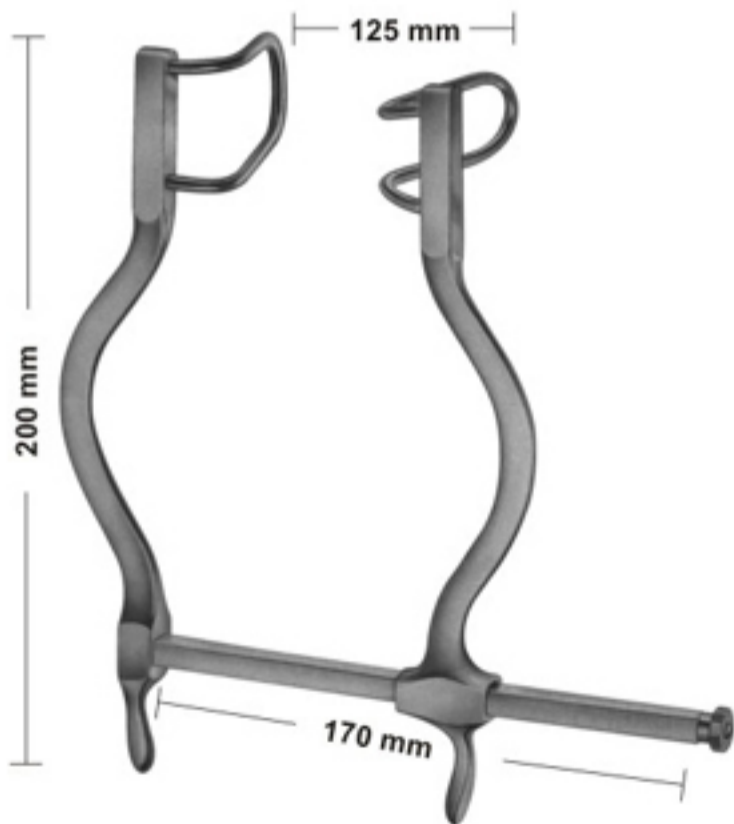

06-258
GOSSET
Blades: 55 mm deep

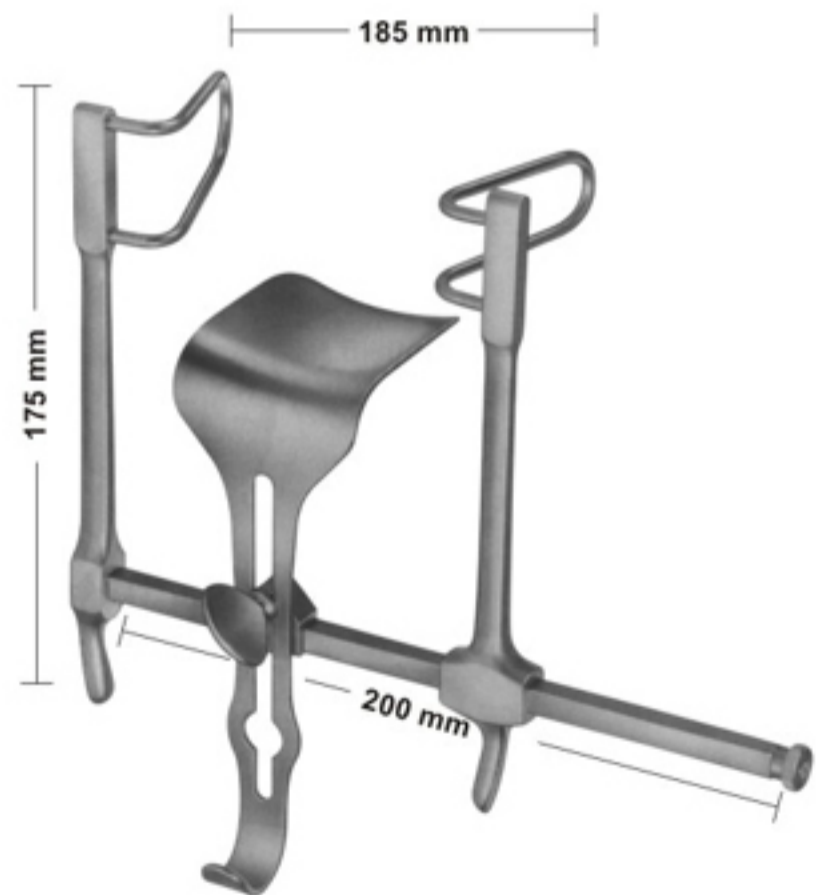

06-259
GOSSET
Lateral blades 58 mm deep
Center blade 59 x 57 mm

Abdominal Retractors

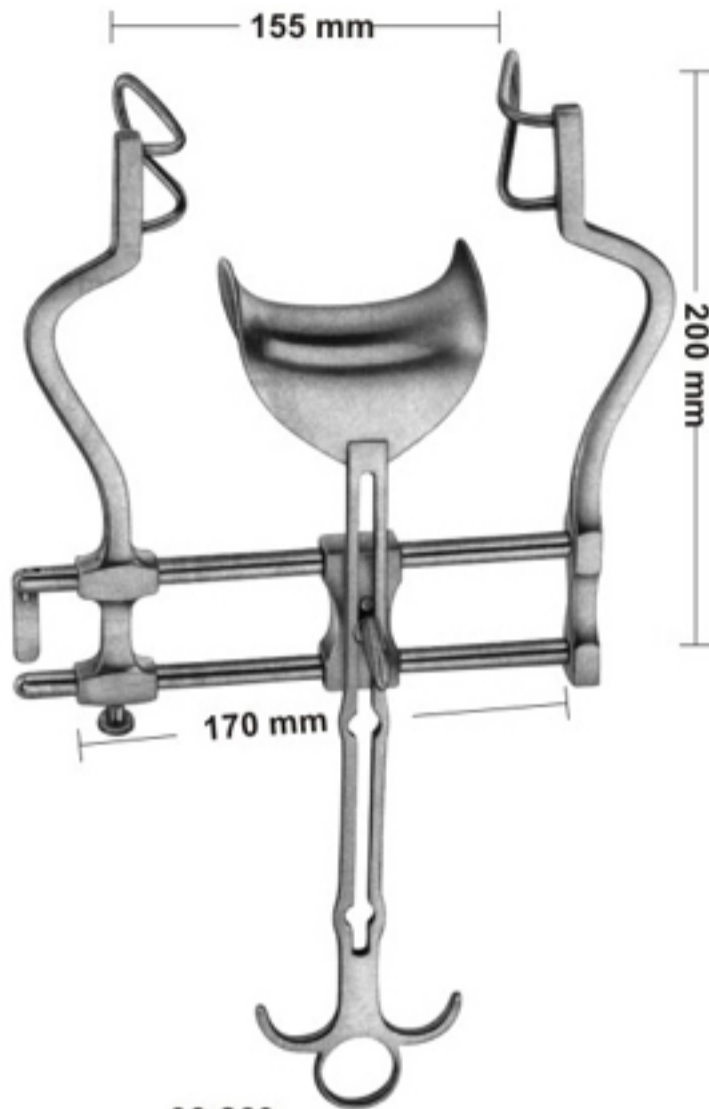

06-260
BALFOUR
Lateral blades 60 mm deep
Center blade 47 x 80 mm

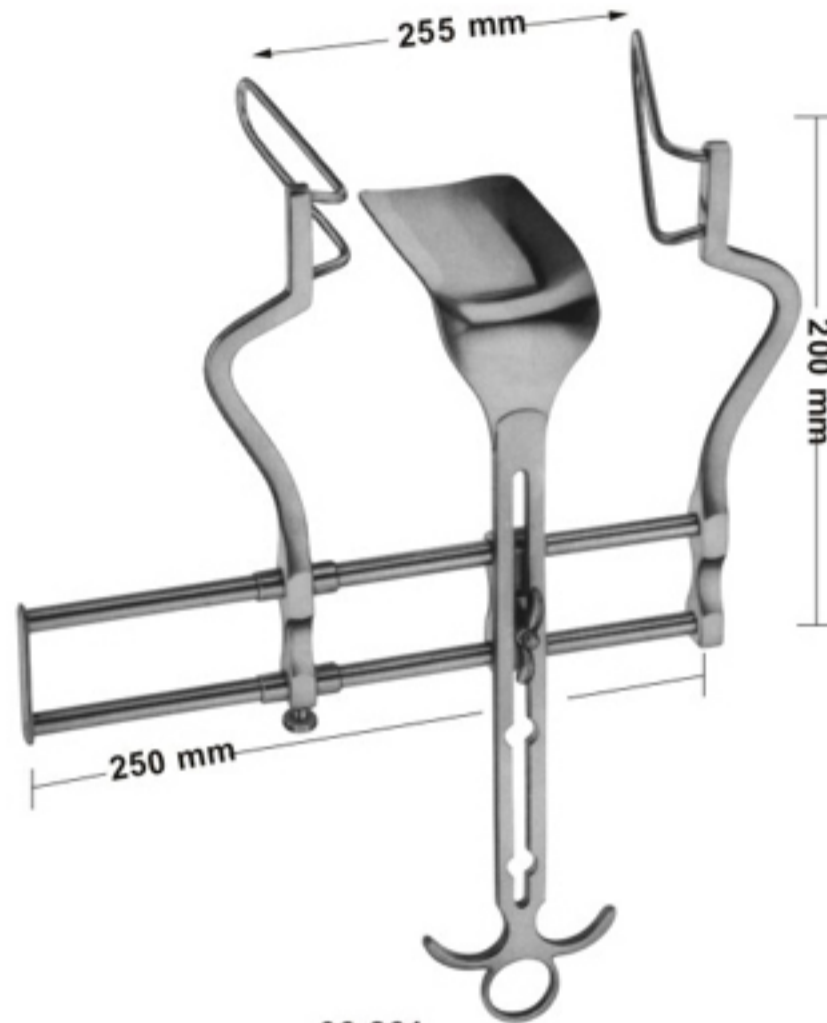

06-261
BALFOUR
Lateral blades 105 mm deep
Center blade 107x 59 mm



06-262
Center blade only
54x80 mm

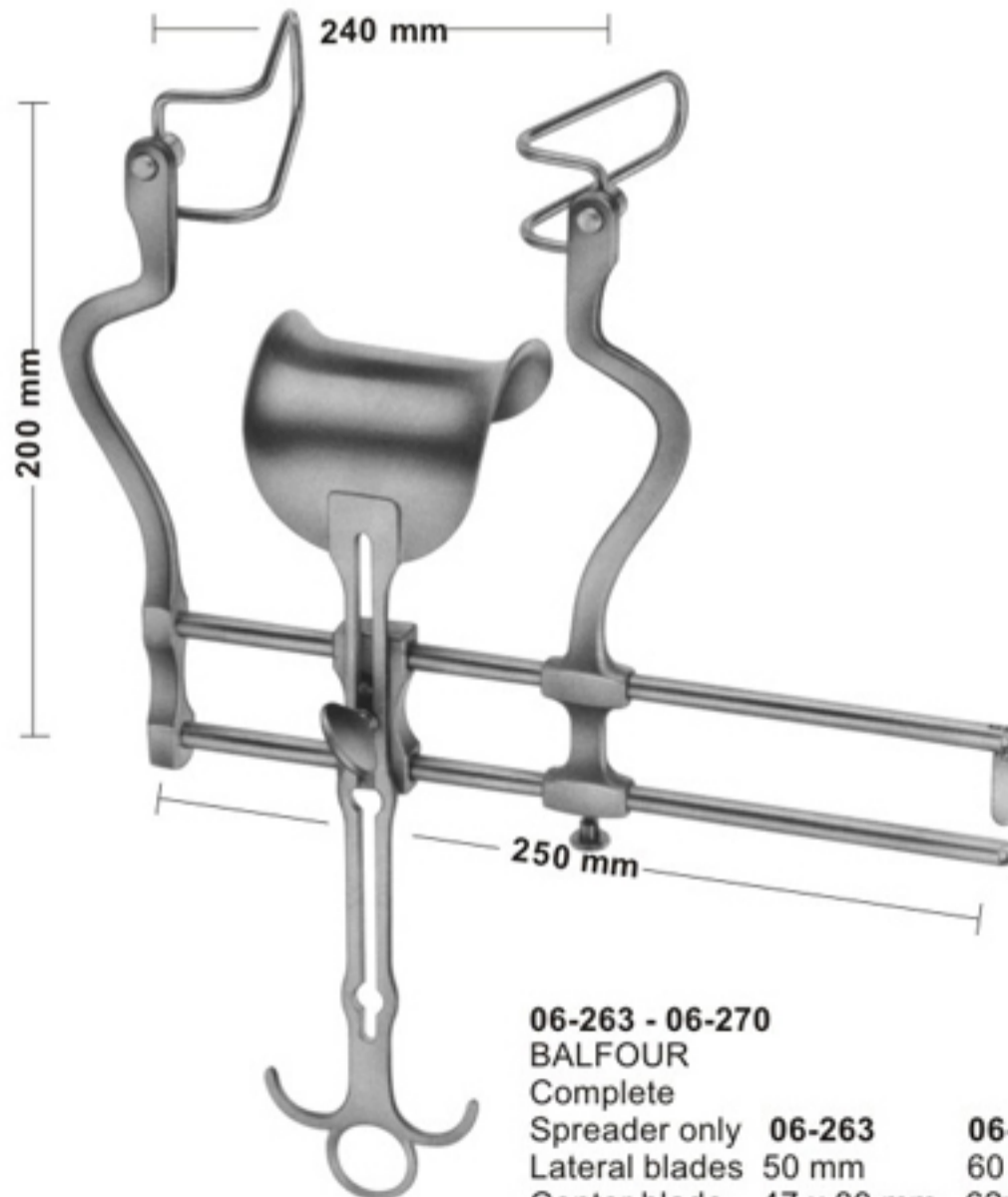

06-263 - 06-270
BALFOUR
Complete

Spreader only	06-263	06-264	06-265	06-266
Lateral blades	50 mm	60 mm	75 mm	90 mm
Center blade	47 x 80 mm	62x76 mm	80x80 mm	80x80 mm



Lateral blades
06-267 50 mm deep
06-268 60 mm deep
06-269 75 mm deep
06-270 90 mm deep
Sales Unit of blades:PR = pair

Organ-, Tissue and Intestinal Grasping Forceps

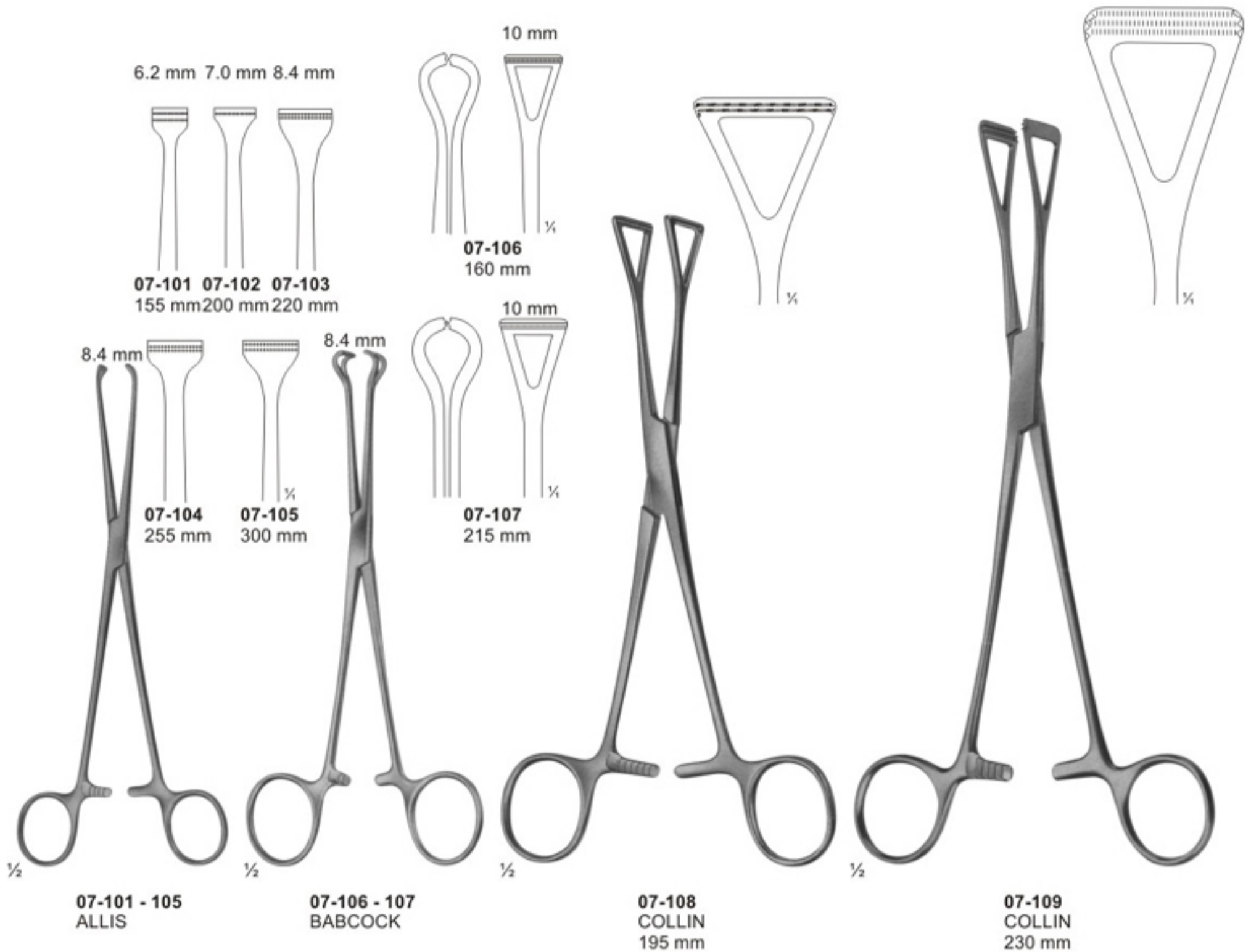

Intestinal Clamps, soft elastic

ATRAUMATA

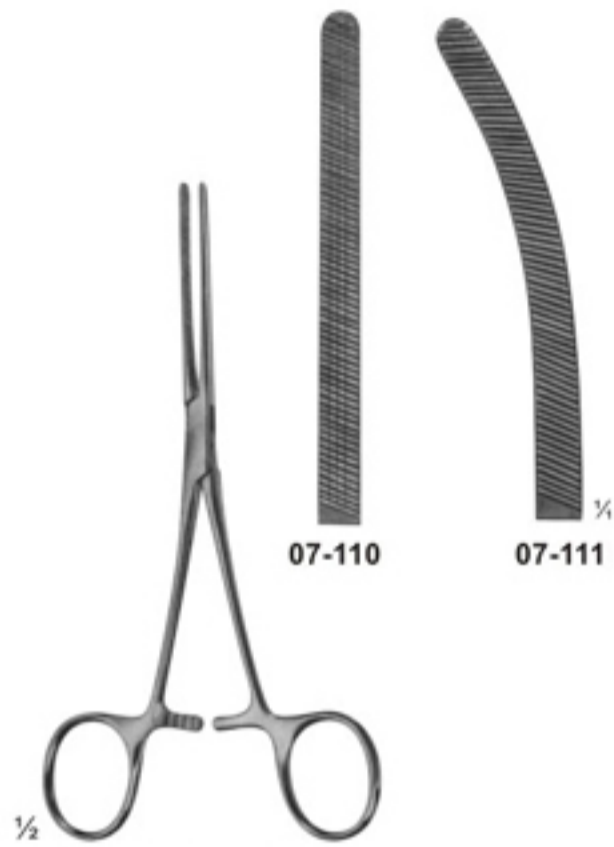

07-110 - 111
DOYEN
elastic
165 mm

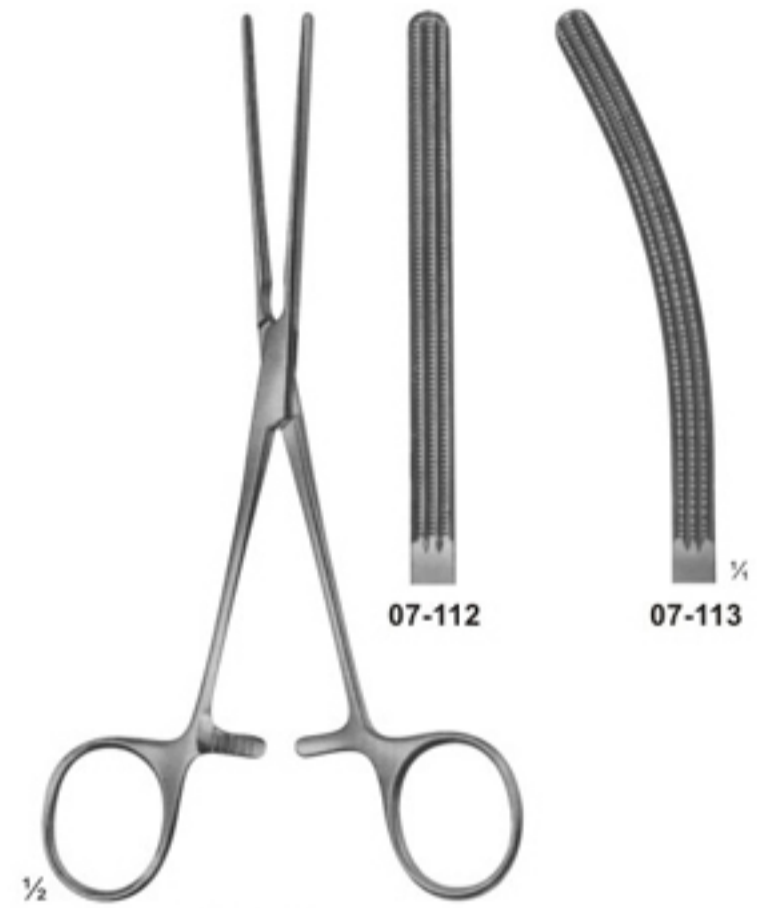

07-112 - 113
DOYEN
with elastic blades
170 mm

ATRAUMATA

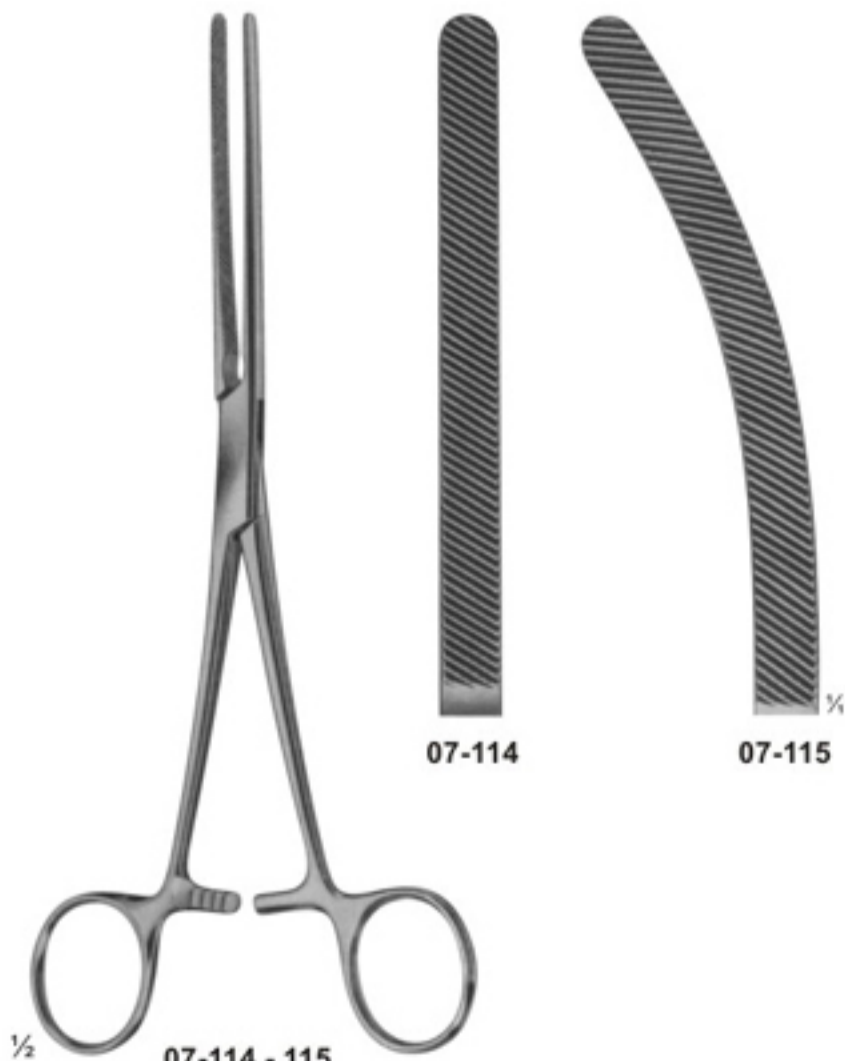

07-114 - 115
HARTMANN
with elastic blades
200 mm

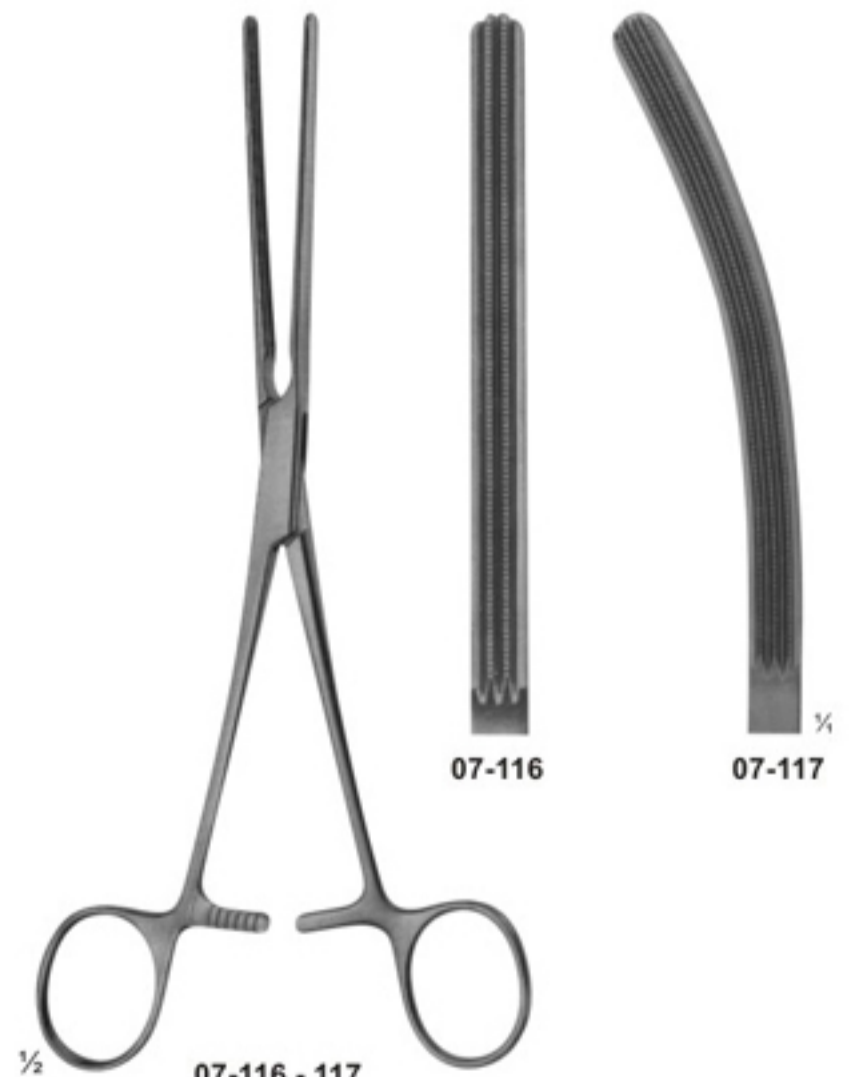

07-116 - 117
HARTMANN
with elastic blades
200 mm

Intestinal and Pylorus Clamps



1/2
07-118
PAYR
Intestinal clamp
light pattern,
for children
180 mm

1/2
07-119
PAYR
200 mm

1/2
07-120
PAYR
275 mm

1/2
07-121
PAYR
Pylorus clamp
315 mm

ATRAUMATA

Sigmoid Anastomosis Forceps

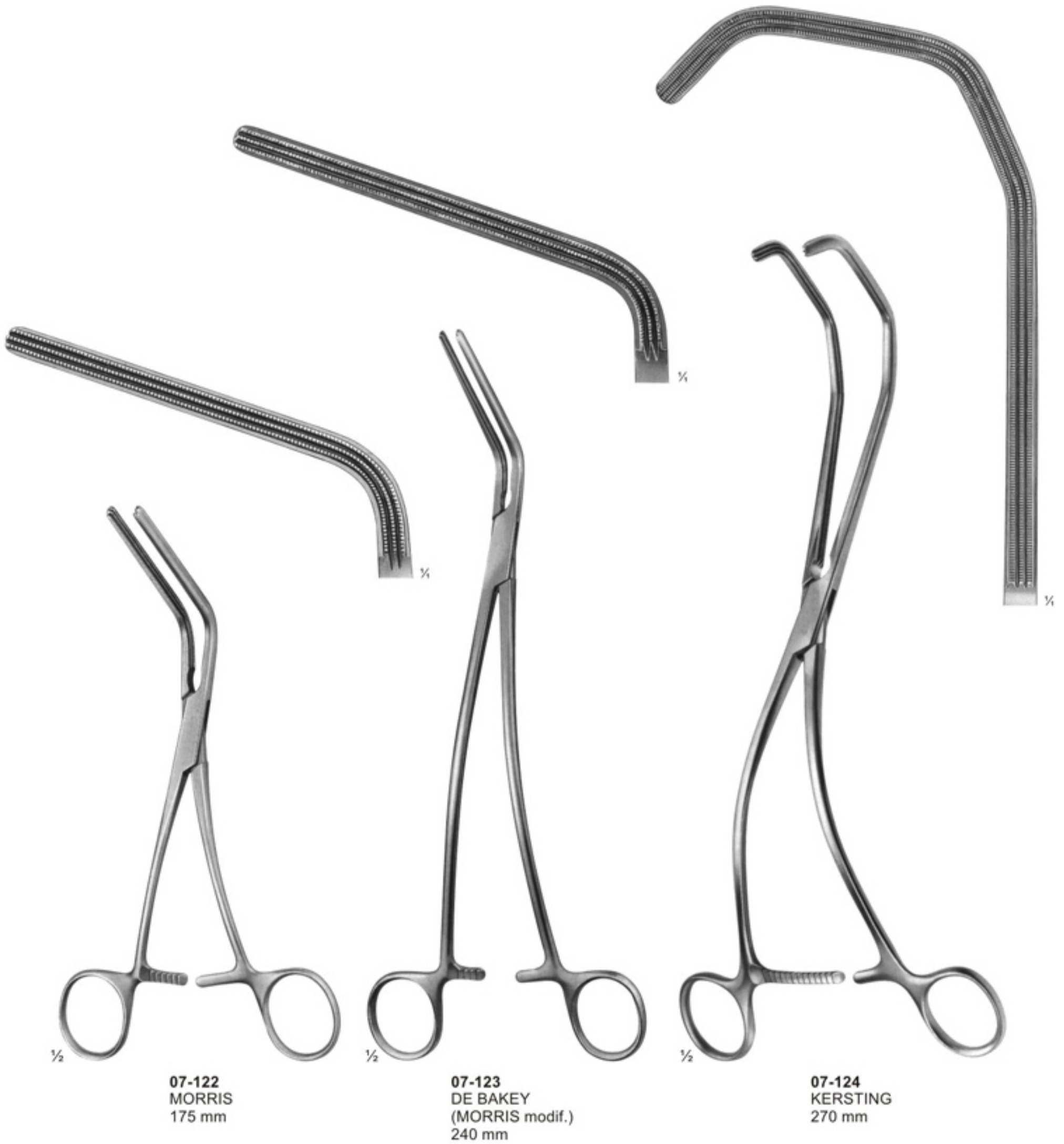

1/2

07-122
MORRIS
175 mm

1/2

07-123
DE BAKEY
(MORRIS modif.)
240 mm

1/2

07-124
KERSTING
270 mm

Nasal Specula



08-101
Martin
13 cm / 5 1/8"



08-102
SIMS
160 mm

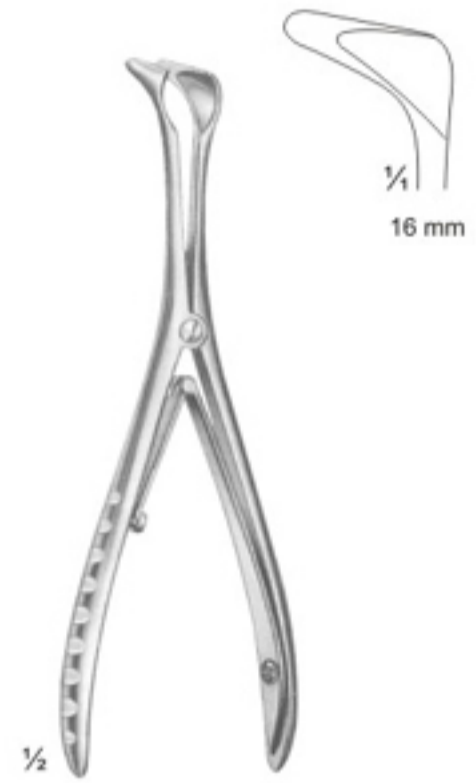

08-103
Tieck-Halle
13 cm / 5 1/8"



08-104
Killian

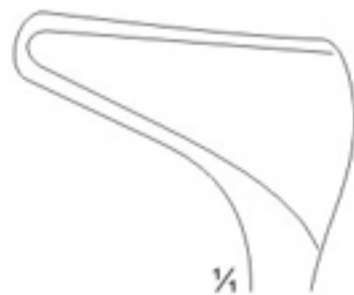

Fig. 1
14 cm 5 4/8"
35 mm



Fig. 2
14,5 cm / 5 4/8"
50 mm

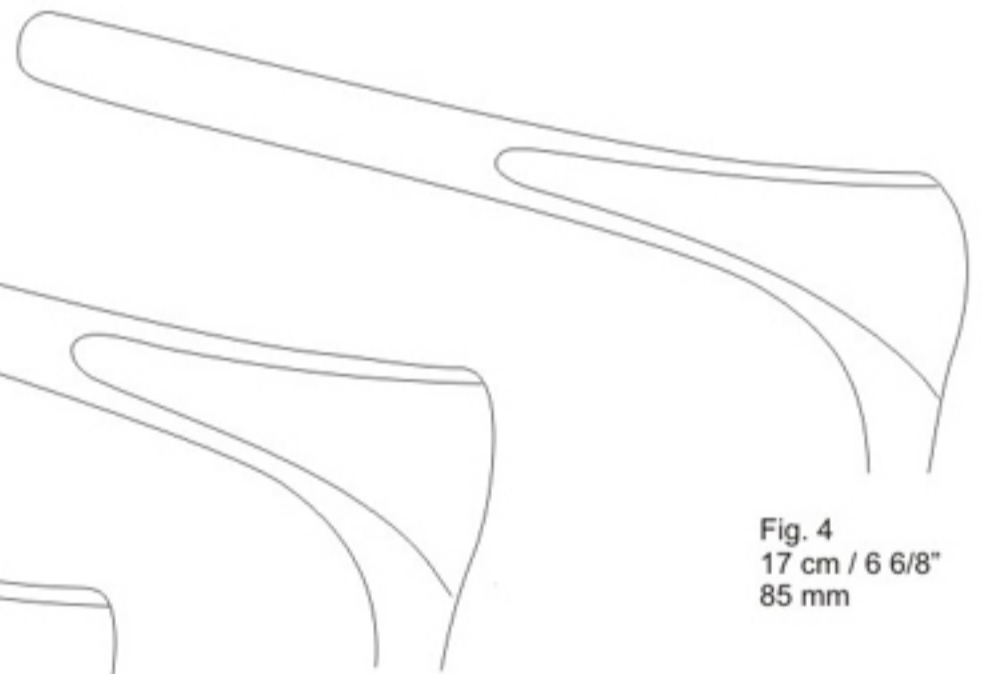

Fig. 3
16 cm / 6 2/8"
75 mm

Fig. 4
17 cm / 6 6/8"
85 mm

Nasal Specula



08-105
Cottle

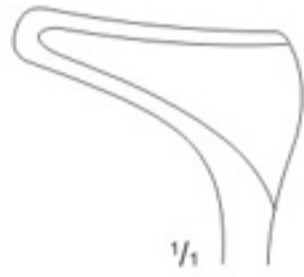

Fig. 1
13,5 cm / 5 3/8"
35 mm



Fig. 2
14 cm / 5 4/8"
50 mm



Fig. 3
16 cm / 6 2/8"
75 mm



Fig. 4
16 cm / 6 2/8"
85 mm



08-106
Goldsmith (Thudichum)
6,5 cm / 2 4/8"



Fig. 1
21,0 x 9,5 mm



Fig. 2
21,0 x 10,5 mm



Fig. 3
21,0 x 11,5 mm



08-107
Mod. Wien 2
13,5 cm / 5 1/8"



Fig. 1
30 mm



08-108
Hartmann-Halle
16 cm / 6 1/8"



Fig. 1
27 mm



Fig. 2
31 mm

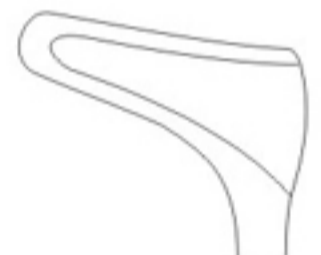

Fig. 3
35 mm

Anusscopes-Sphincteroscopes



08-109
IVES-FANSLER
Anuscope
145 mm
Ø24mm



08-110
KELLY
Sphincteroscope
160 mm
Ø21mm



08-111
KELLY
Sphincteroscope
160 mm
Ø27mm

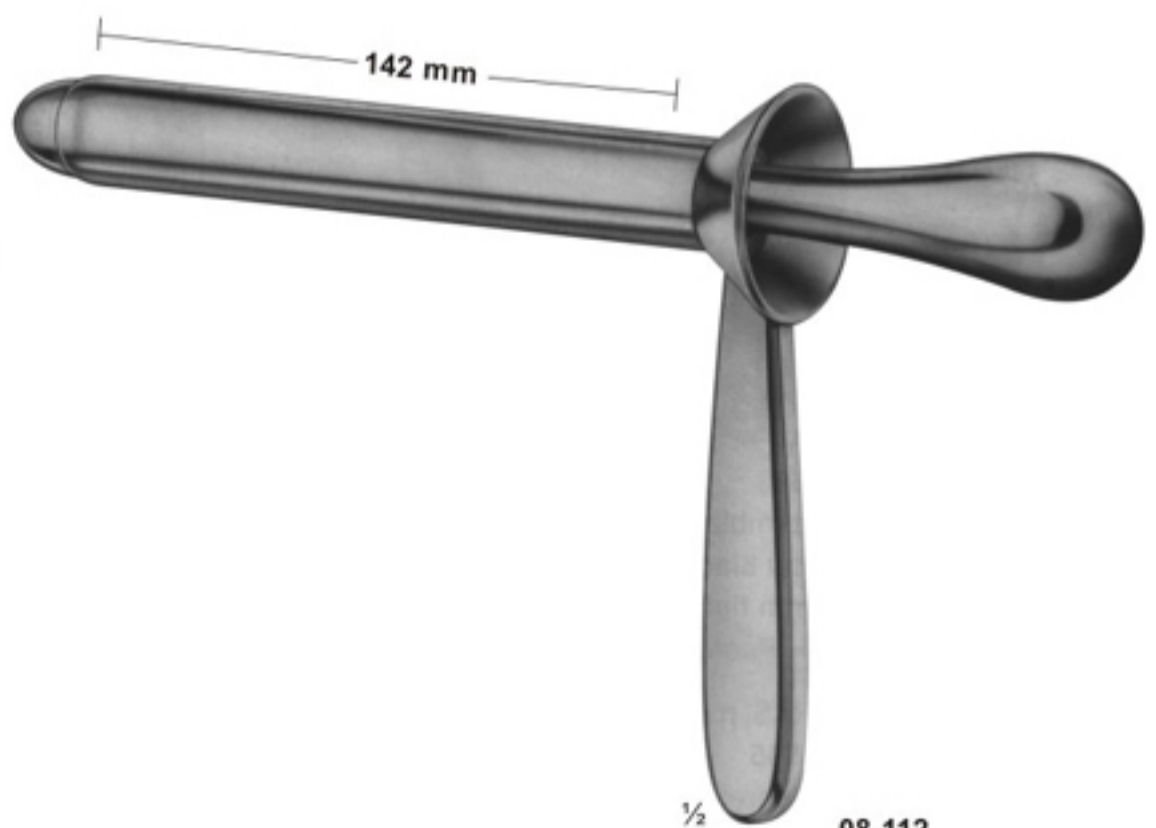

08-112
KELLY
Proctoscope
140 mm
Ø22mm

Haemorrhoidal Forceps

ATRAUMATA

Pressure Clamp

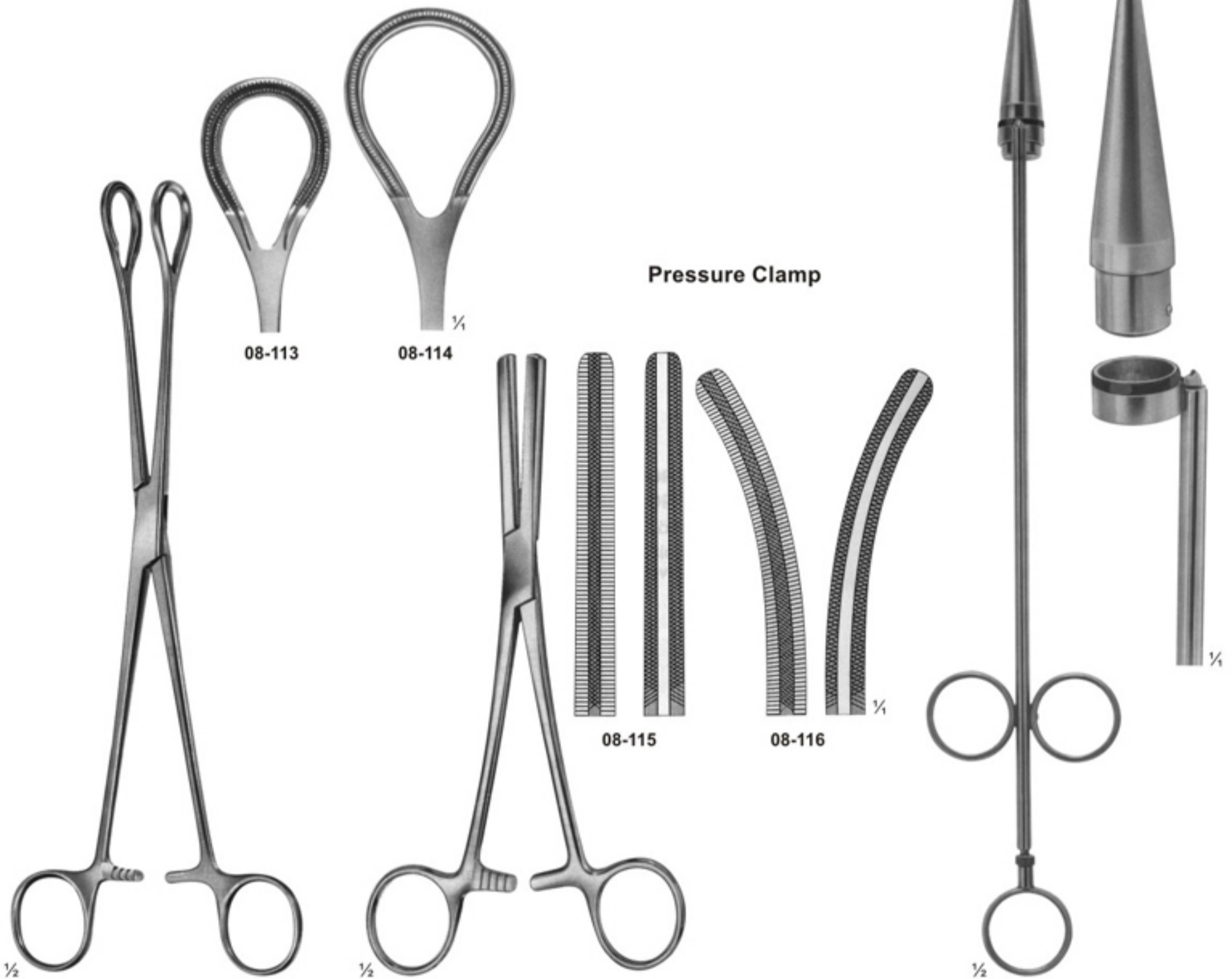

08-113 - 08-114
250 mm
08-114
270 mm

08-115 - 08-116
FERGUSSON
200 mm

08-117
RUDD
Haemorrhoidal ligator
with loading
attachment and 100
ligature rubber rings
315 mm

Gall Duct Forceps



08-118
LOWER
180 mm



08-119
LAHEY (SWEET)
190 mm



08-120
LAHEY
220 mm



08-121
DESJARDINS
Gall duct-and cystic forceps
210 mm



08-122
NISSEN
Gall duct-and cystic forceps
215 mm

Gall Duct Dilators and Gall Stone Scoops

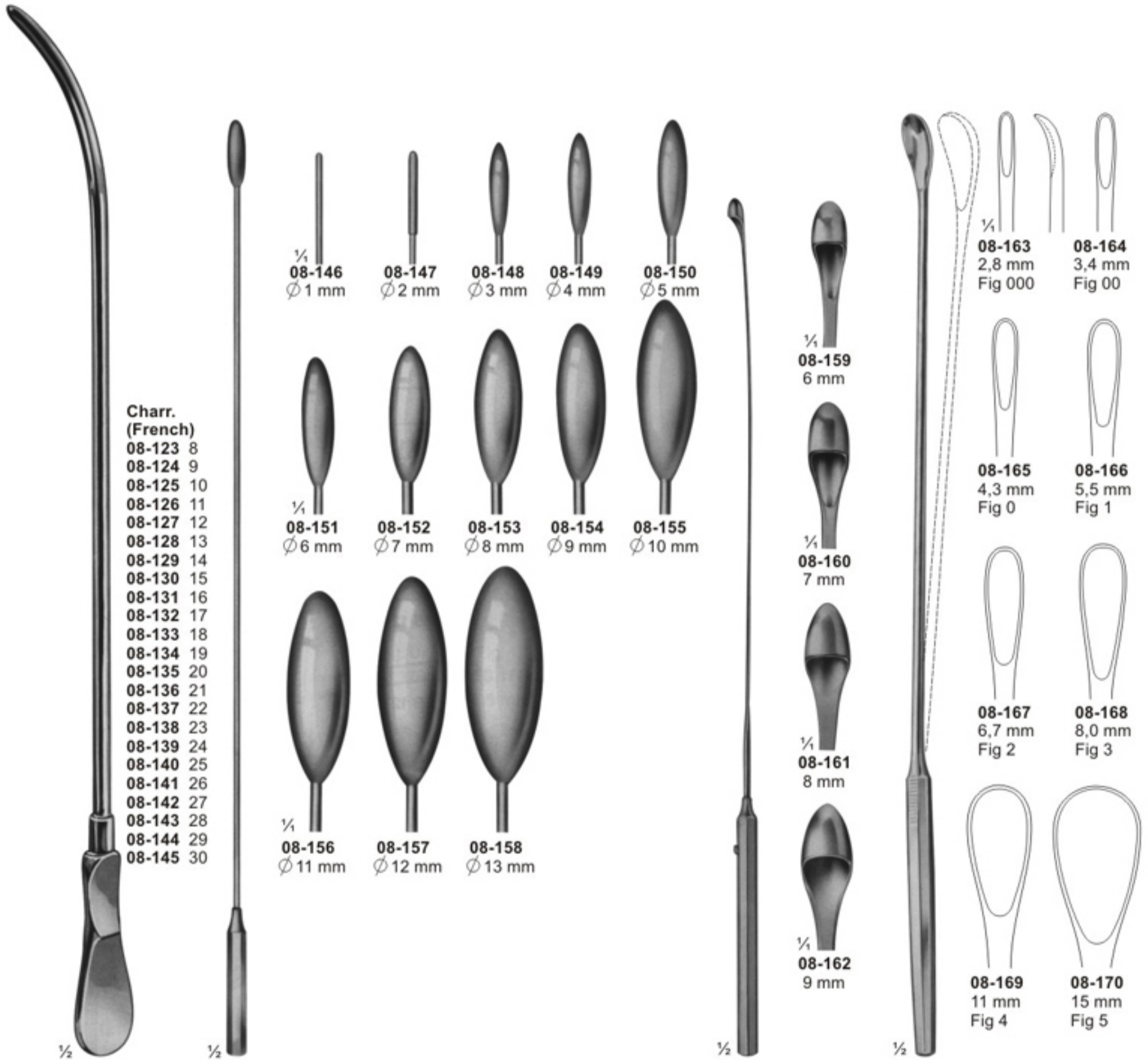

Charr.
(French)
08-123 8
08-124 9
08-125 10
08-126 11
08-127 12
08-128 13
08-129 14
08-130 15
08-131 16
08-132 17
08-133 18
08-134 19
08-135 20
08-136 21
08-137 22
08-138 23
08-139 24
08-140 25
08-141 26
08-142 27
08-143 28
08-144 29
08-145 30

08-123 - 08-145
DITTEL
Metall bougies and
dilating sounds, stiff
345 mm

08-146 - 08-158
BAKES
Common bile duct
dilators, malleable
08-146 - 08-150 315 mm
08-151 - 08-158 320 mm

08-159 - 08-162
DESJARDINS
Probe and catch
with flexible shaft
300 mm

08-163 - 08-170
LUER-KOERTE modif
with malleable shaft
310 mm

Gall Stone Forceps

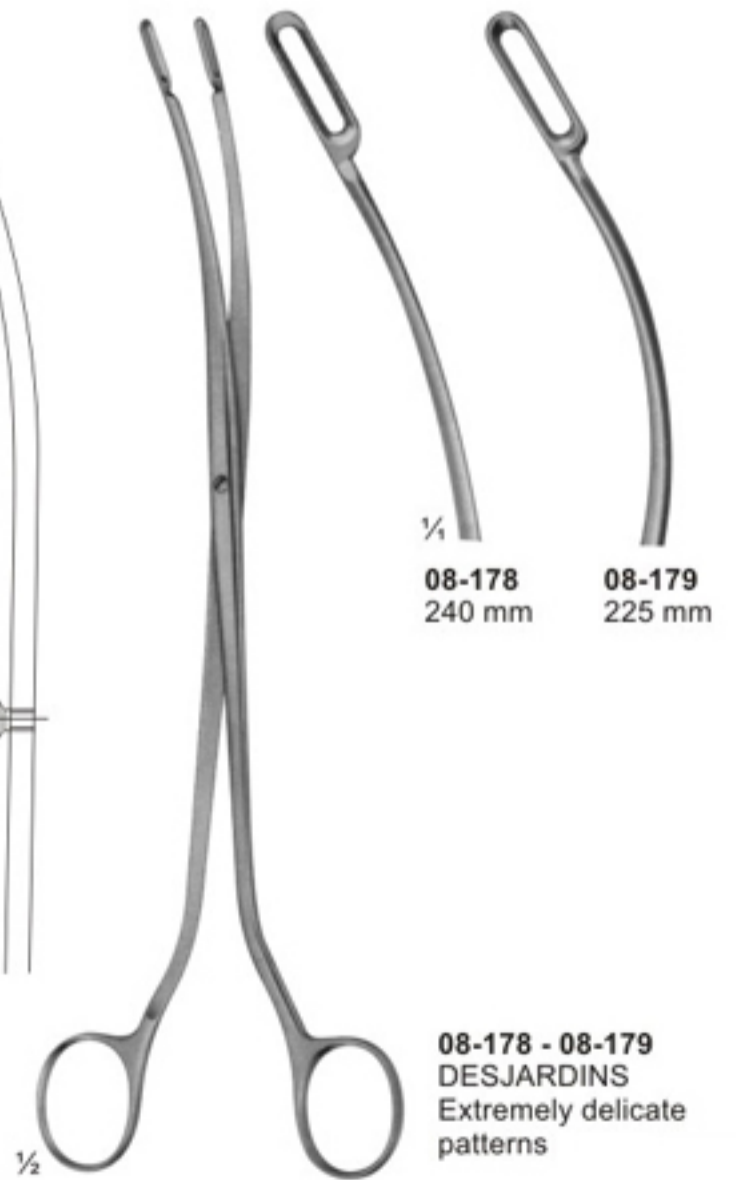
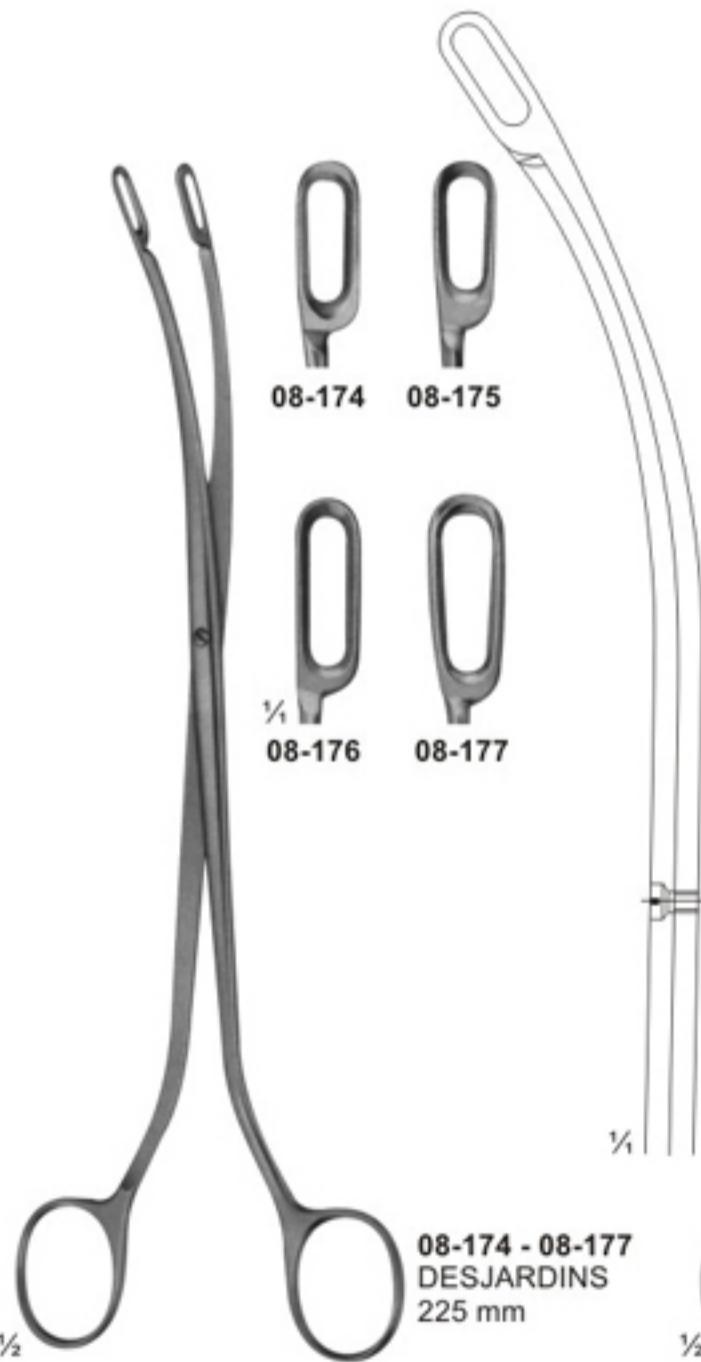
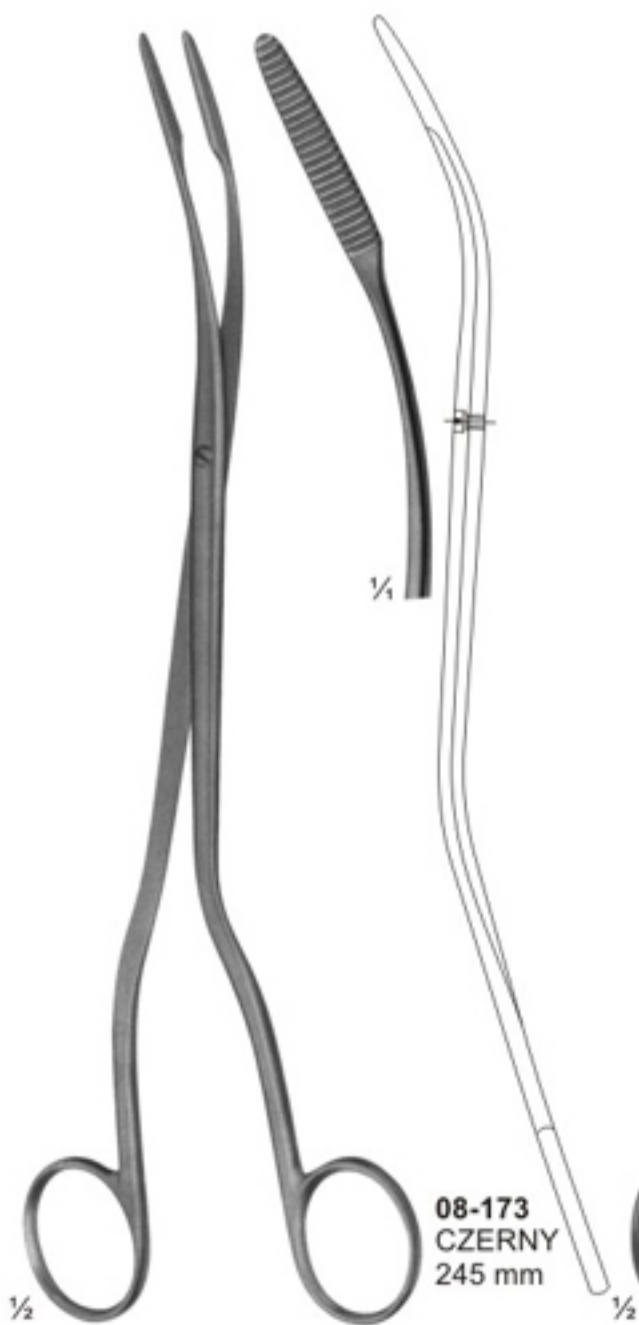
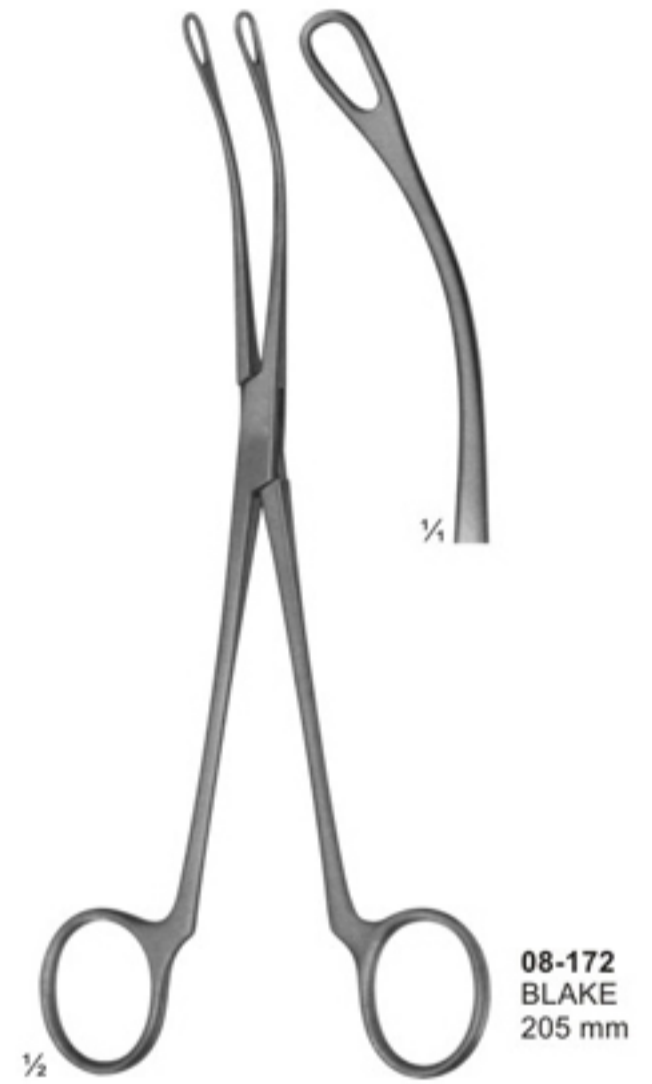

Kidney Clamps

ATRAUMATA

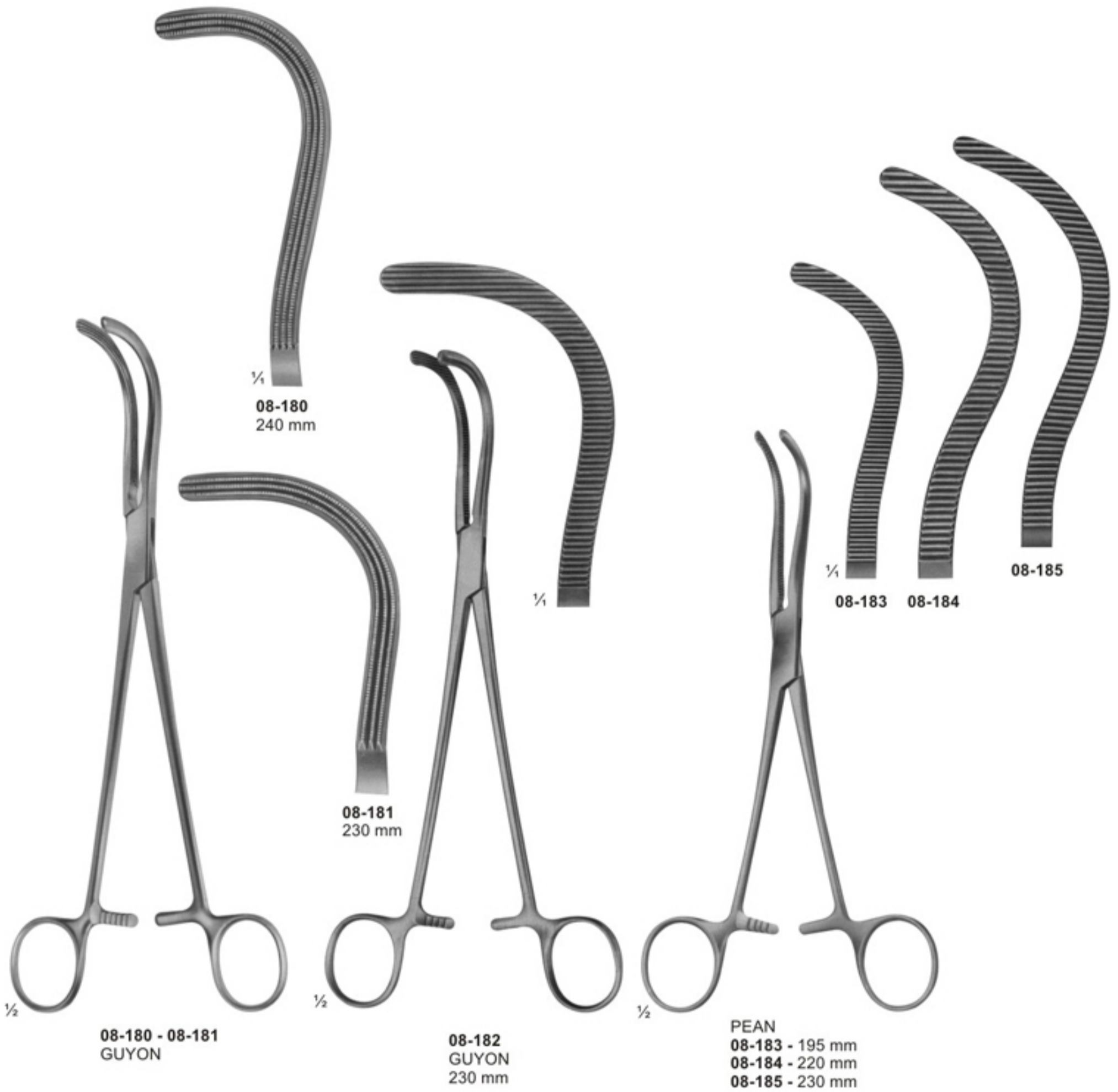

Kidney Stone Forceps



08-186



08-187



08-188



$\frac{1}{4}$
08-189



$\frac{1}{2}$

08-186 - 08-189
RANDALL
225 mm



08-190



08-191



$\frac{1}{4}$
08-192



$\frac{1}{2}$

08-190 - 08-192
RANDALL
190 mm

Bladder Retractors

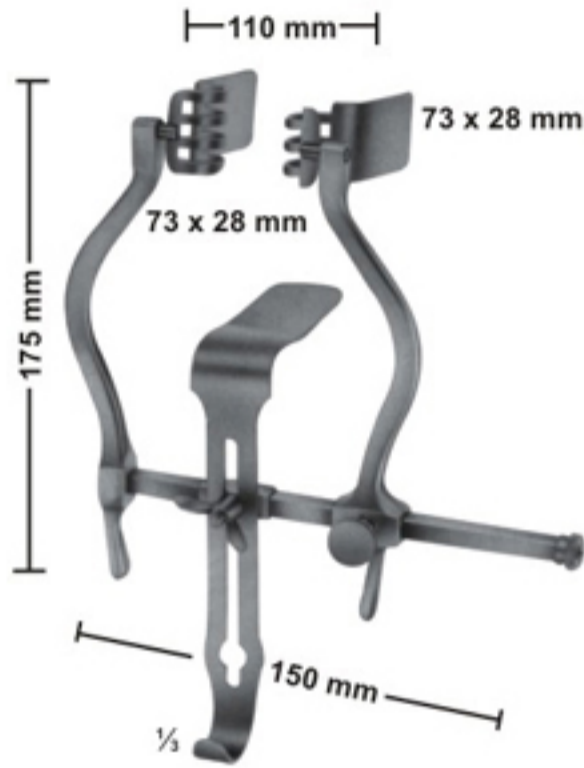

09-101
JUDD-MASSON
Bladder-and suprapubic retractor

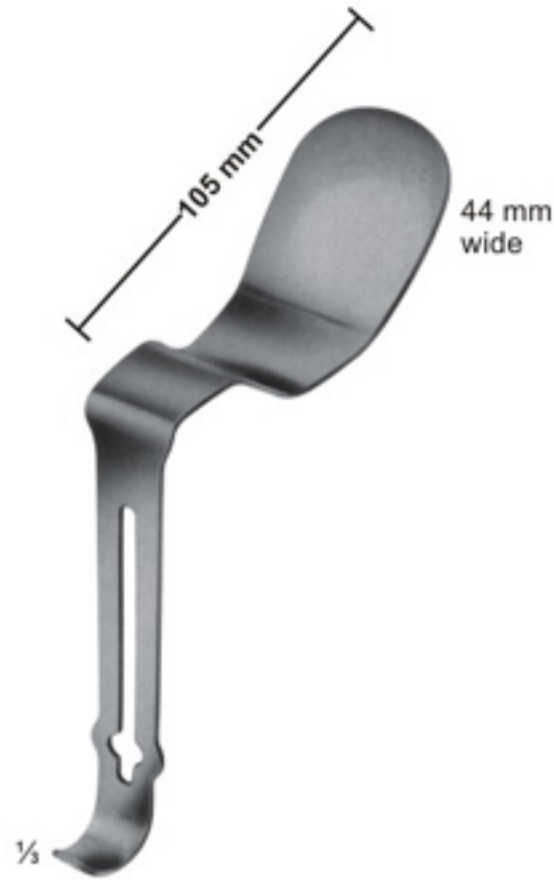

09-102
MILLIN
Center bladder for retro pubic prostatectomy



09-103
MILLIN
Bladder retractor, complete
105X45 mm



09-104
LEGUEU
Bladder retractor
Center blade
80 x 31 mm



09-105
KOCHER
Bladder spatula
235 mm

Trocars



Luer Lock

09-106
KLIMA ROSEGGER
35 X 1,8 mm
Sternal puncture needle



ϕ 6,0 mm
 ϕ 4,5 mm
 ϕ 3,3 mm
 ϕ 1,9 mm

09-107
Universal trocar
with 4 tips



80 mm

NELSON

09-108 - 112
Inside diam. Outside diam
09-108 2,2 mm 3,0 mm
09-109 3,0 mm 4,0 mm
09-110 4,0 mm 5,0 mm
09-111 5,0 mm 6,0 mm
09-112 5,5 mm 6,5 mm
for hydrocele and abdominal puncture



80 mm

09-113 - 116
Inside dime. Outside dime
09-113 2,2 mm 3,0 mm
09-114 3,0 mm 4,0 mm
09-115 4,0 mm 5,0 mm
09-116 5,0 mm 6,0 mm
for abdominal puncture,
with stop-cock and lateral drain



100 mm
110 mm

09-117 - 118
Inside diam. Outside diam
09-117 6,5 mm 8,0 mm
09-118 9,0 mm 10,0 mm
Empyema trocar
BUELEU

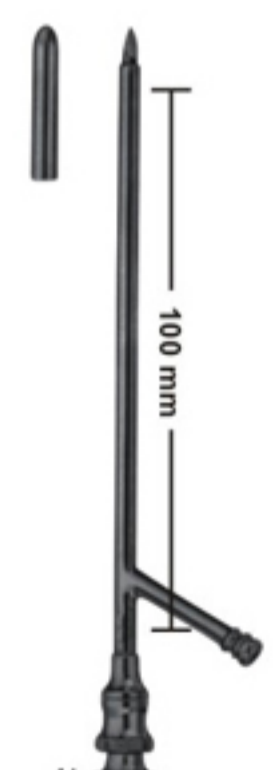

100 mm

09-119 - 122
Inside diam. Outside diam
09-119 3,0 mm 4,0 mm
09-120 3,6 mm 4,6 mm
09-121 4,3 mm 5,3 mm
09-122 5,0 mm 6,0 mm
Gall bladder trocars. OCHSNER



Record Cone1

09-123
PIERCE
Antrum trocar
 ϕ 4,0 mm



Luer - Lock
Cone

09-124
COAKLEY
Antrum trocar
3,0 mm

Vaginal Specula

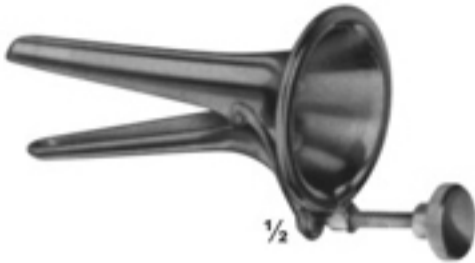

10-101
COLLIN
for children
53 x 10 mm

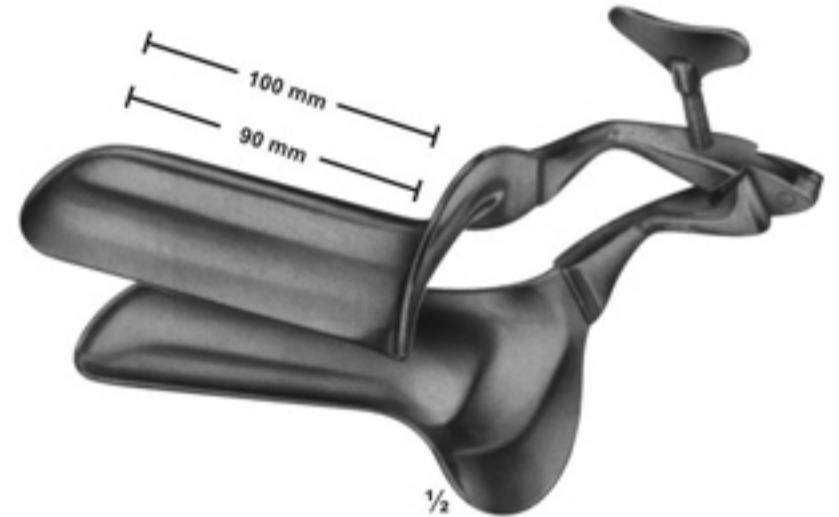

10-102 - 105
COLLIN

10-102	100/90mm	28 mm
10-103	100/90mm	32 mm
10-104	105/95mm	35 mm
10-105	115/105mm	40 mm
Total length/working length		width



10-106
COLLIN
for virgins
95/85 x 18 mm



10-107
CUSCO
for virgins
75 x 17 mm



10-108
CUSCO
for virgins
75 x 17 mm

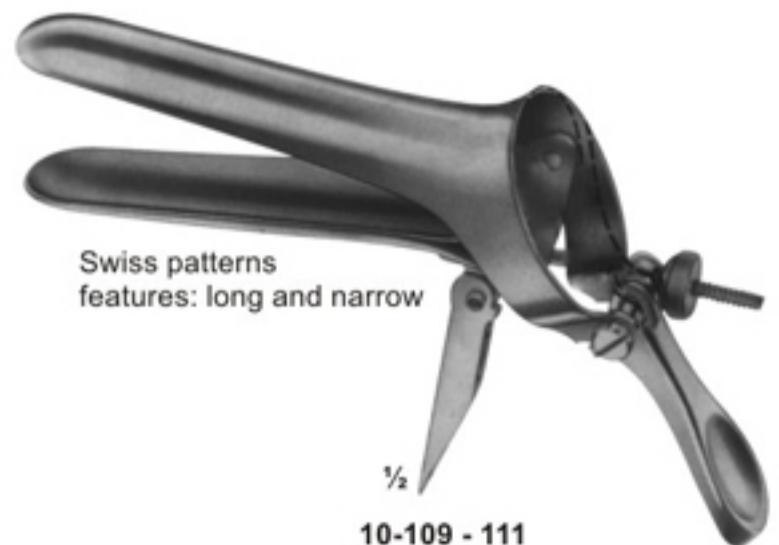

10-109 - 111
CUSCO

10-109	92X23-25 mm
10-110	100x25-27 mm
10-111	110x27-30 mm

Vaginal Specula- Sets, upper and lower blades



Vaginal Specula- upper and lower blades



10-127 - 131
KRISTELLER
10-127 110X18 mm
10-128 110X20 mm
10-129 110X27 mm
10-130 110X30 mm
10-131 110X36 mm
220 mm

10-132 - 10-135
KRISTELLER
Upper blades

10-136 - 10-139
KRISTELLER
Lower blades

Vaginal Specula



10-140
60 X 45 mm

10-141
90 X 45 mm

10-142
112 X 45 mm

10-140 - 143
DOYEN
235 mm

length of blades
60 mm
90 mm
120 mm
160 mm

width of blades
35 mm 45 mm 60 mm

width of blades
35 mm 45 mm 60 mm
10-143 **10-146** **10-150**
10-144 **10-147** **10-151**
10-145 **10-148** **10-152**
 10-149 **10-153**

10-143 - 10-153
DOYEN
240 mm

Vaginal Retractors



10-154
JOLL (FRIEDMAN)
155 mm



10-155
RICHTER
170 mm



10-156
GELPI
135 mm



10-157
GELPI
175 mm

Uterine Dilators



11-101 - 143
HEGAR
with very conical point
185 mm

11-101	1	mm	11-123	23	mm
11-102	2	mm	11-124	24	mm
11-103	3	mm	11-125	25	mm
11-104	4	mm	11-126	26	mm
11-105	5	mm	11-127	1	½mm
11-106	6	mm	11-128	2	½mm
11-107	7	mm	11-129	3	½mm
11-108	8	mm	11-130	4	½mm
11-109	9	mm	11-131	5	½mm
11-110	10	mm	11-132	6	½mm
11-111	11	mm	11-133	7	½mm
11-112	12	mm	11-134	8	½mm
11-113	13	mm	11-135	9	½mm
11-114	14	mm	11-136	10	½mm
11-115	15	mm	11-137	11	½mm
11-116	16	mm	11-138	12	½mm
11-117	17	mm	11-139	13	½mm
11-118	18	mm	11-140	14	½mm
11-119	19	mm	11-141	15	½mm
11-120	20	mm	11-142	16	½mm
11-121	21	mm	11-143	17	½mm
11-122	22	mm			



11-144 - 152
HEGAR
205 mm

11-144	1+2	mm
11-145	3+4	mm
11-146	5+6	mm
11-147	7+8	mm
11-148	9+10	mm
11-149	11+12	mm
11-150	13+14	mm
11-151	15+16	mm
11-152	17+18	mm

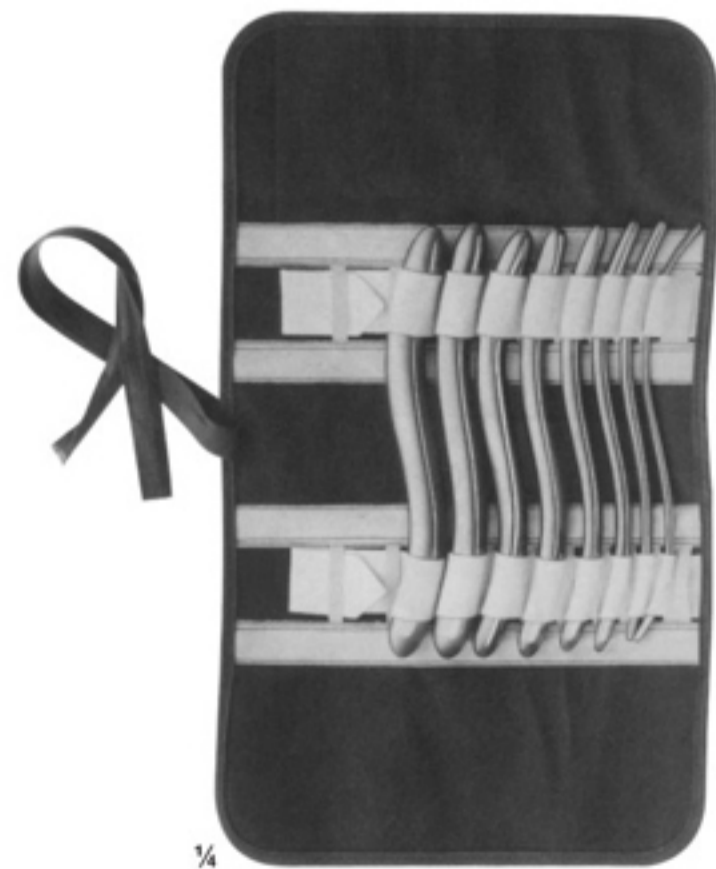

11-153
HEGAR
Uterine dilator set, in canvas
roll with 8 dilators.

Uterine Probes

5 mm



11-154
MAYO
malleable
330 mm

4 mm



11-155
SIMS
malleable
330 mm

3 mm



11-156
MARTIN
330 mm

4 mm



11-157
SIMPSON
malleable
silver-plated
290 mm



24 mm

11-158
BRAUN
Uterine
depressor
270 mm



1/4

11-159
Cotton
applicator
270 mm

Uterine Dressing Forceps



11-160
PELKMAN
260 mm



11-161
PELKMAN
260 mm



11-162
BOZEMANN
250 mm



11-163
BOZEMANN
255 mm

Jaws with longitudinal groove

Polypus-and Ovum Forceps

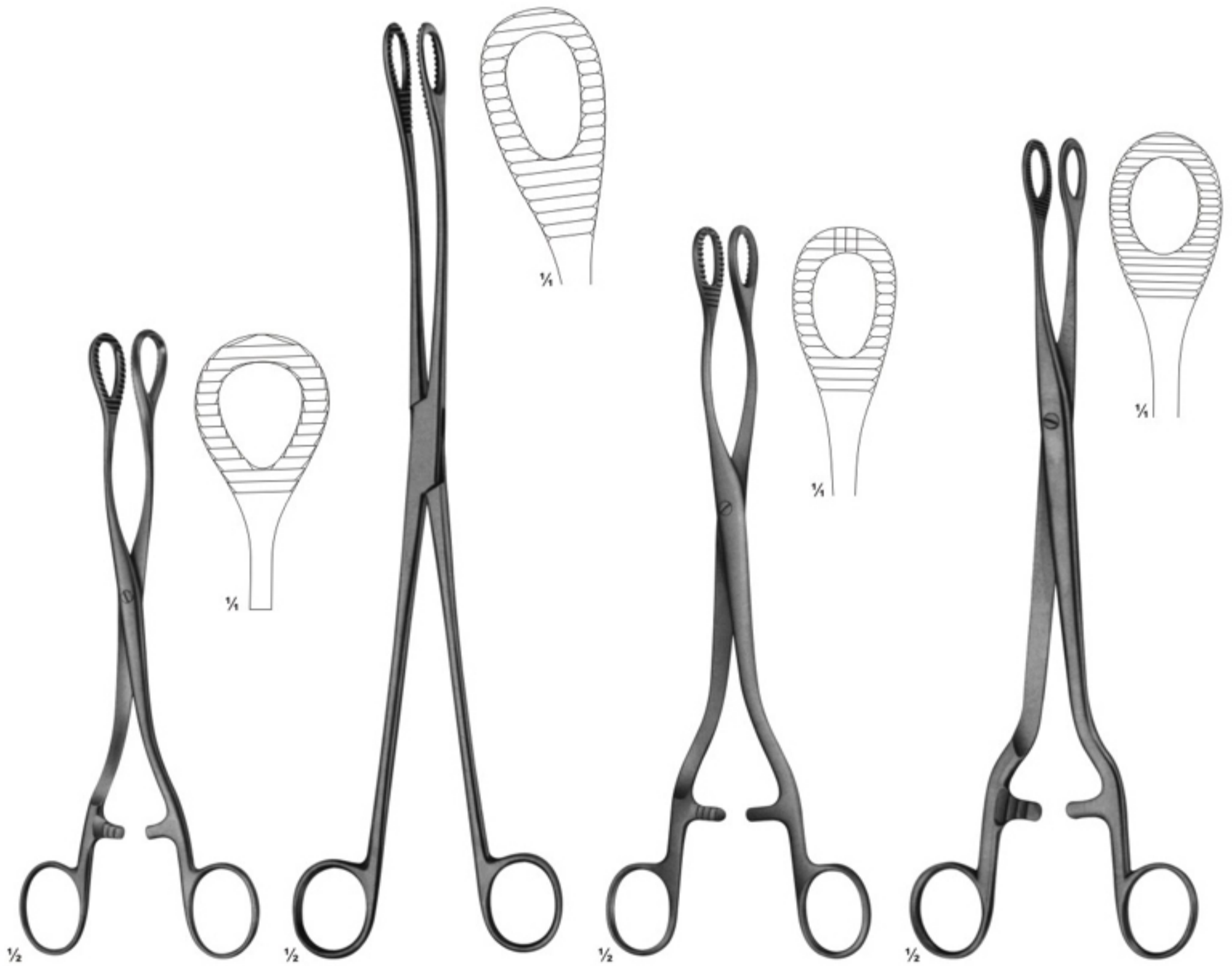

11-164
HEYWOOD-SMITH
200 mm

11-165
KELLY
320 mm

11-166
HEYWOOD-SMITH
250 mm

11-167
NOTO
280 mm

Ear Currettes



12-101
Langenbeck
13 cm / 5 1/8"

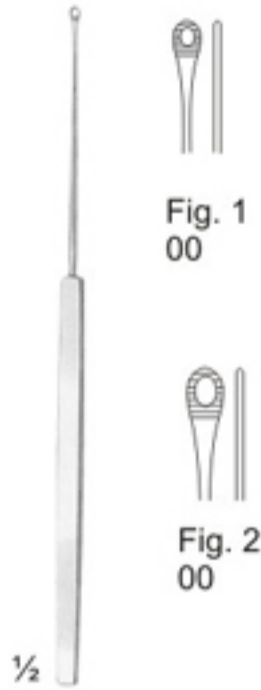

12-102
Shapleigh
15 cm / 5 1/8"

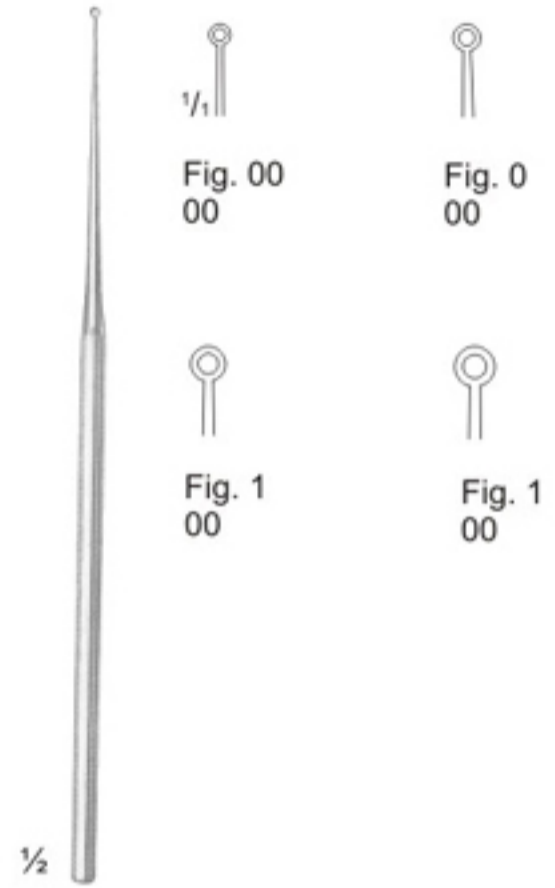

12-103
Buck
17cm / 6 6/8"

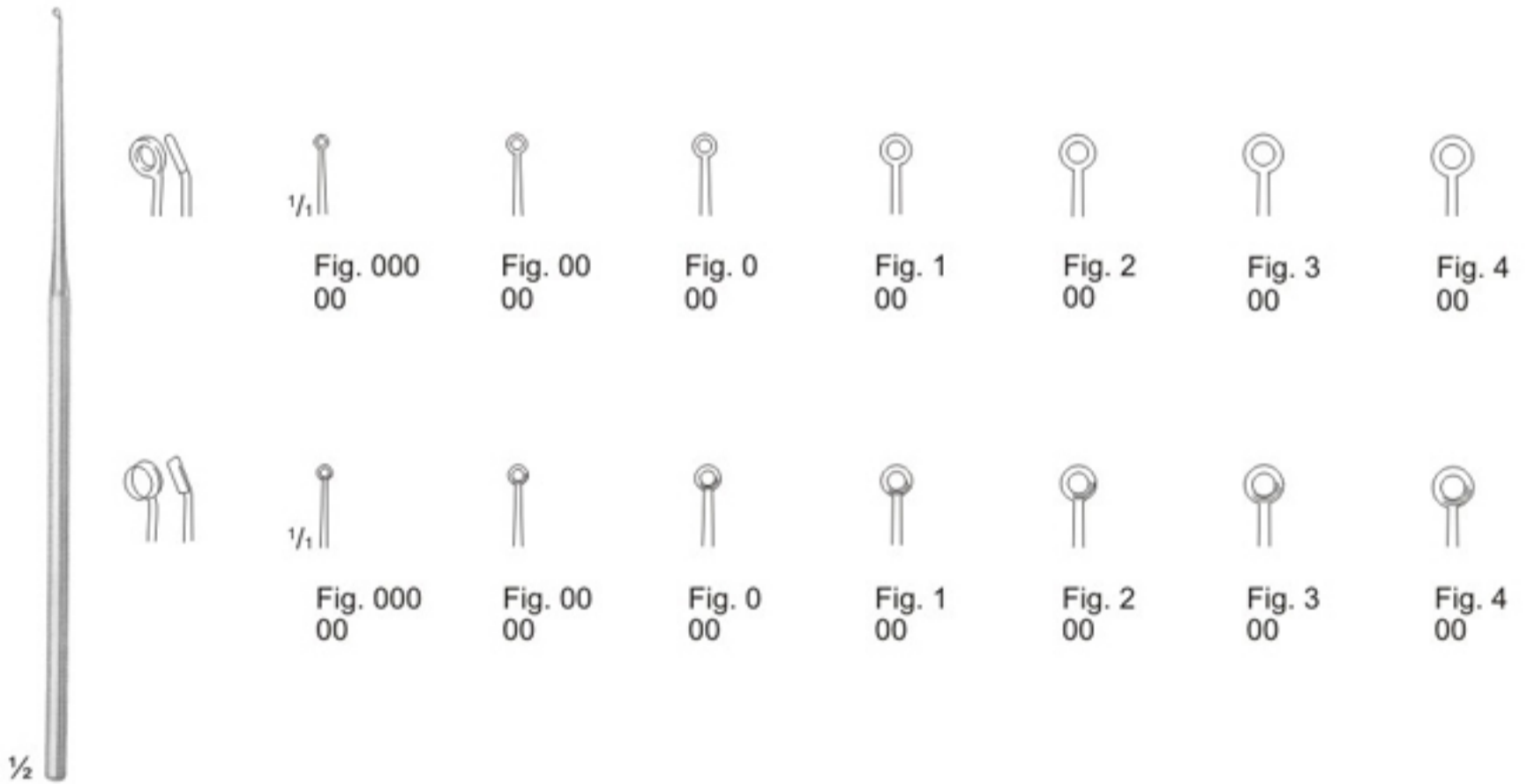

12-104
Buck
15 cm / 6 6/8"

Biopsy Curettes

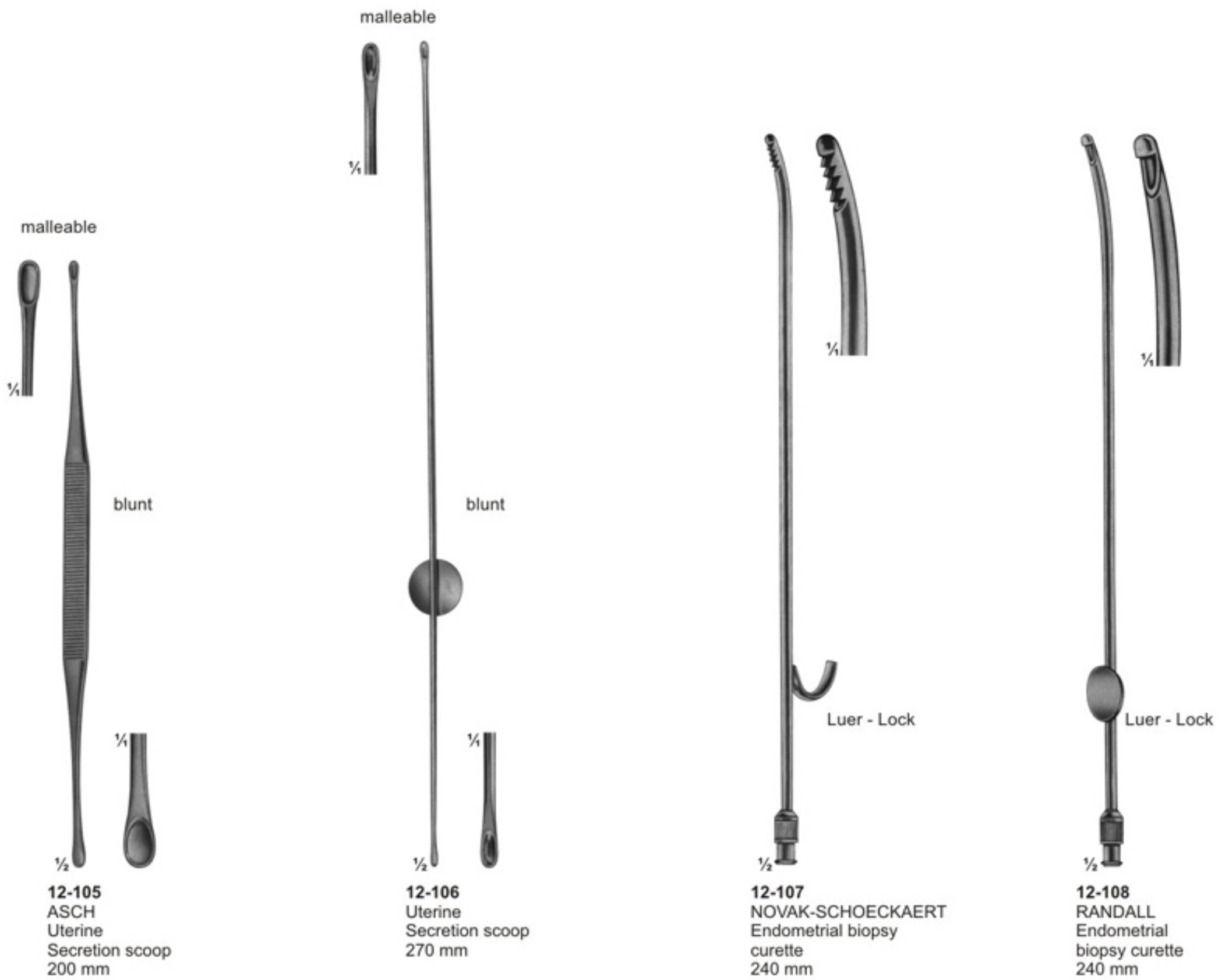

Ear Polypus Forceps



12-109
Hartmann-Wullstein
shaft length
85 mm

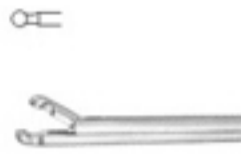

12-110
Hartmann-Wullstein
shaft length
85 mm



12-111
Hartmann
shaft length
85 mm



12-112
Hartmann
shaft length
85 mm



$\frac{1}{2}$
12-109 - 12-119

12-113
14 cm / 5 4/8"
shaft length
140 mm



$\frac{1}{3}$
12-114
Hartmann-Herzfeil
2,0 mm
shaft length
85mm



12-115
Hartmann
3 mm
shaft length
85mm

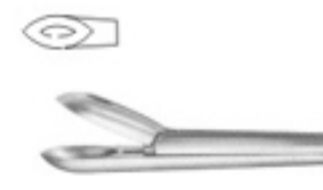

12-116
shaft length
85mm

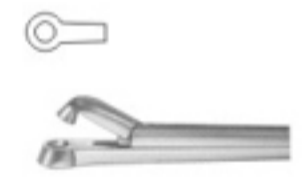

12-117
Hartmann-Hoffmar
2,0 mm
85mm

12-118
2,5 mm
85 mm

12-119
3,0 mm
85 mm

Biopsy forceps for rectum

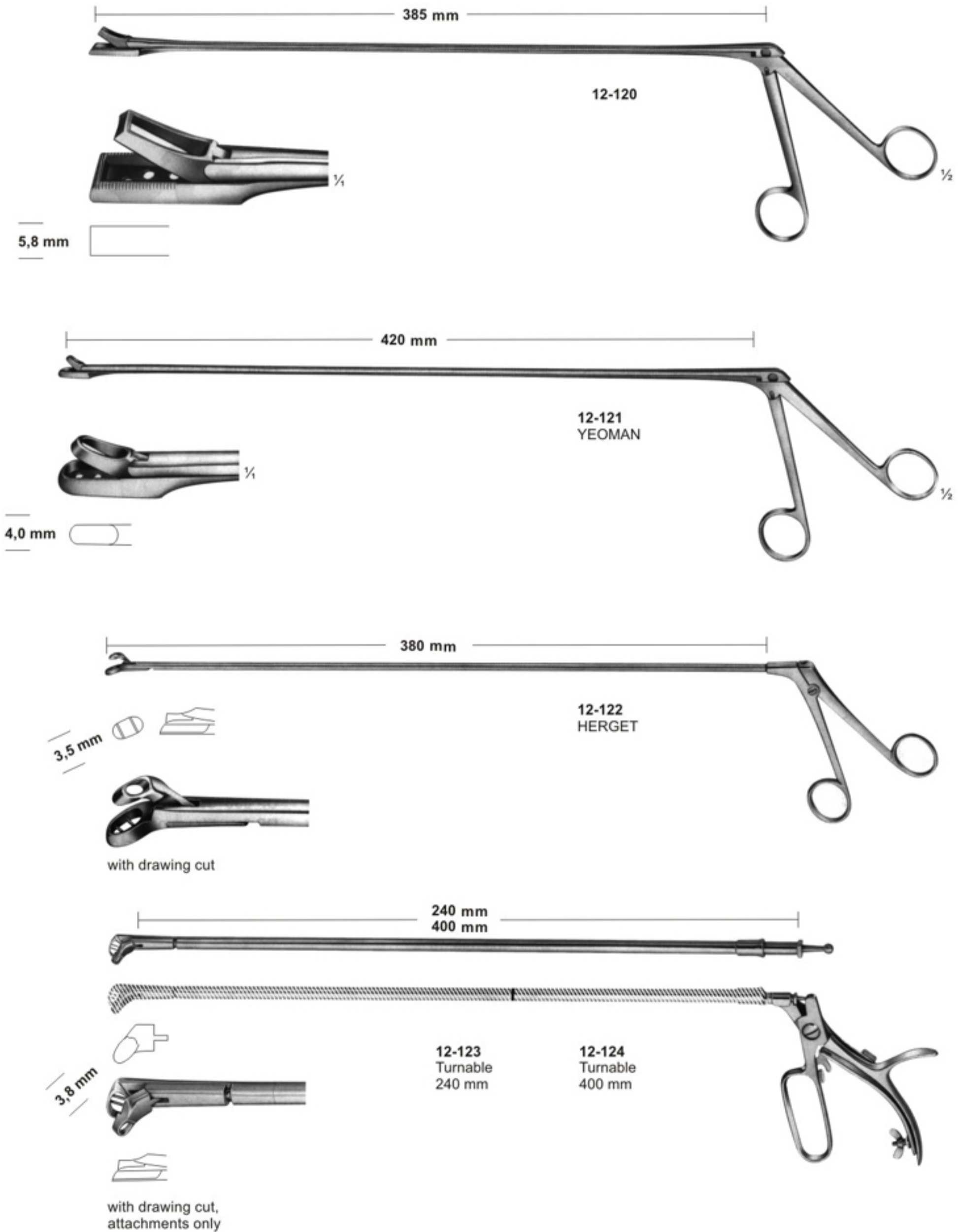

Biopsy Forceps

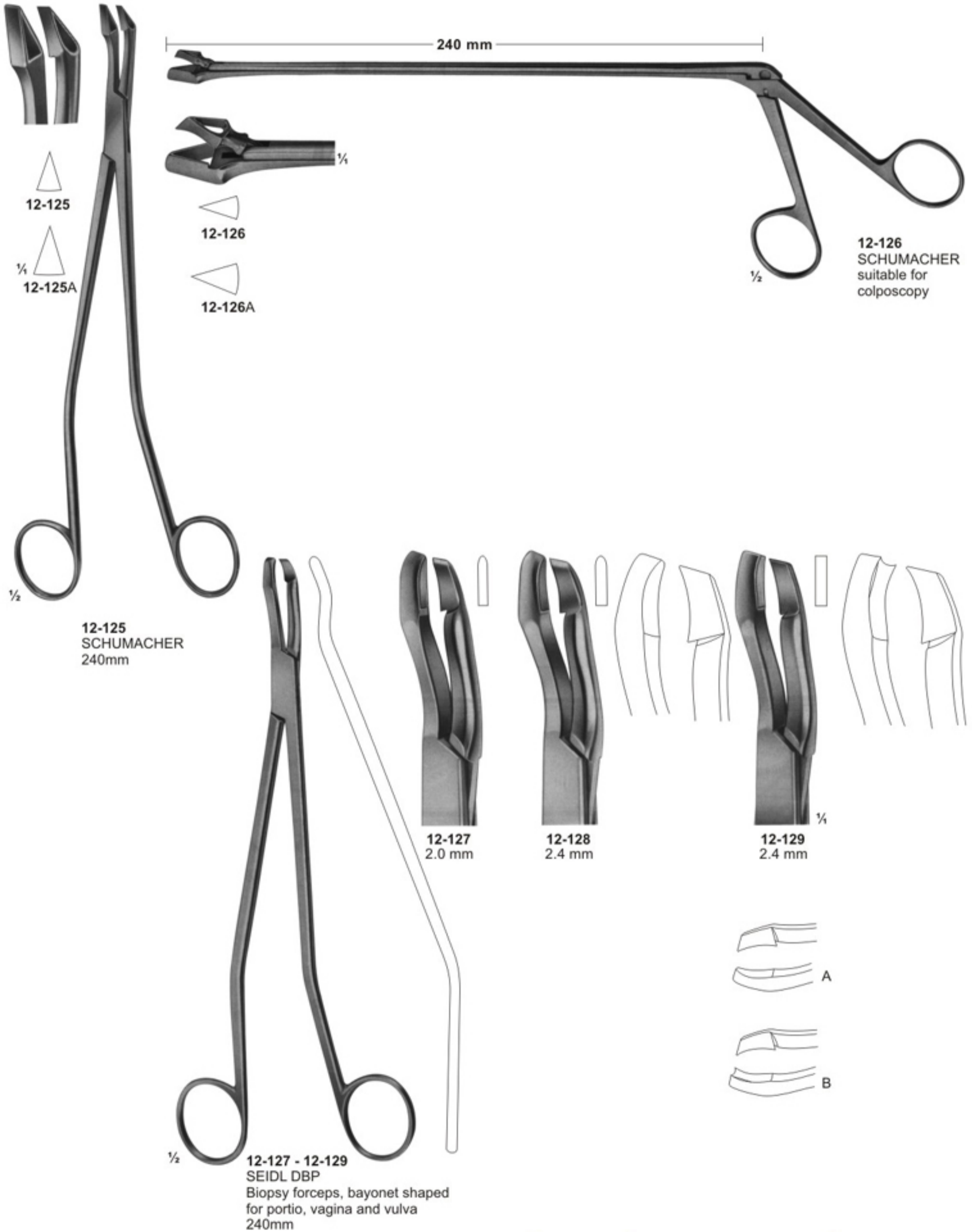

Biopsy Forceps

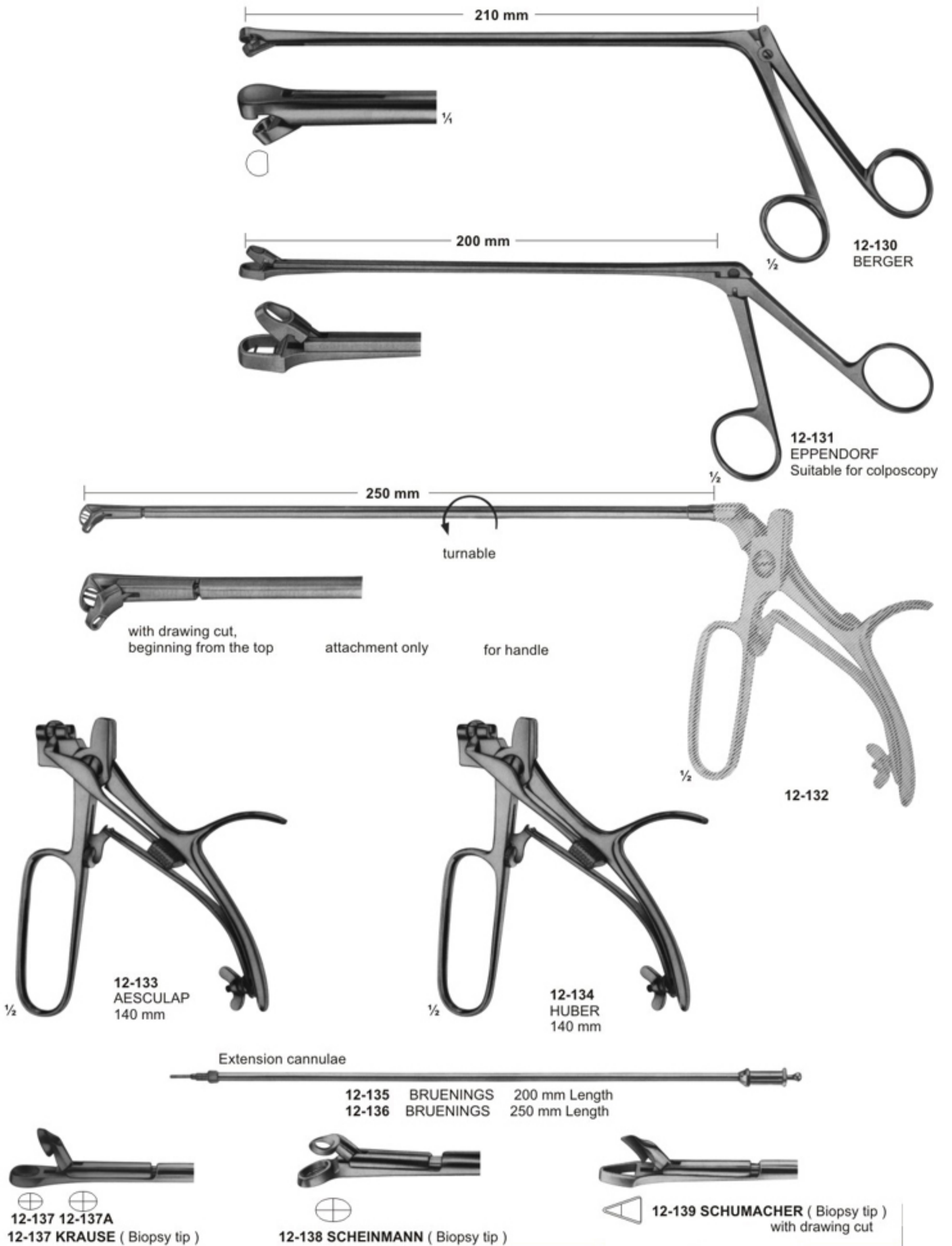

Uterine Scoops

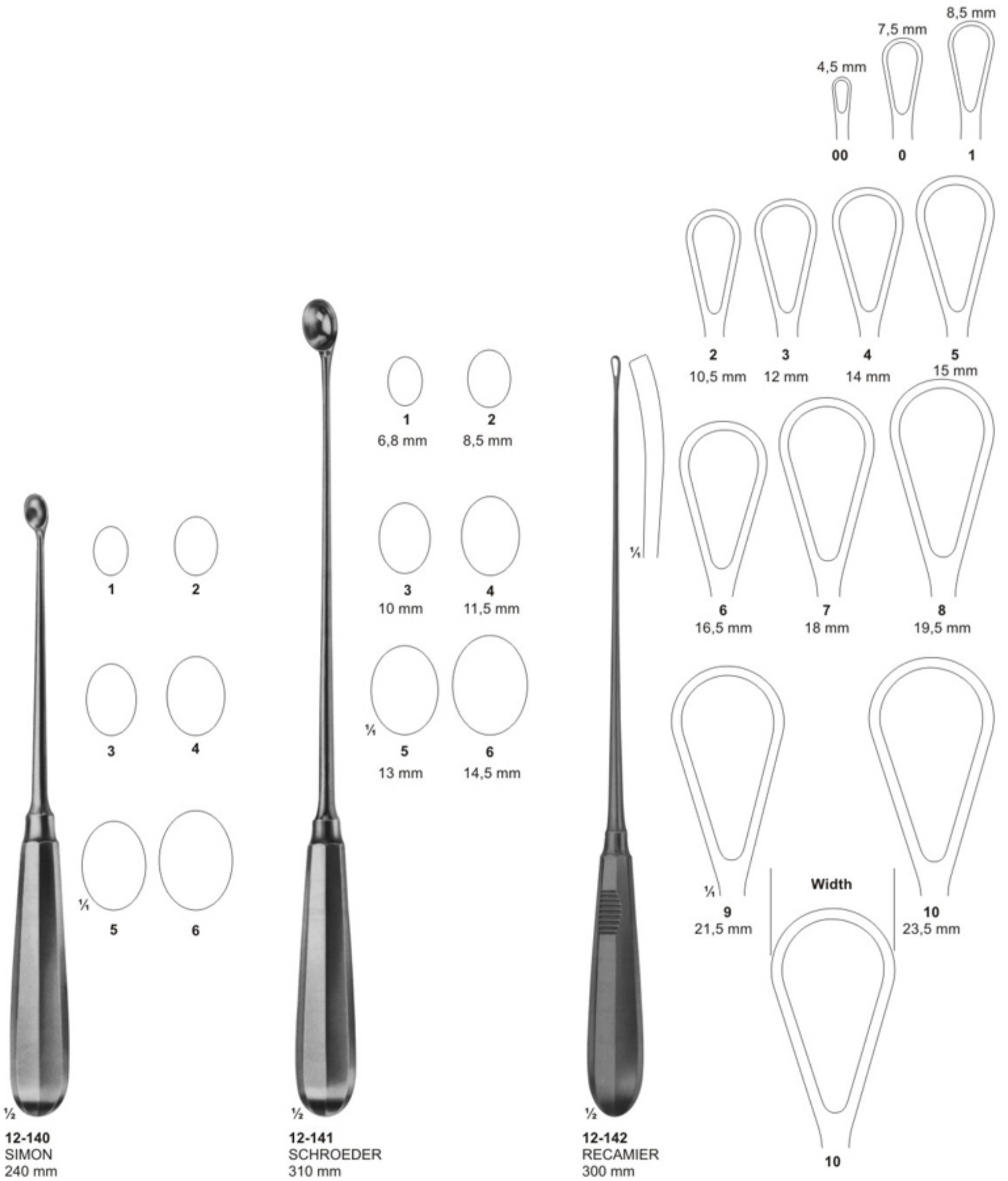

1/2
12-140
SIMON
240 mm

1/2
12-141
SCHROEDER
310 mm

1/2
12-142
RECAMIER
300 mm

Obstetrical Forceps



13-101
NAEGELE
355 mm



13-102
NAEGELE
400 mm



13-103
SIMPSON-BRAUN
305mm

Obstetrics- Placenta and Ovum Forceps

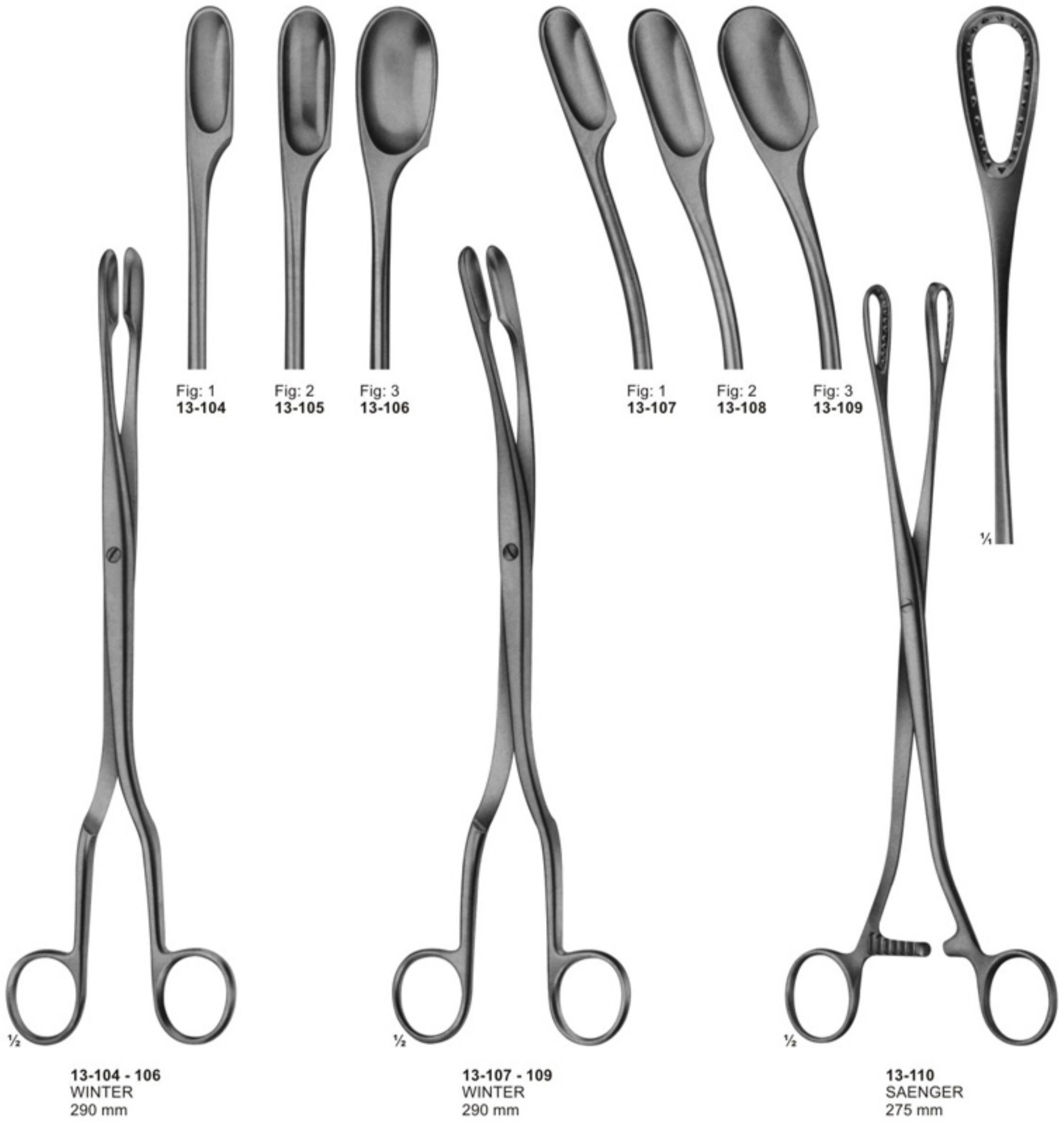

Tongue and Tracheal Hooks and Dilators

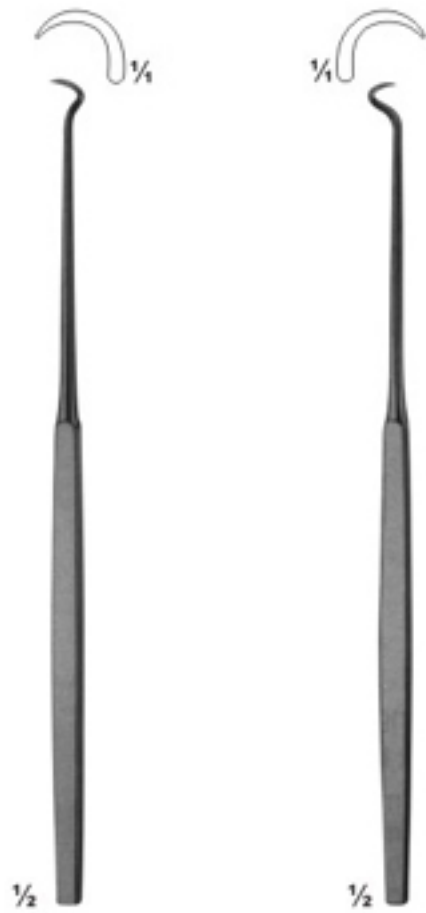

13-111
BOSE
165 mm



13-112
BOSE
165 mm



13-113 - 115
180 mm



13-113
sharp



13-114
blunt



13-115
stumpf/blunt



13-116
FINSEN
50 mm



13-117
FINSEN
70 mm



13-118
TROUSSEAU
120 mm



13-119
LABORDE
125 mm



13-120
LABORDE
strong pattern
135 mm



13-121
Cleaning Brush
for tracheal tubes
285 mm

Vascular Spatulas

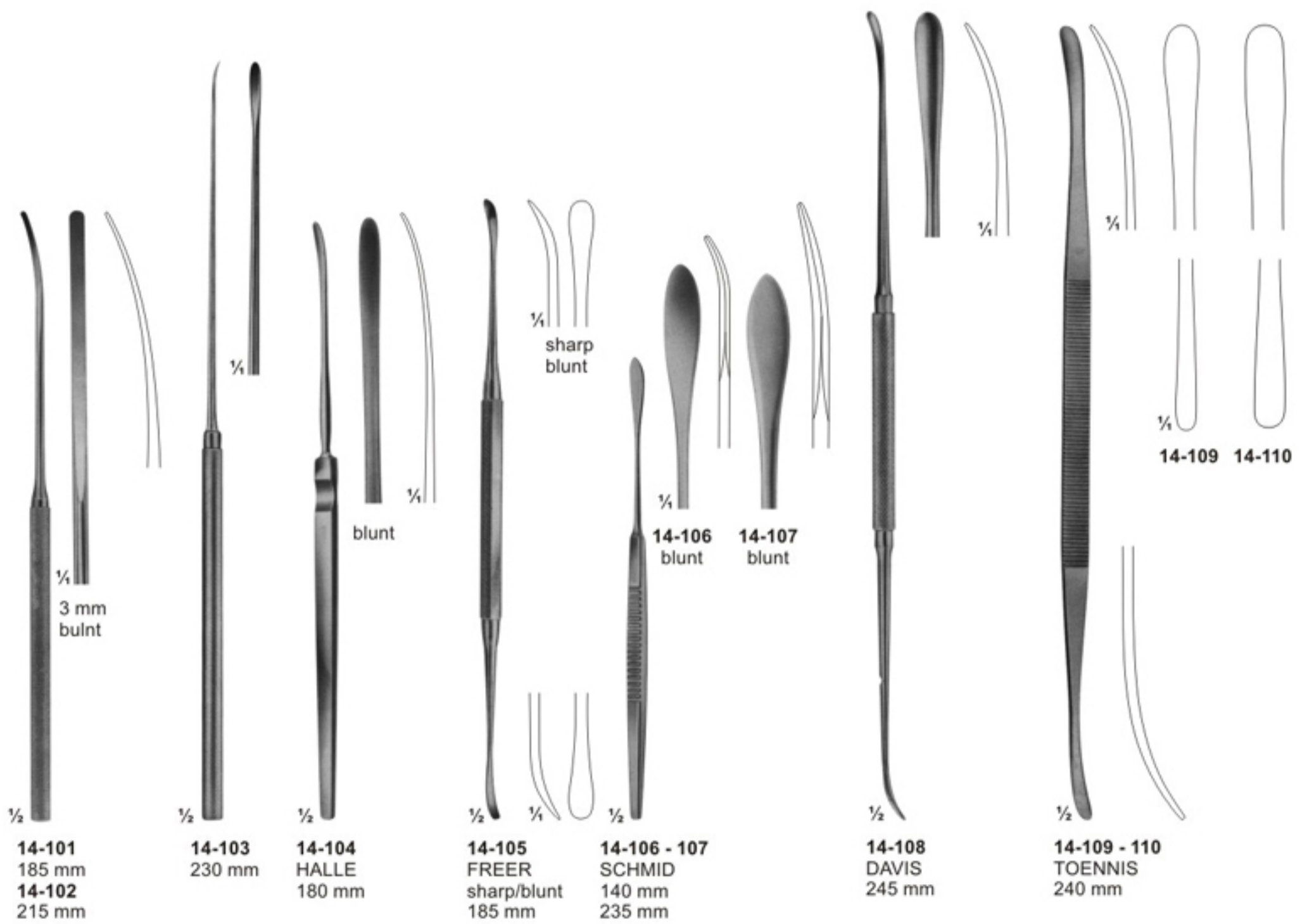

ATRAUMATA Forceps

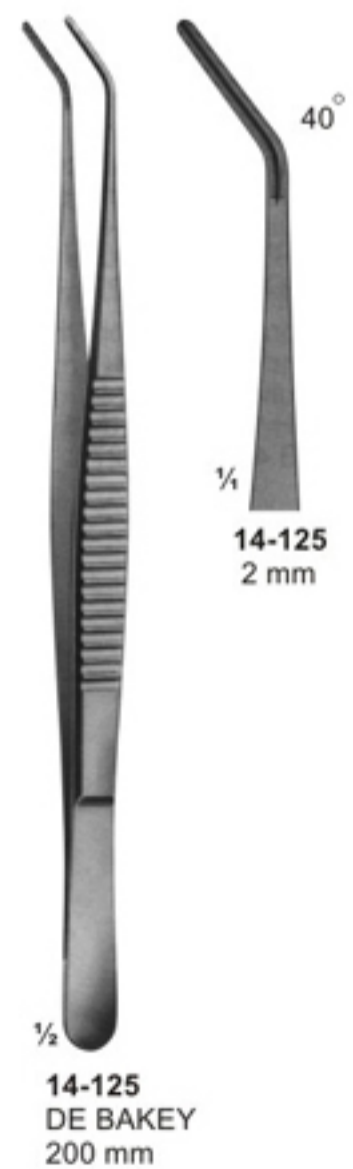
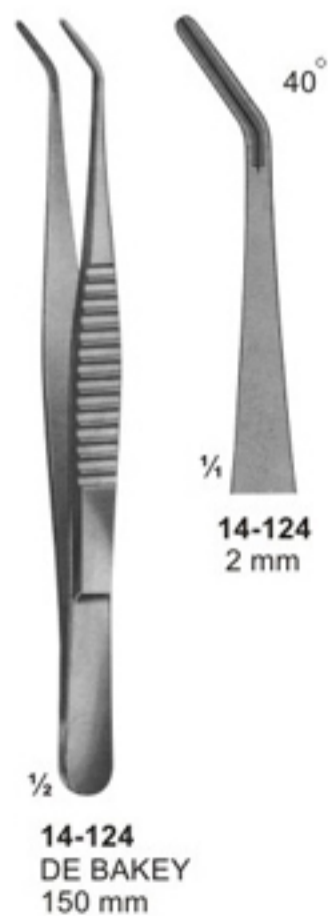
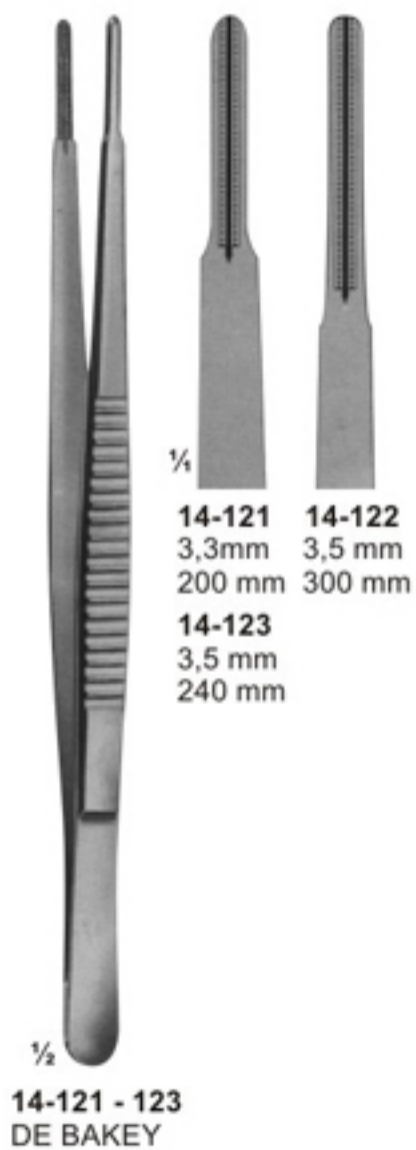
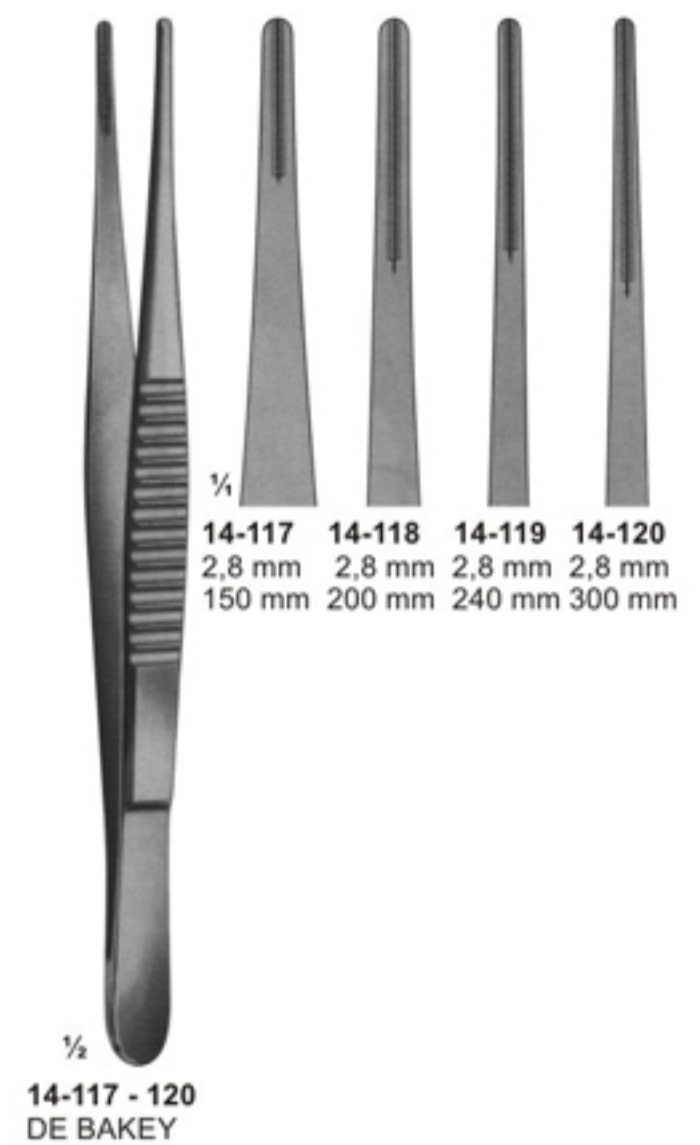
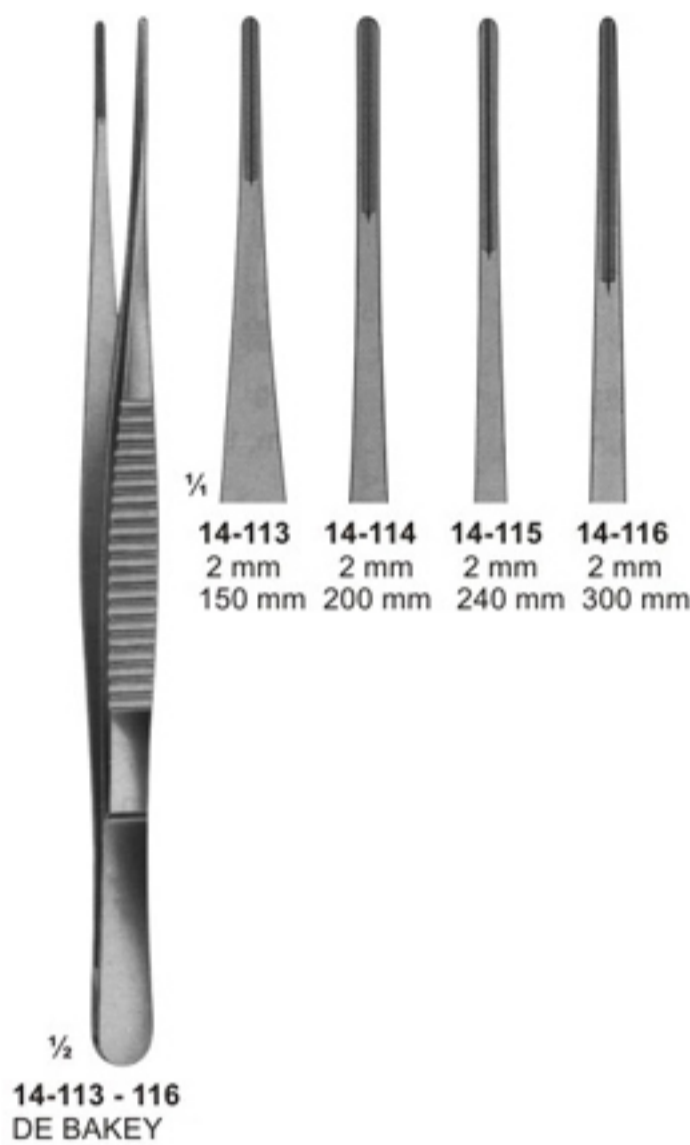
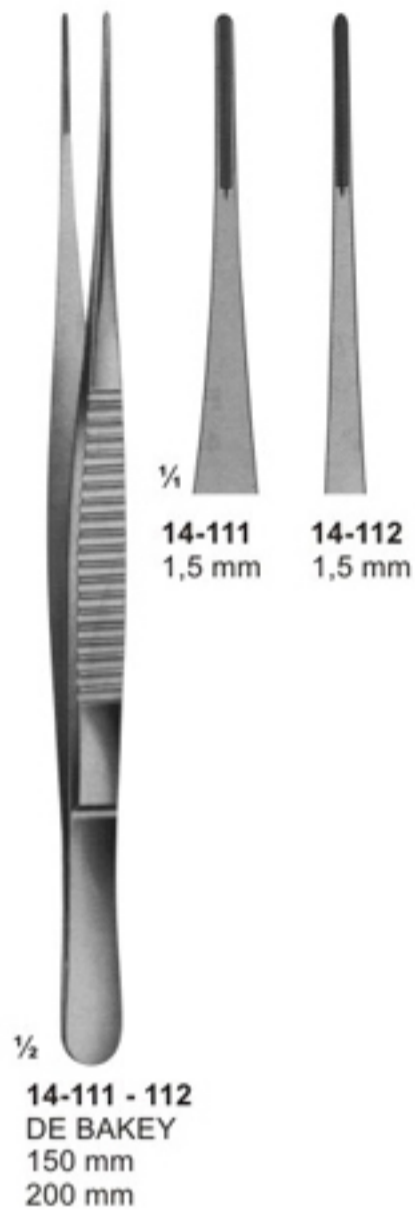

ATRAUMATA

Anastomosis- and Multi- Purpose- Clamps- Pediatric types

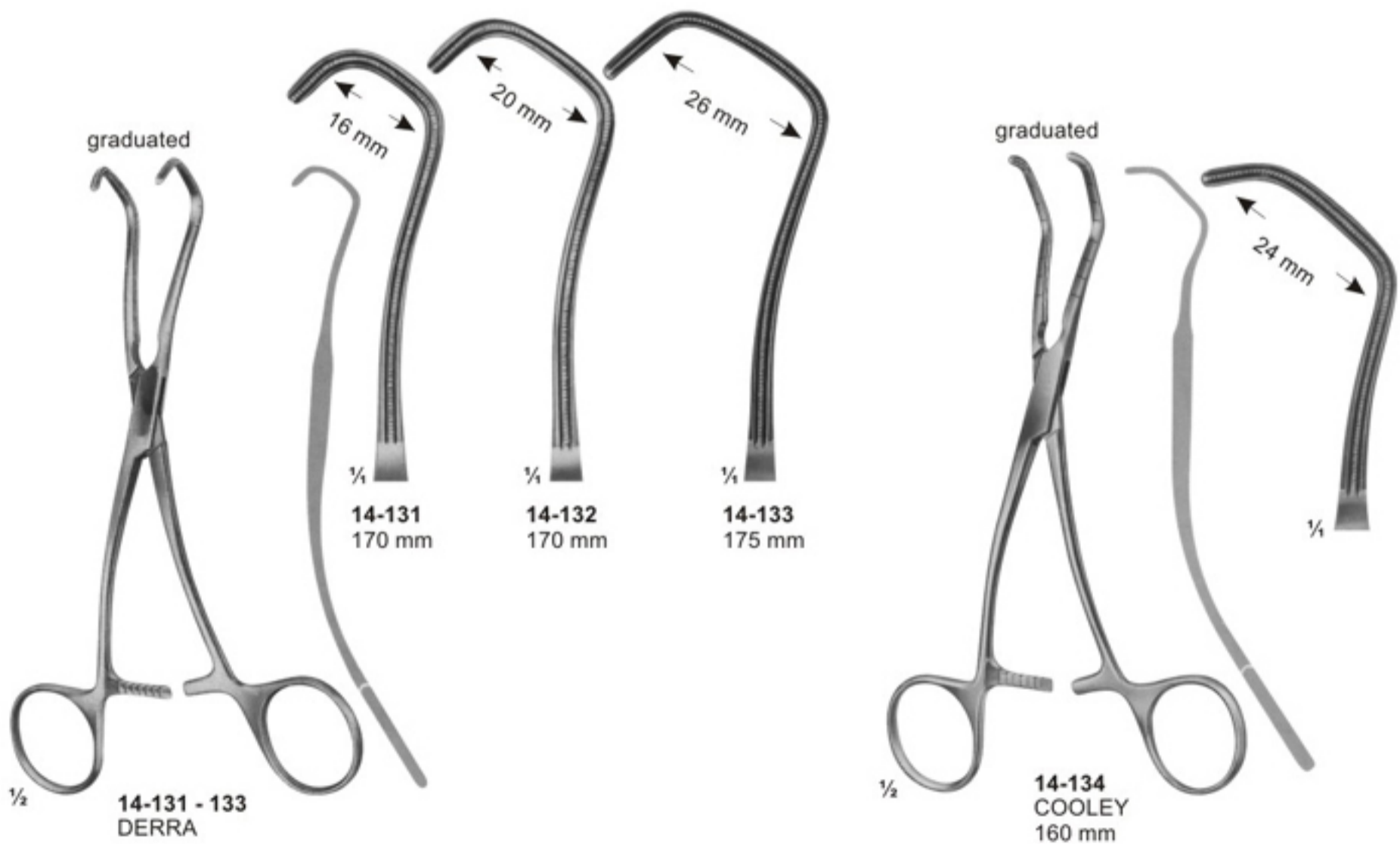
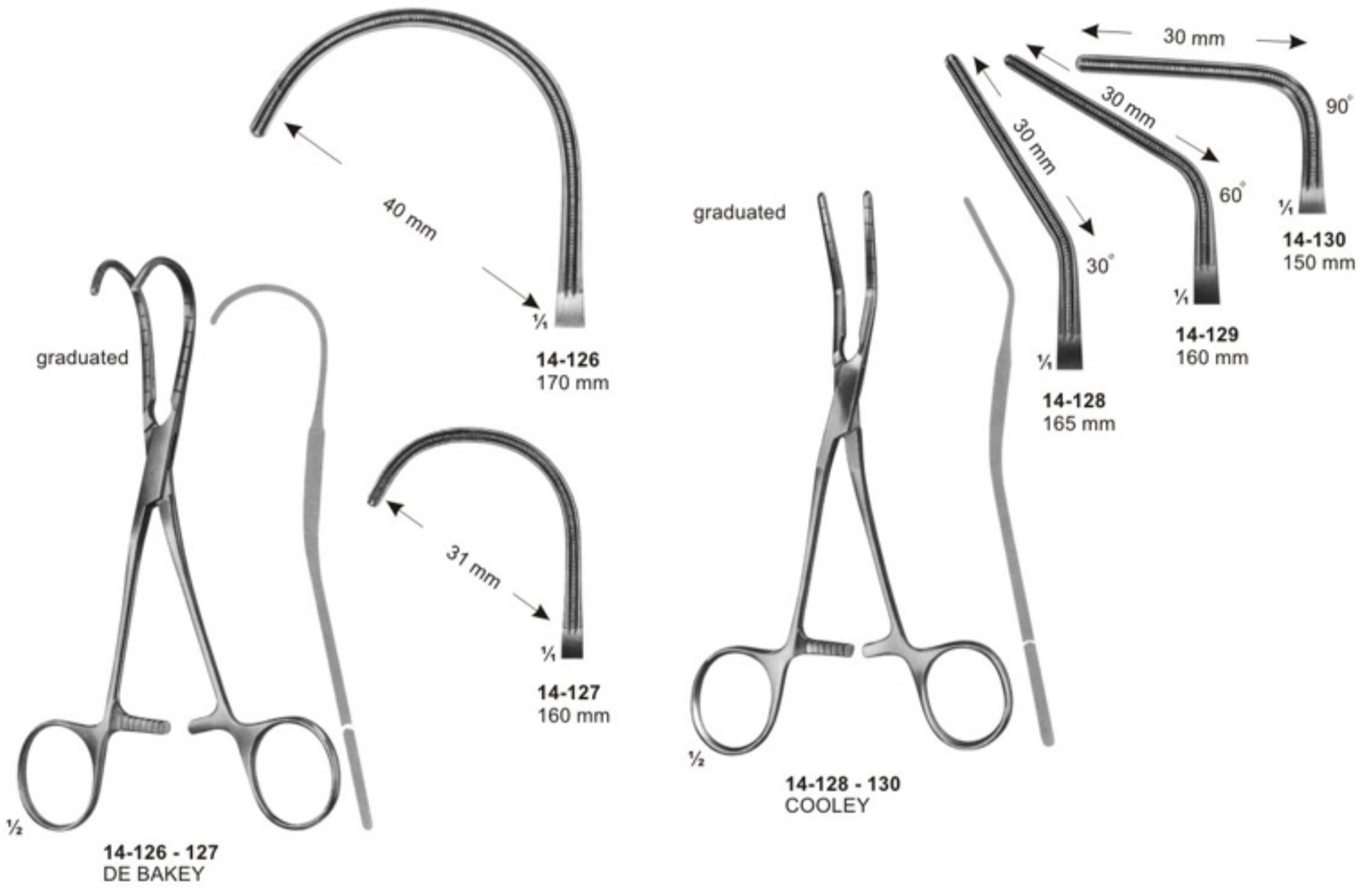

ATRAUMATA
Coarctation Clamps, Patent-Ductus & Peripheral-Vascular Clamps

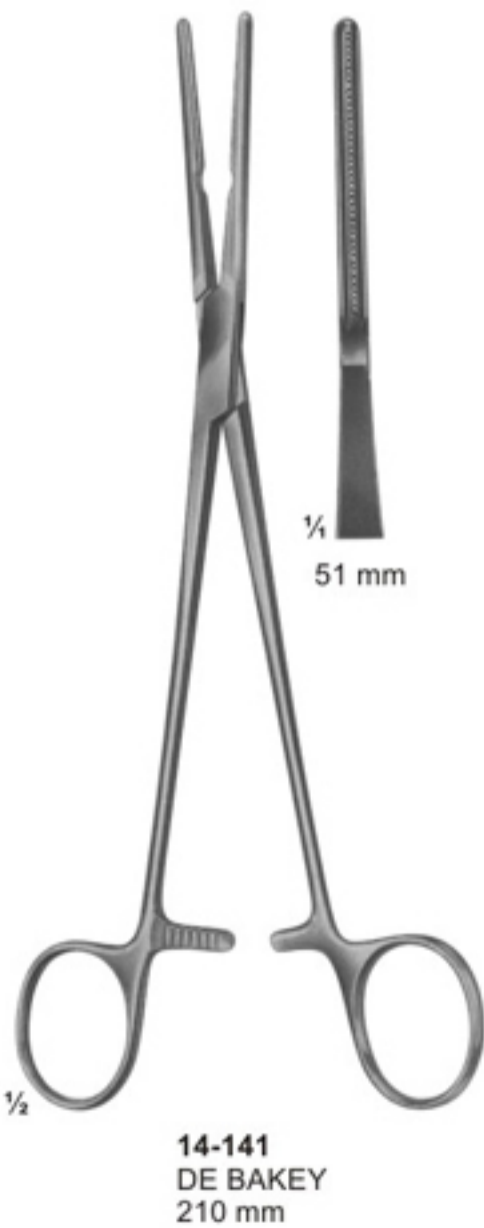
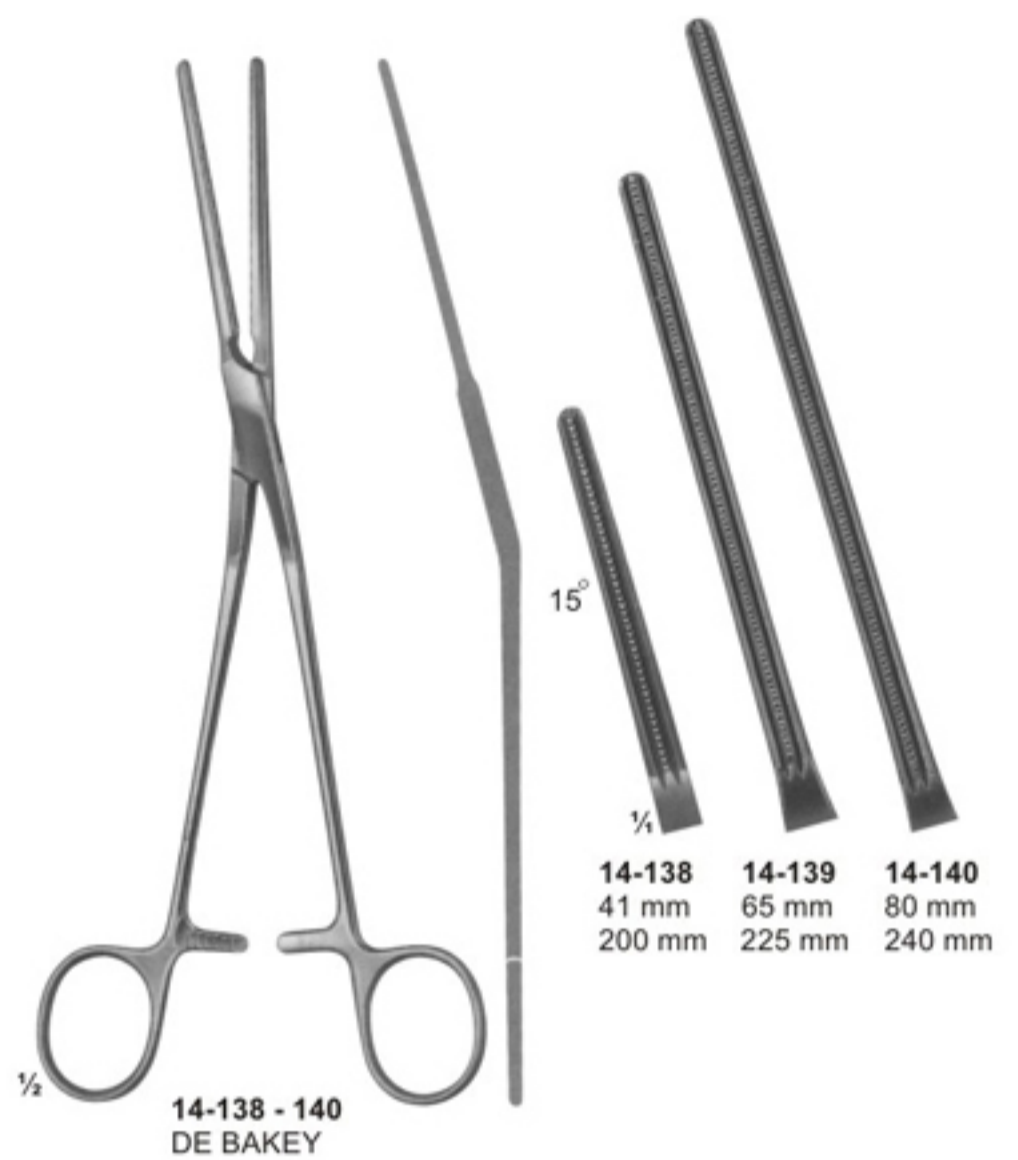

Aorta- Anastomosis Clamps

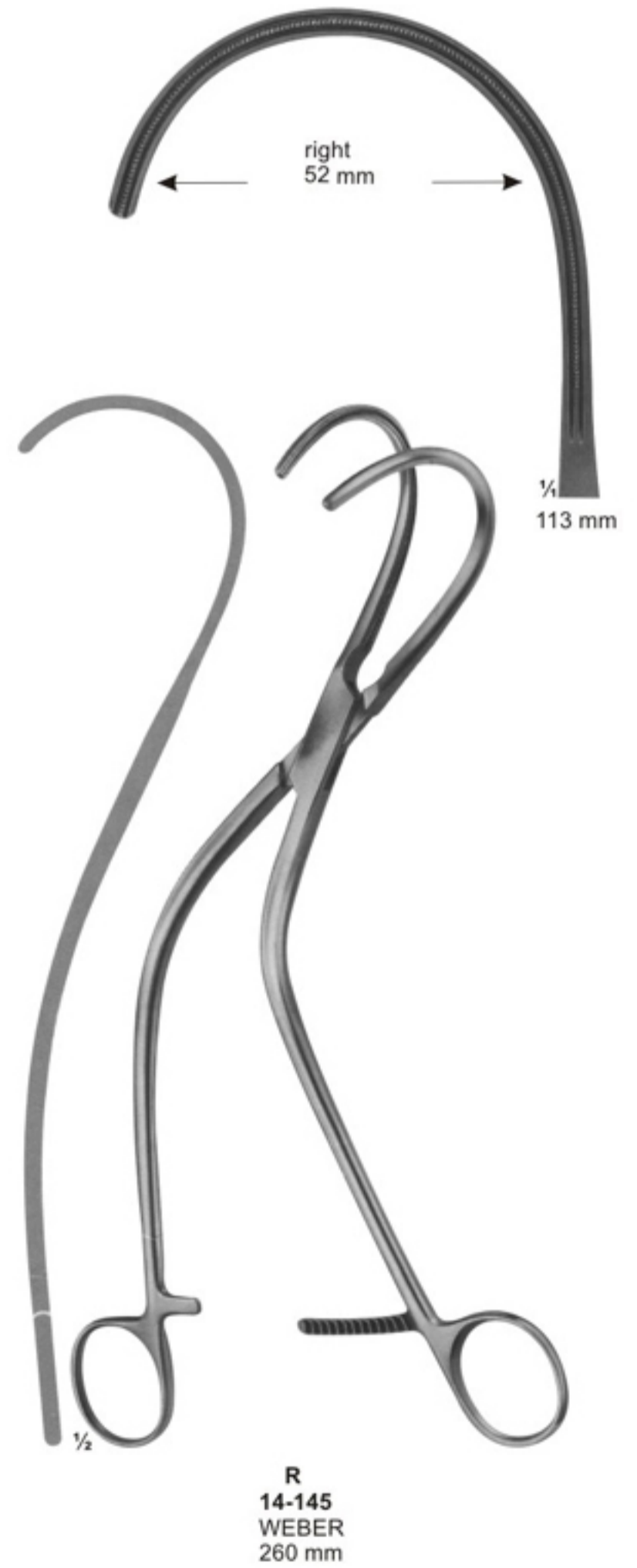
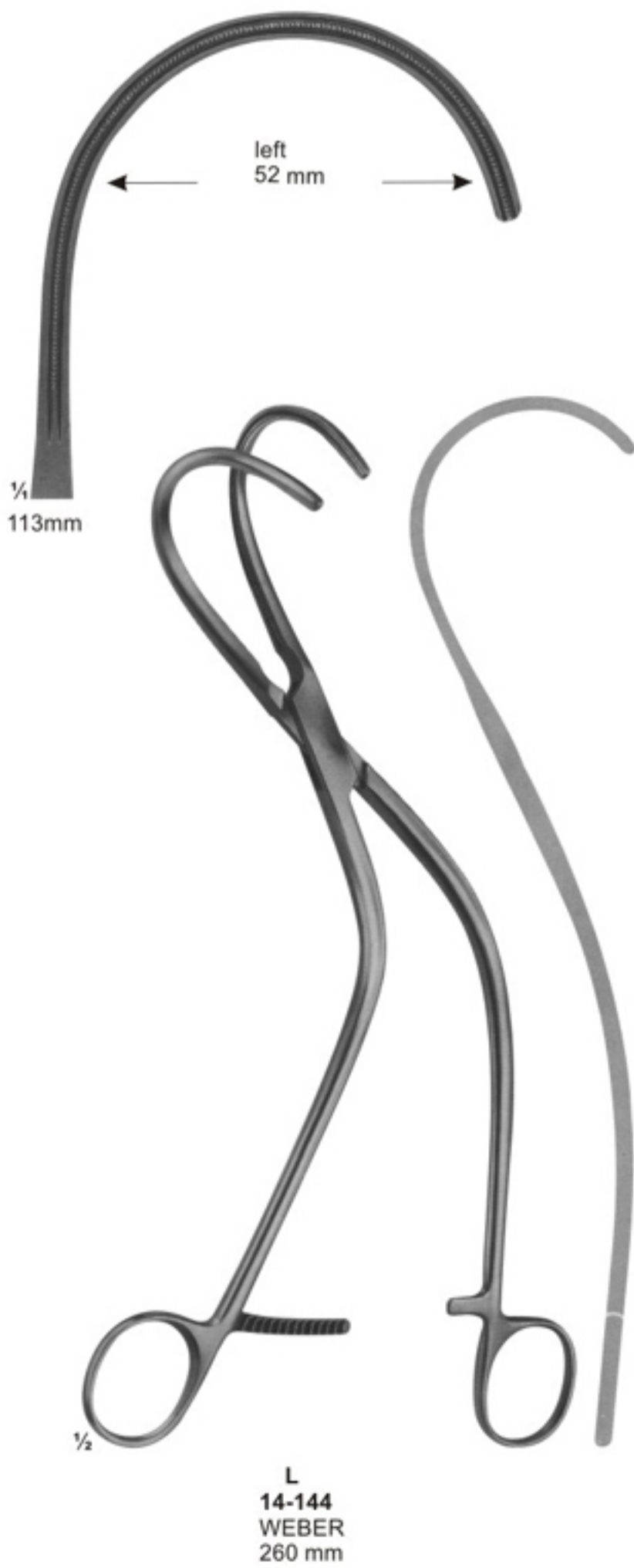

Multi- Purpose-Clamps

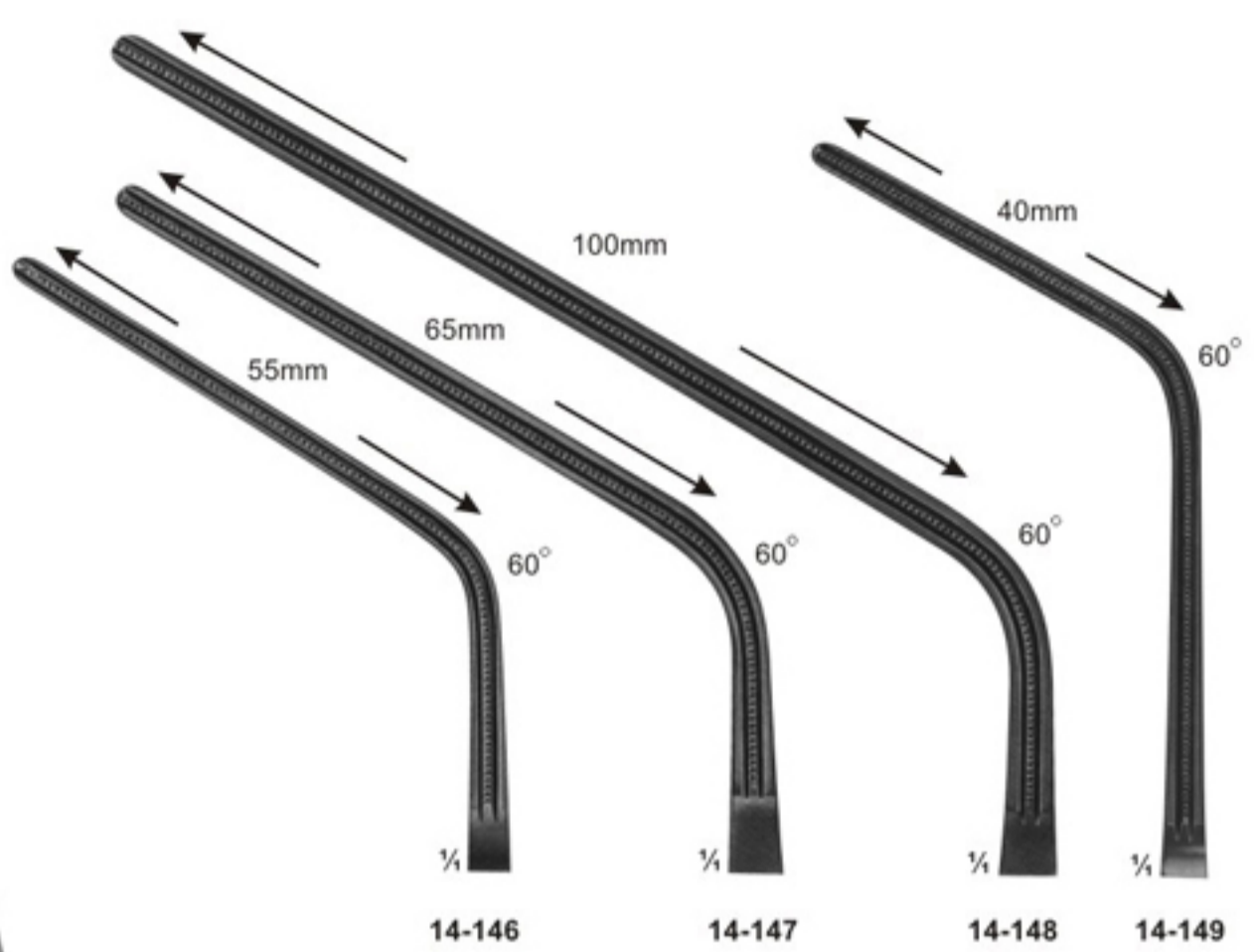

Total Length:	230 mm	280 mm	305 mm	240 mm
Length of jaws:	85 mm	100 mm	135 mm	93 mm

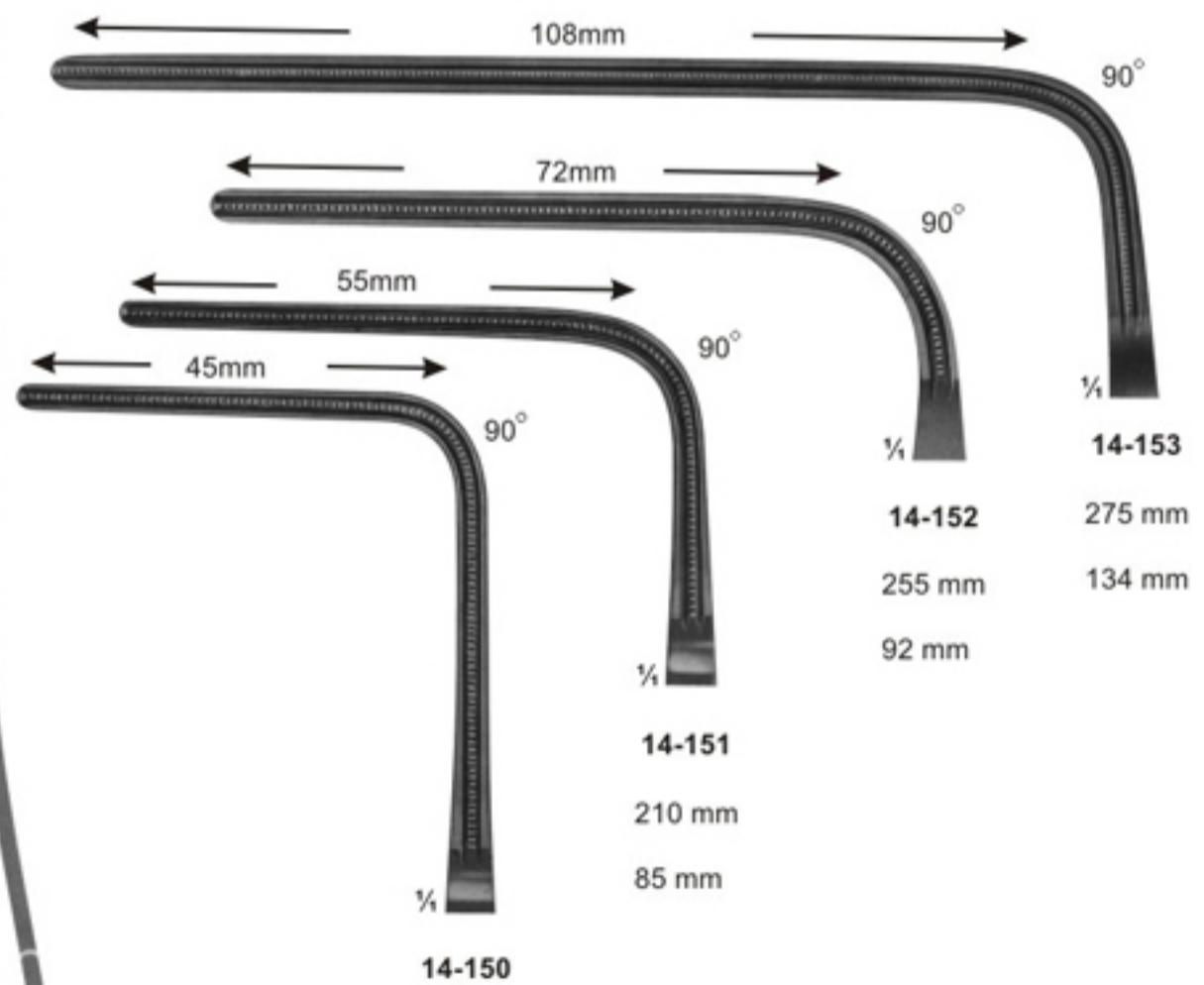

Total Length:	225 mm	275 mm	255 mm	210 mm
Length of jaws:	93 mm	134 mm	92 mm	85 mm

Sternum Instruments and Rib Shears



14-154
SCHUMACHER
Sternum shears
210 mm



14-155
LEBSCHKE
Sternum chisel
200 mm



14-156
230 mm



14-157
COLLIN
195 mm



14-158
GLUCK
190 mm



14-159
BETHUNE
340 mm



14-160
BRUNNER
Universal pattern
340 mm



14-161
GIERTZ-STILLE
250 mm

Rib Spreaders

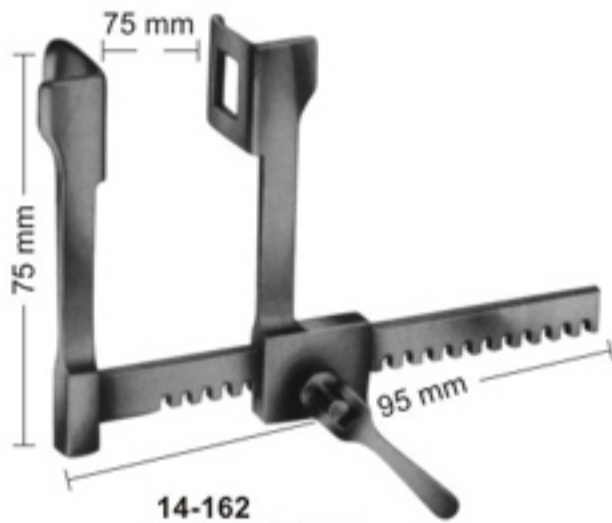

14-162
FINOCHIETTO
Blades
18X21 mm

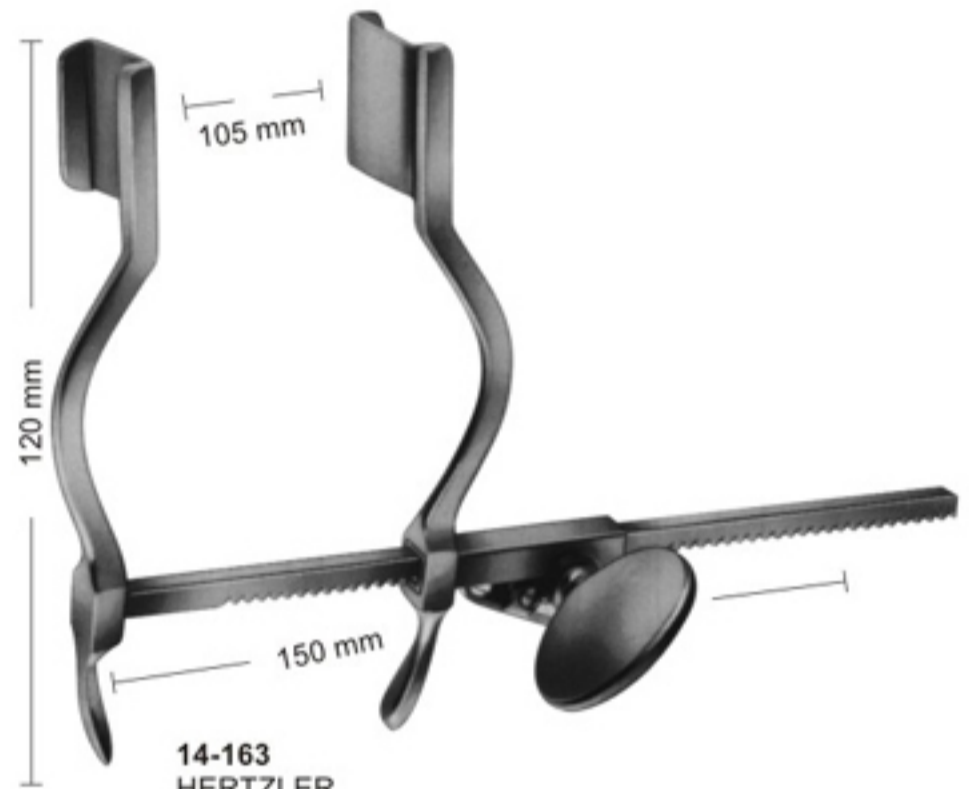

14-163
HERTZLER
Blades
20X25 mm

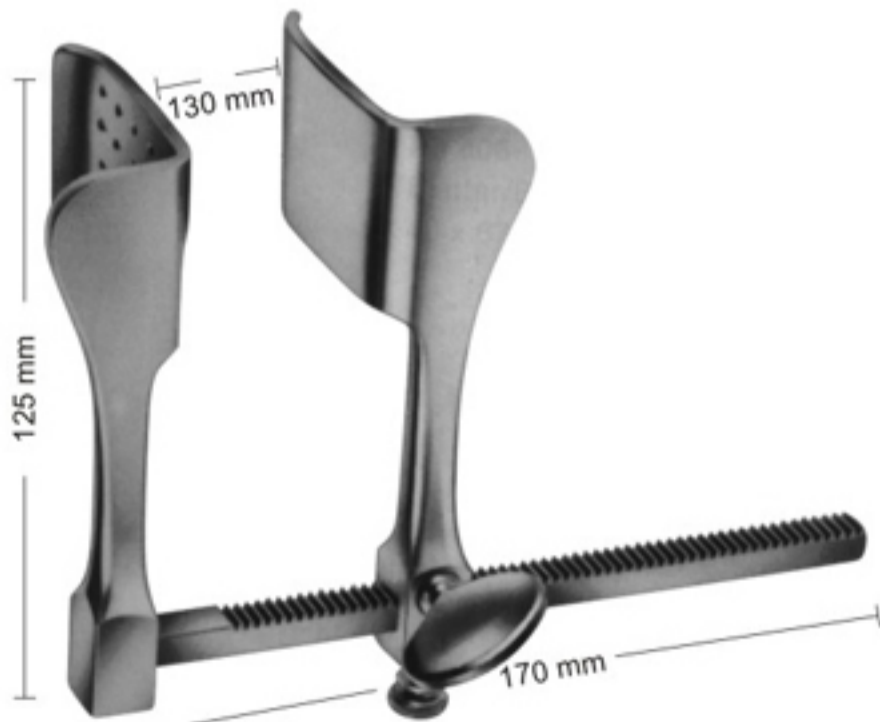

14-164
TUFFIER
Blades
43X53 mm

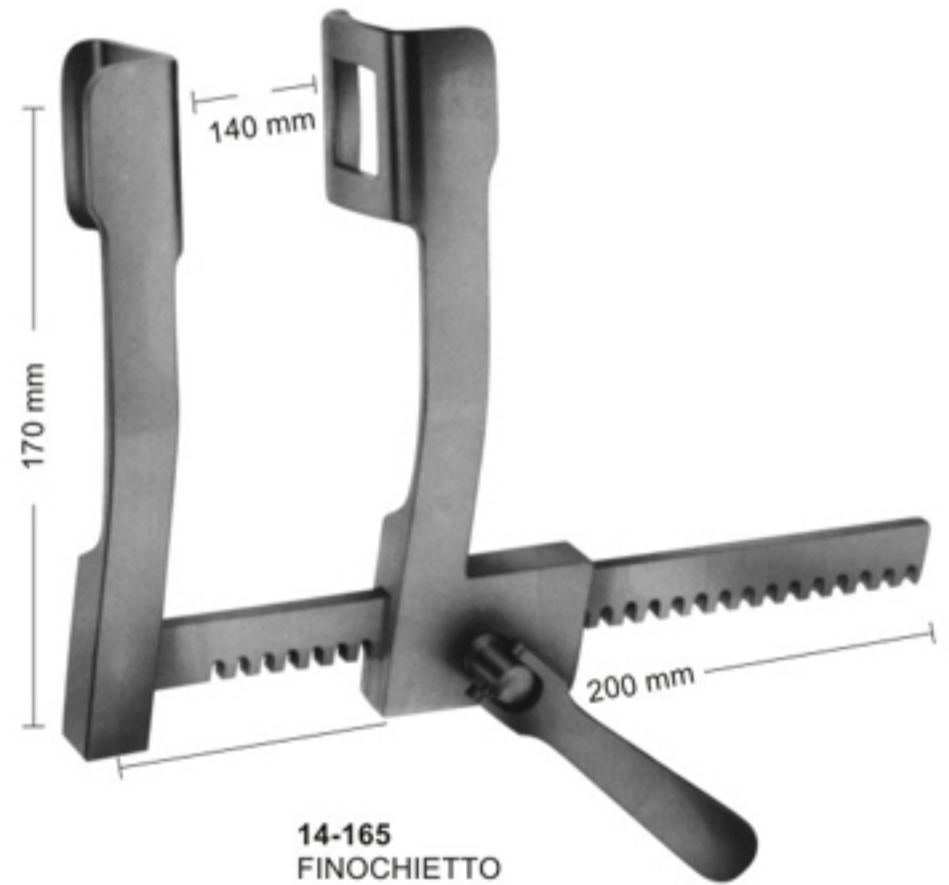

14-165
FINOCHIETTO
Blades
36X45 mm

Rib Spreaders-and Contractors



1/2

**14-166
SELLORS**
Rib spreader-and contractor
with swivel blades
200 mm



1/2

**14-167
BAILEY**
150 mm



14-168
for children

14-169
for adults

1/2

**14-168 - 169
BAILEY**
200 mm

Punches

130°

upwards cutting

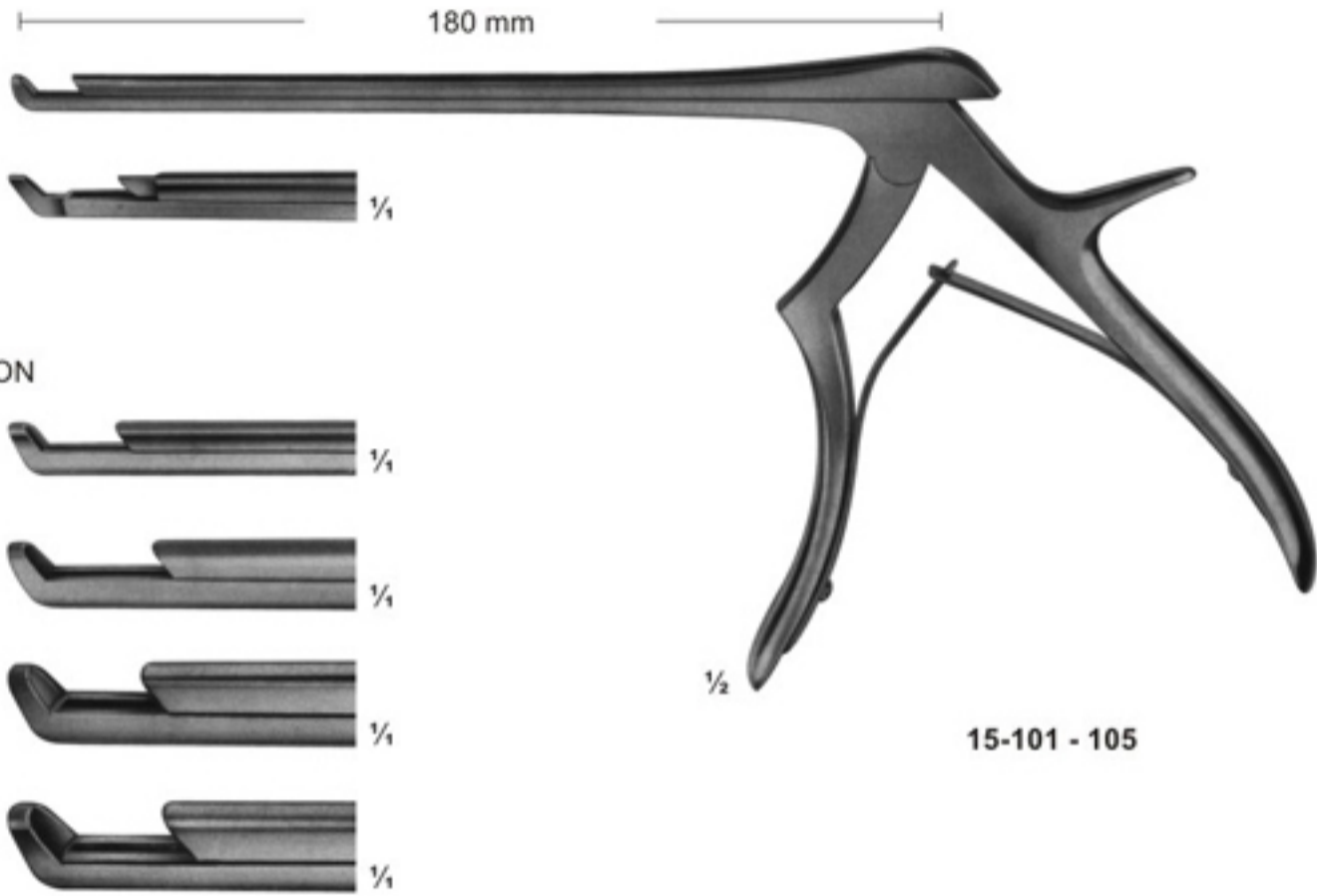

90°

upwards cutting

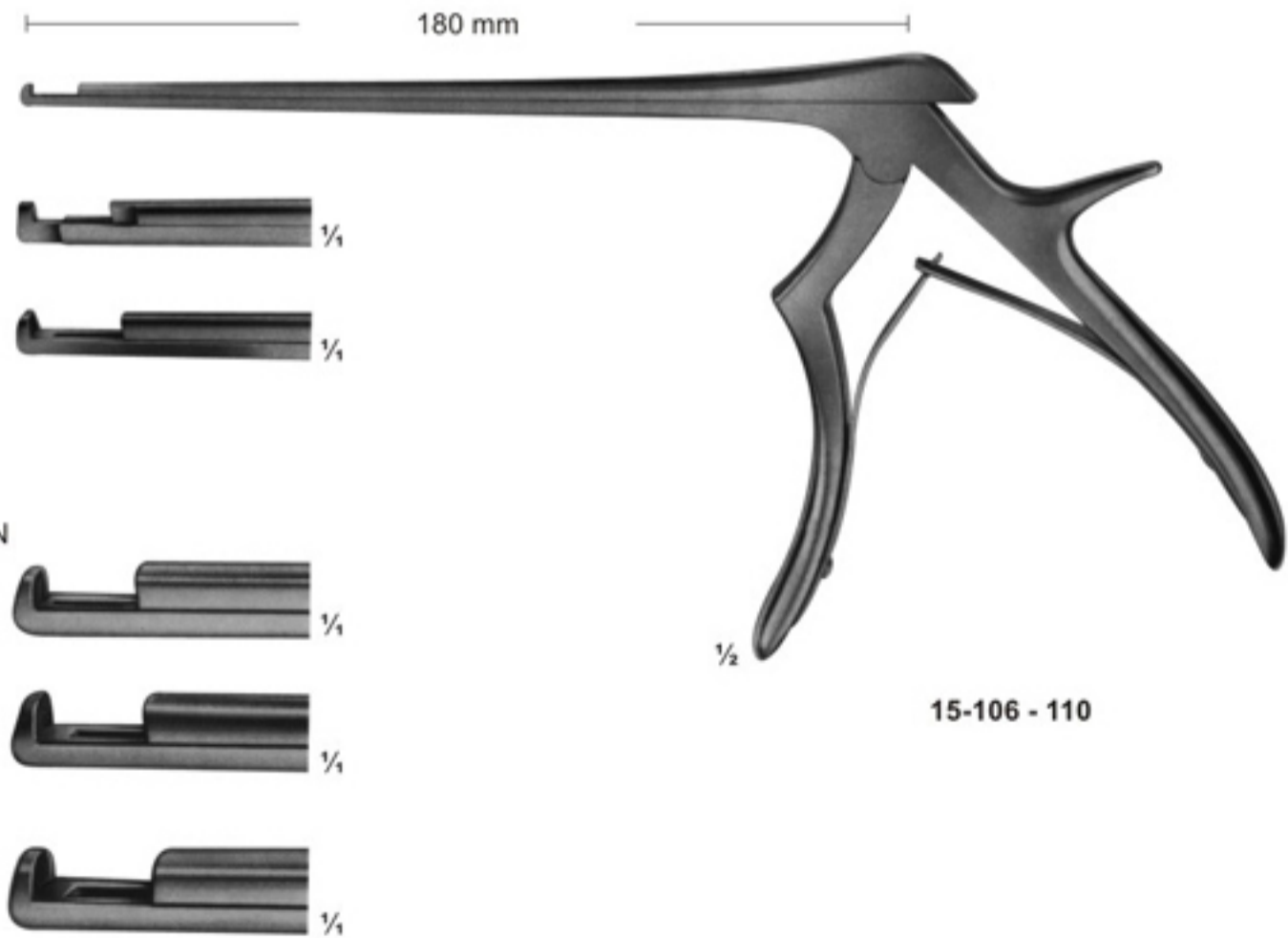

Punches

90° upwards cutting

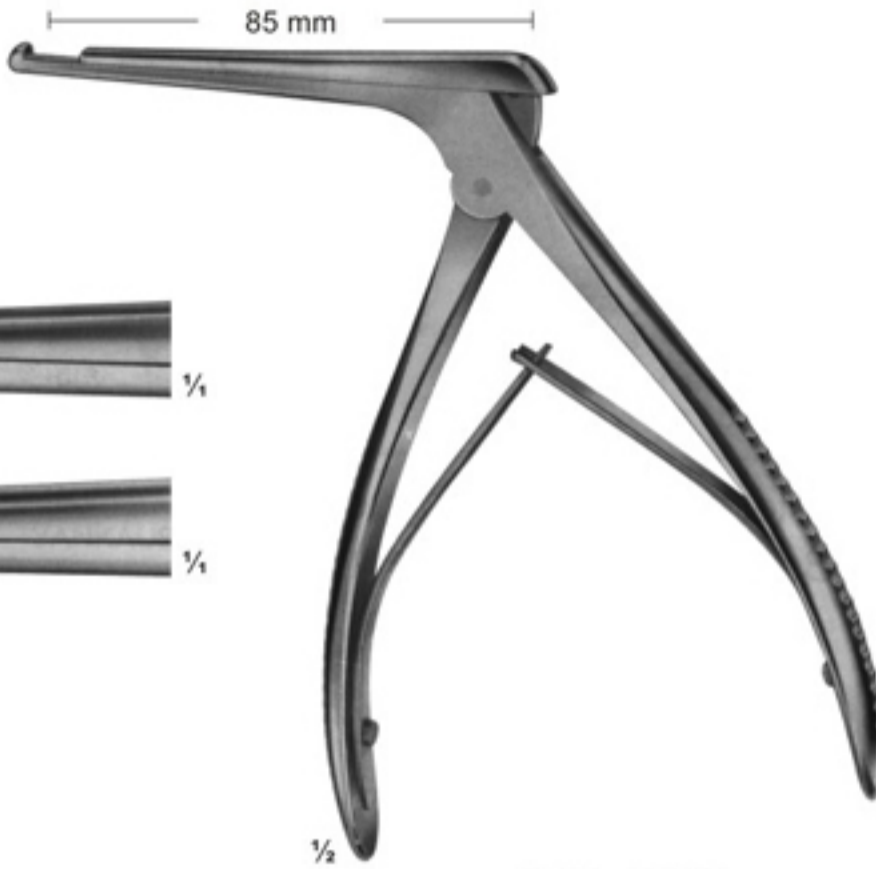

15-111
4 mm



15-112
5 mm



15-111 - 15-112
KERRISON

90° upwards cutting

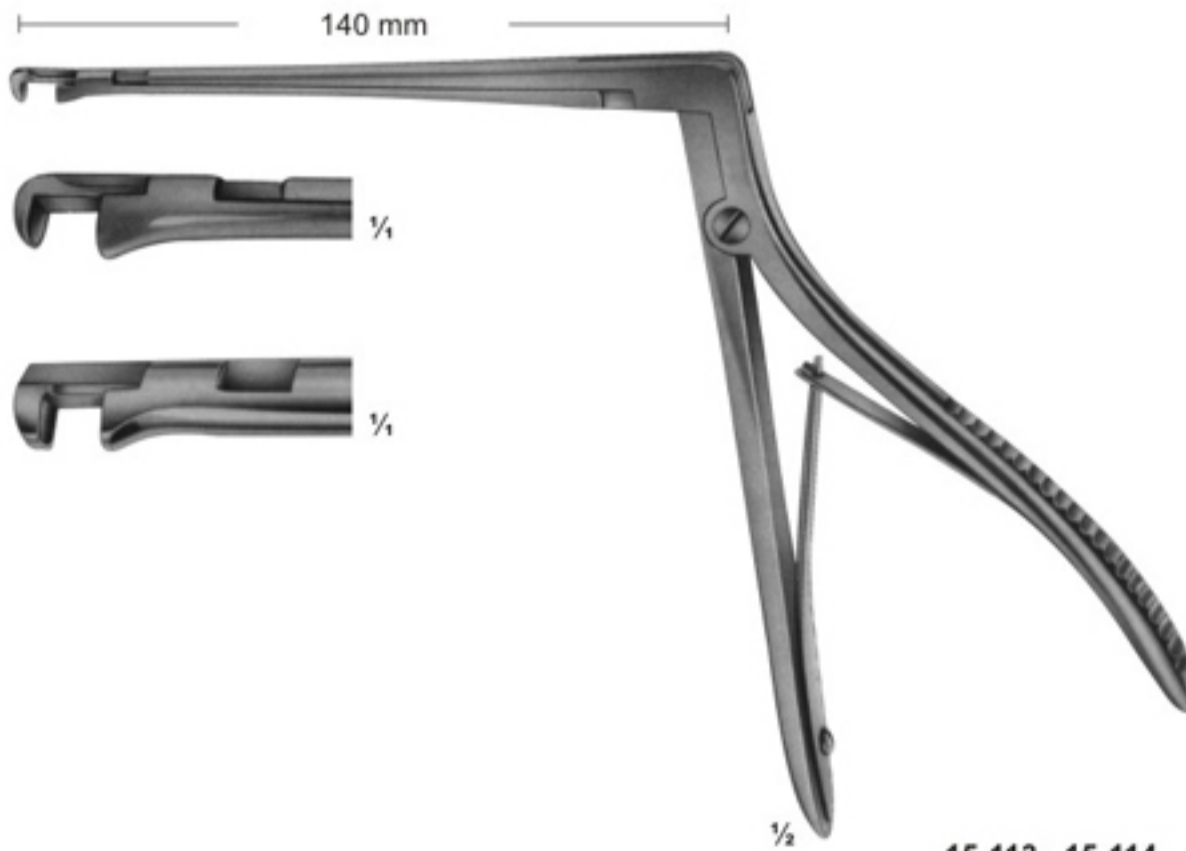

15-113
3,3 mm



15-114
4,0 mm



15-113 - 15-114
HAJEK-KOFLER

Rongeurs

LOVE-GRUENWALD

15-115
2 X 10 mm

15-116
3 X 10 mm

SPURLING
15-117
4 X 10 mm

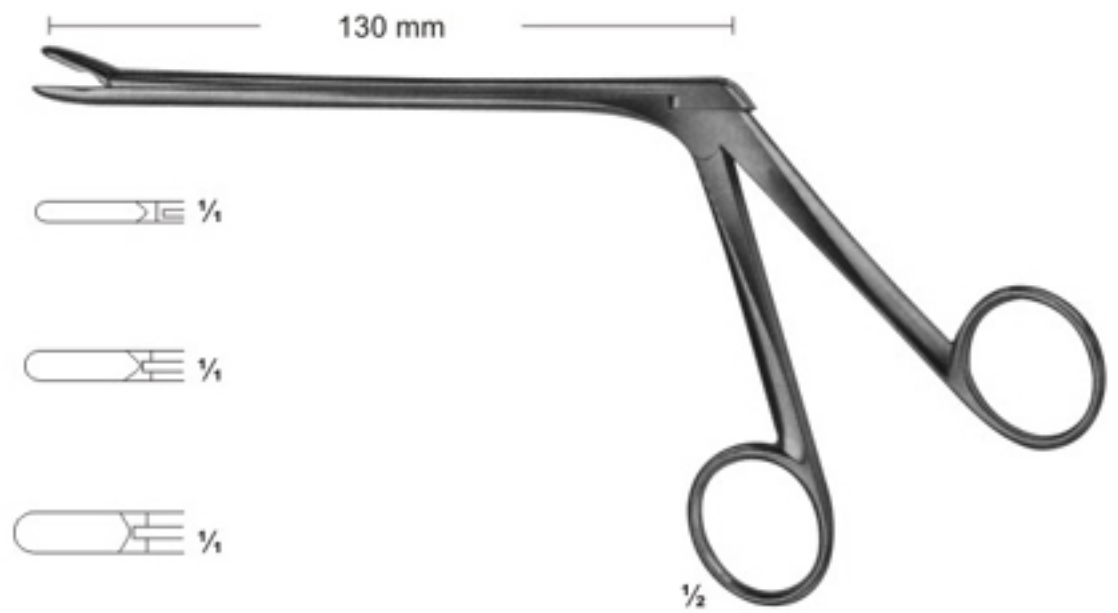

15-115 - 15-117

15-118
2 mm

15-119
3 mm

15-120
4 mm

15-121
5 mm

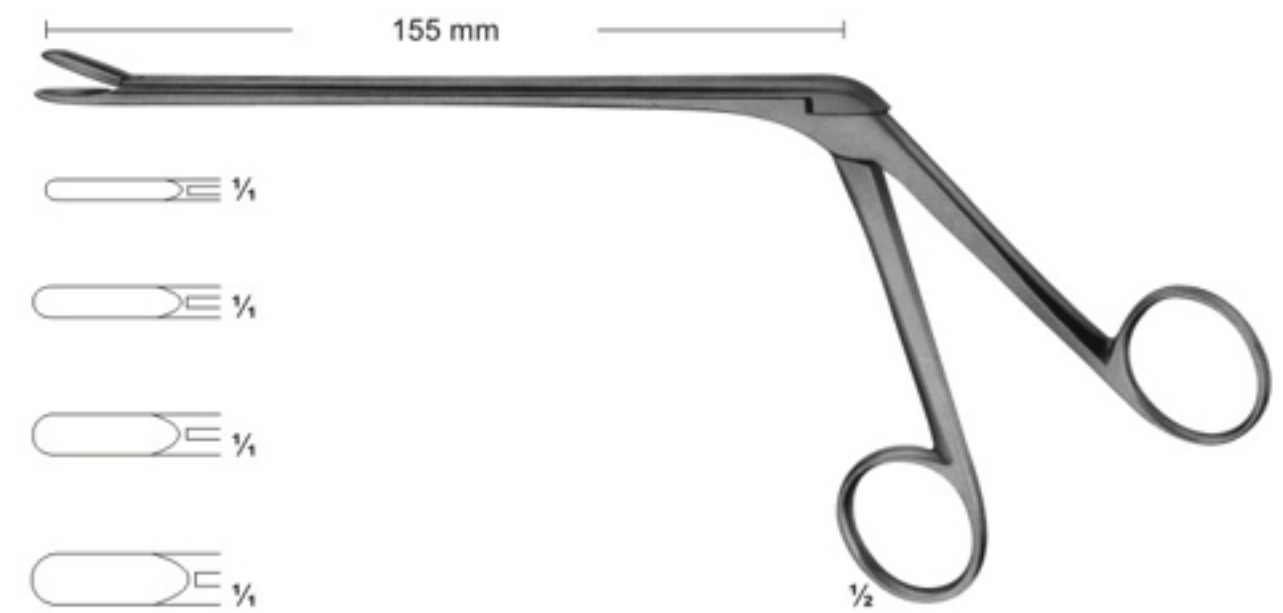

15-118 - 15-121
CASPAR

150°

15-122
2 mm

15-123
3 mm

15-124
4 mm

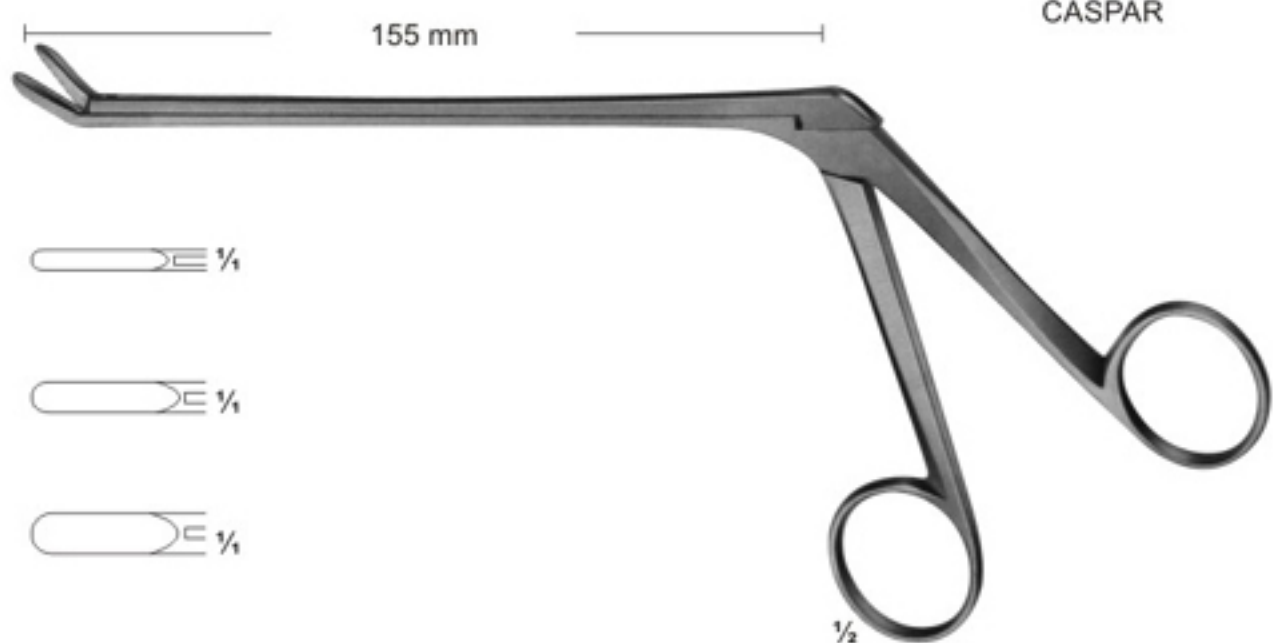

15-122 - 15-124
CASPAR

Rongeurs

Angled positions for rongeurs

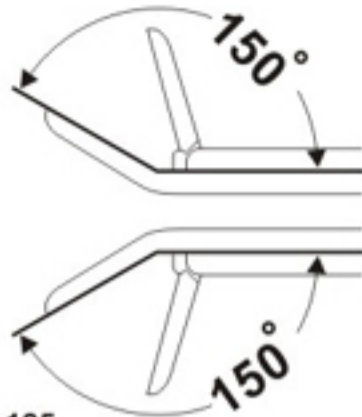

15-125
3,0 mm

15-126
3,6 mm

15-127
4,2 mm

15-128
4,8 mm

15-129
5,8 mm

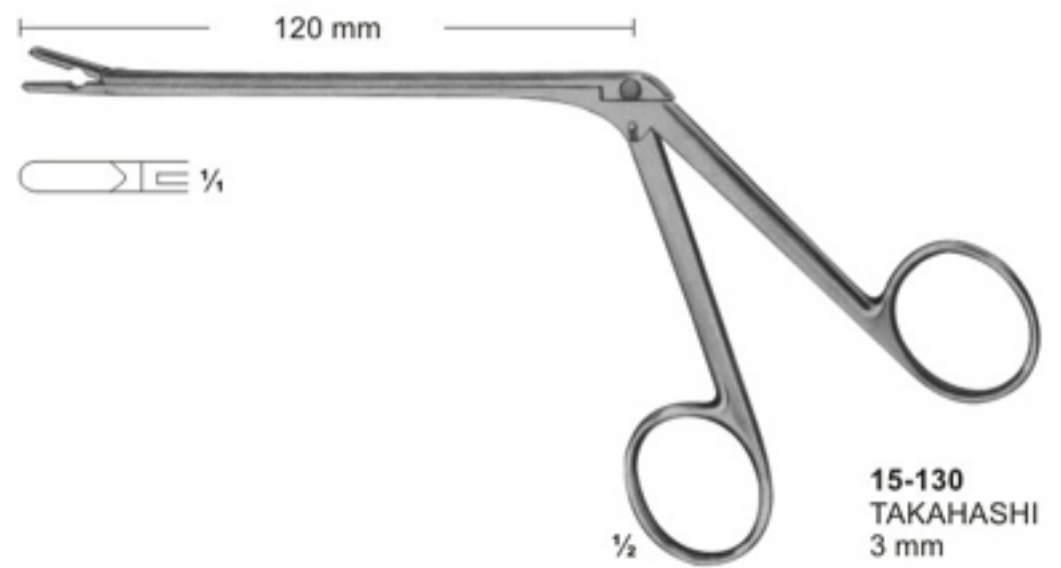
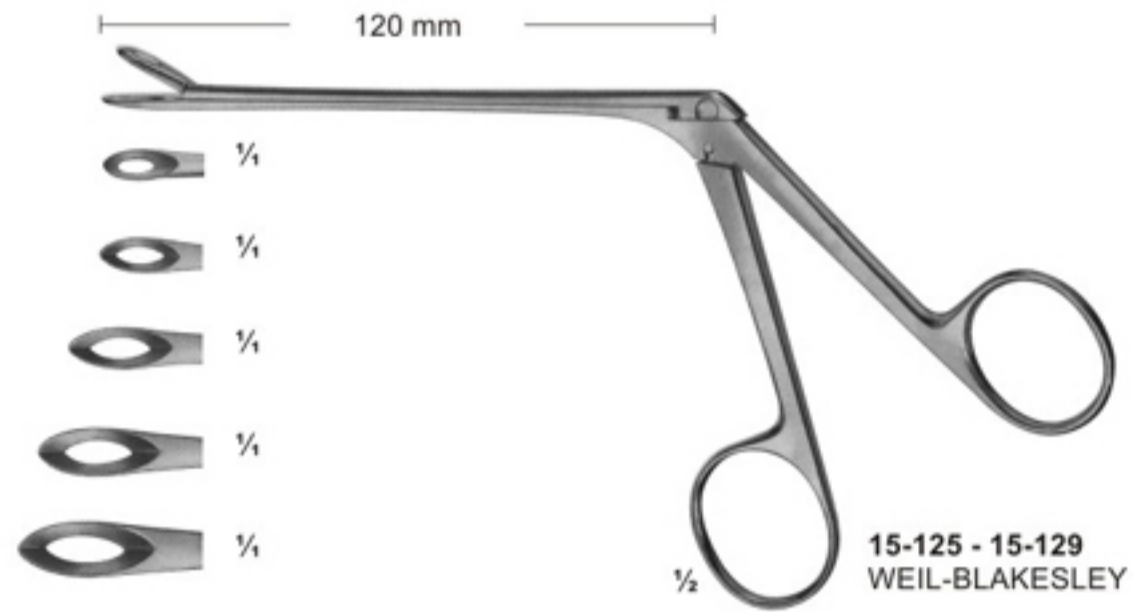
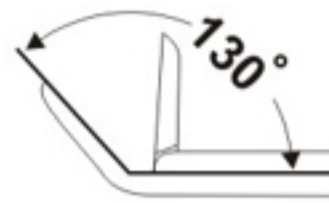
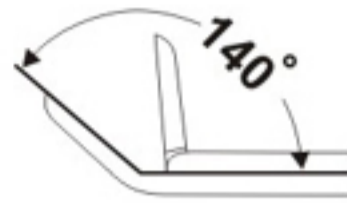

130°

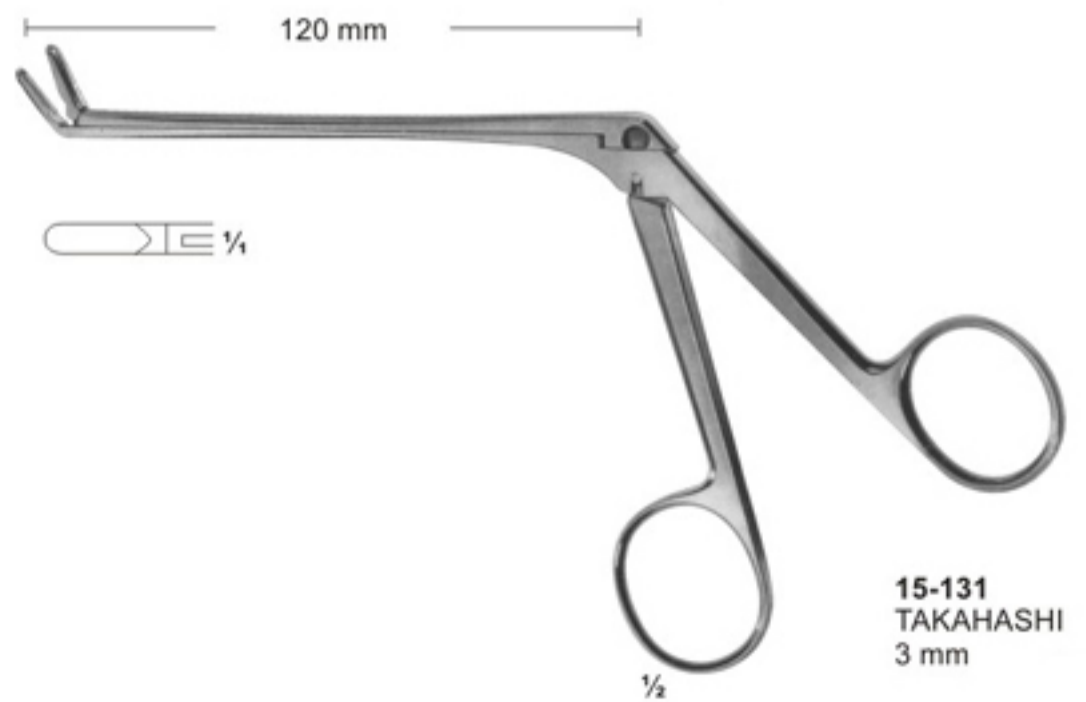

Rongeurs

150°

Lower part of jaws movable

15-132
2 mm

15-133
3 mm

15-134
4 mm

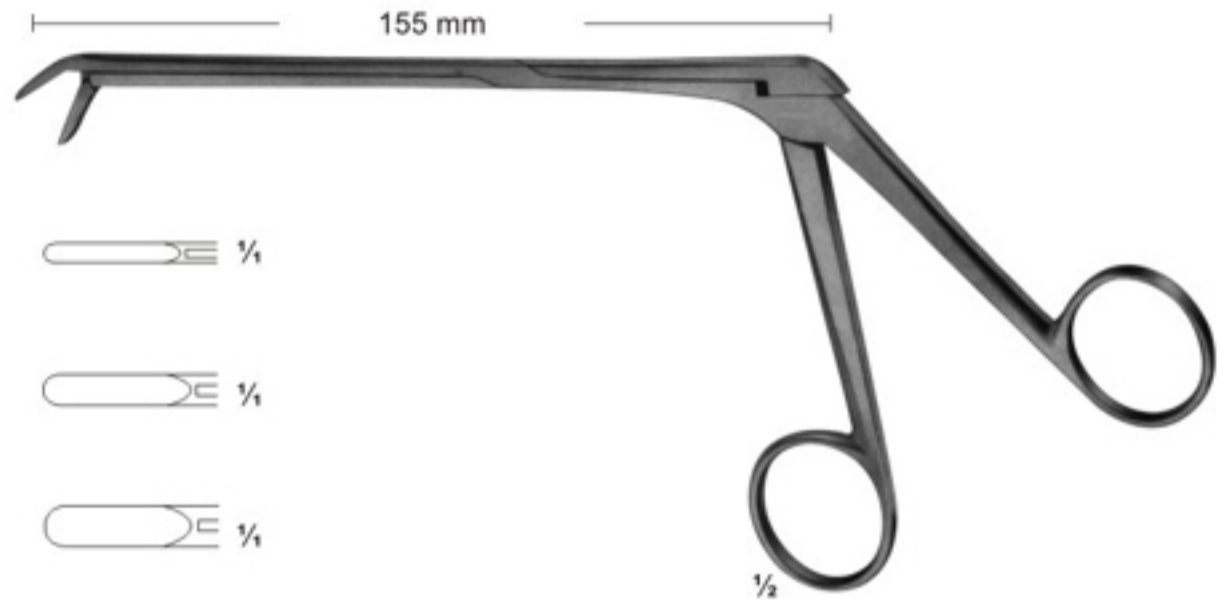

15-132 - 15-134
CASPAR

Length of shaft 140 mm	Length of shaft 160 mm	Length of shaft 185 mm	size of jaws
15-135	15-140	15-145	2 X12 mm
15-136	15-141	15-146	3 X12 mm
15-137	15-142	15-147	4 X14 mm
15-138	15-143	15-148	5 X14 mm
15-139	15-144	15-149	6 X16 mm

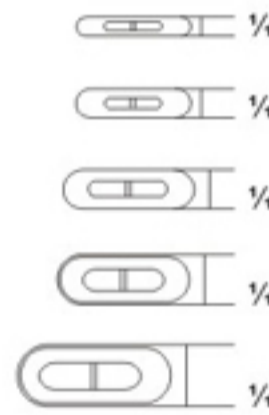

15-135 - 15-149
CASPAR

150°

Length of shaft 140 mm	Length of shaft 160 mm	Length of shaft 185 mm	size of jaws
15-150	15-153	15-156	3 X12 mm
15-151	15-154	15-157	4 X14 mm
15-152	15-155	15-158	5 X14 mm

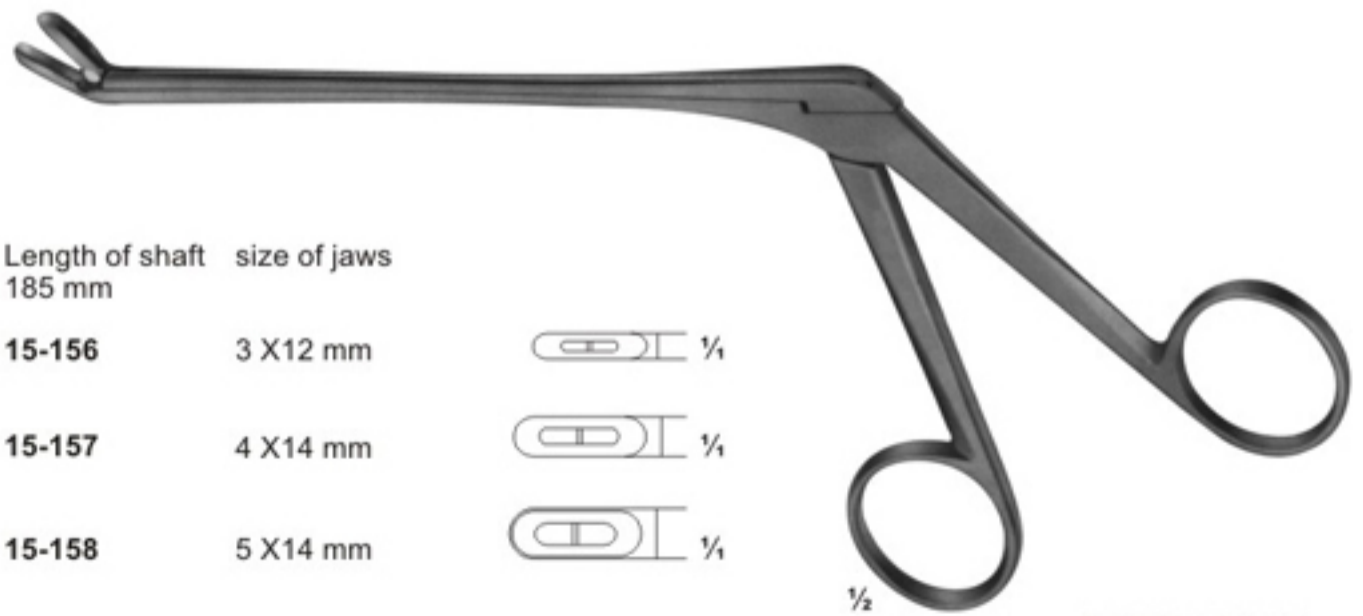

15-150 - 15-158
CASPAR

Rongeurs

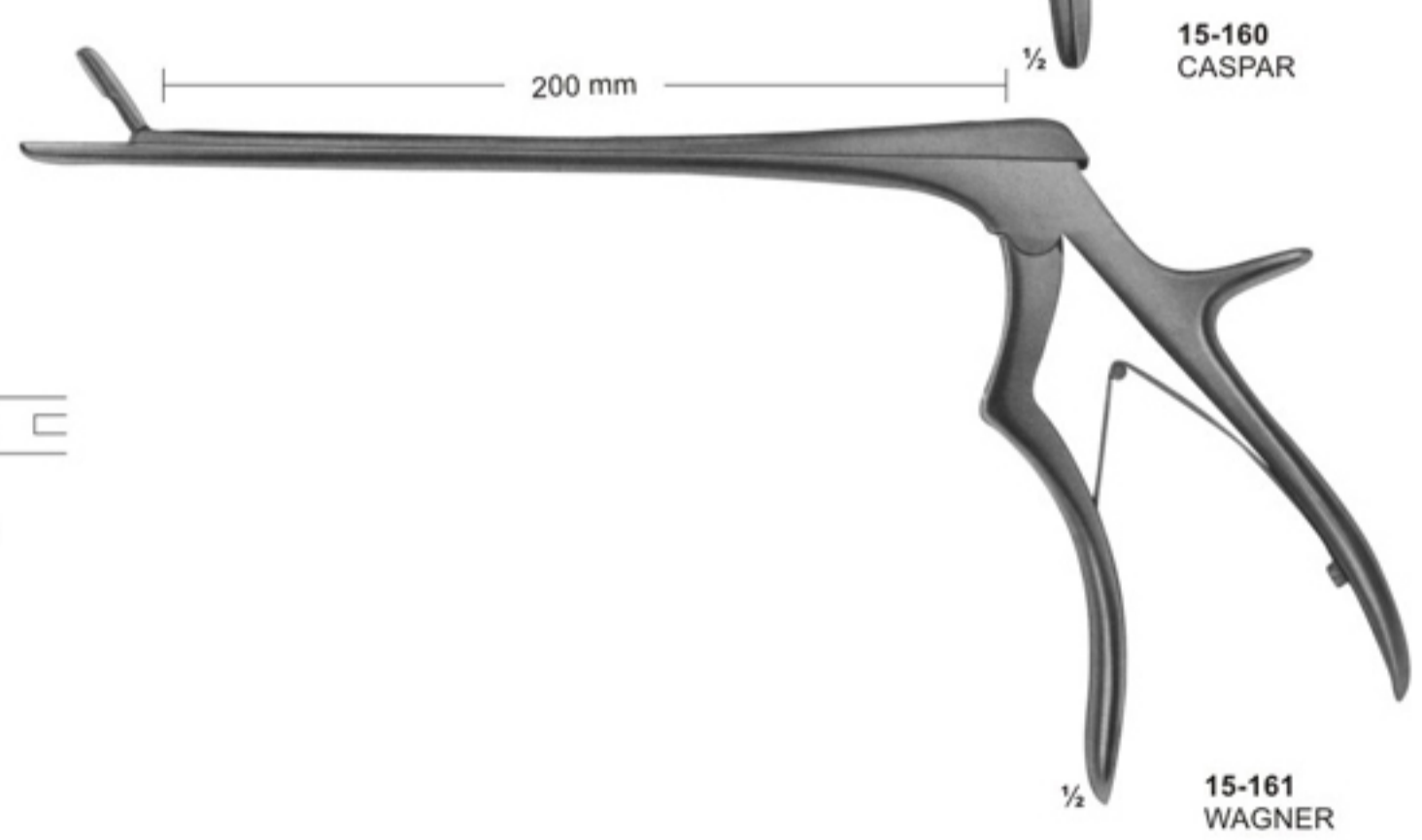
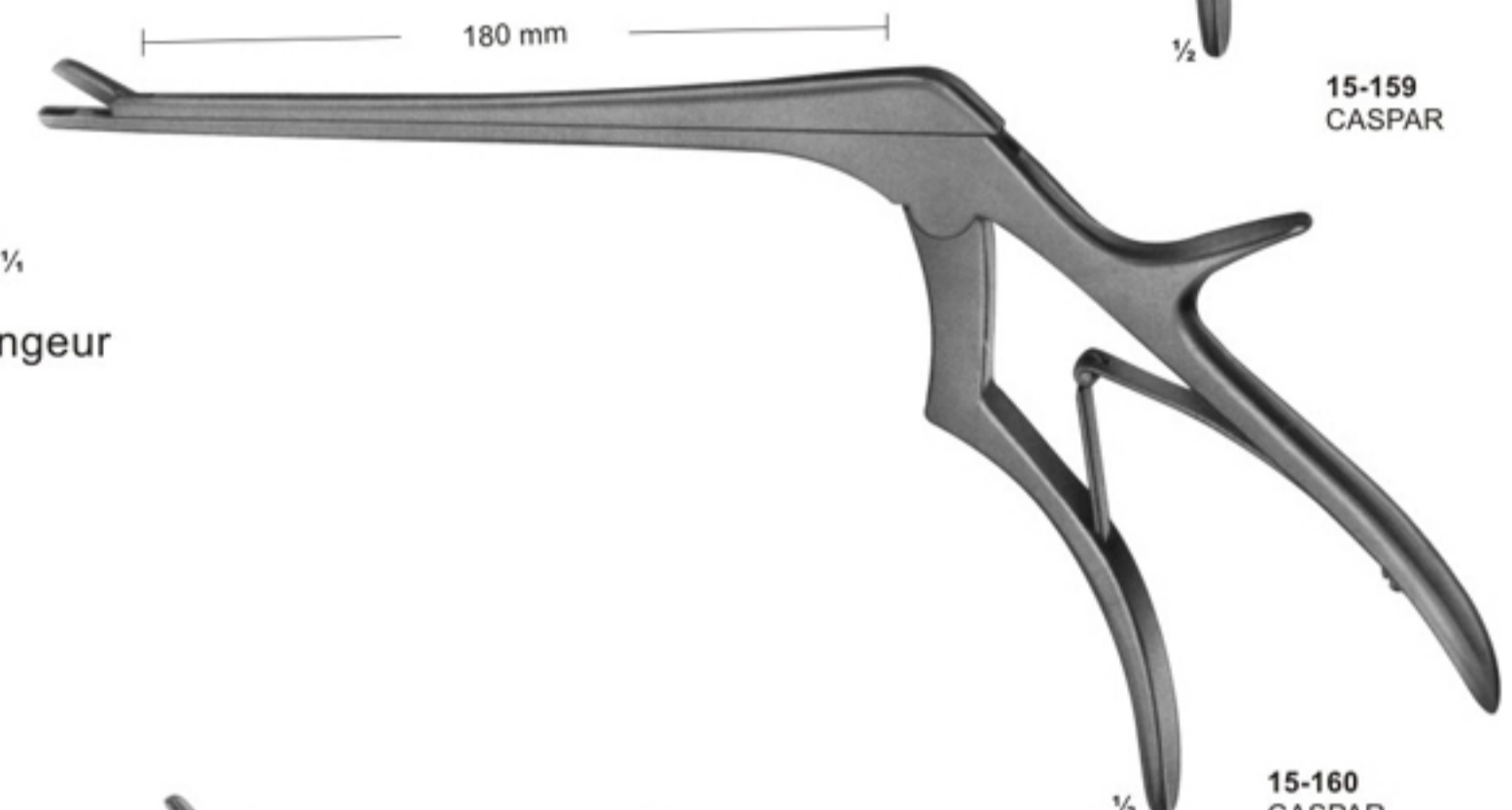
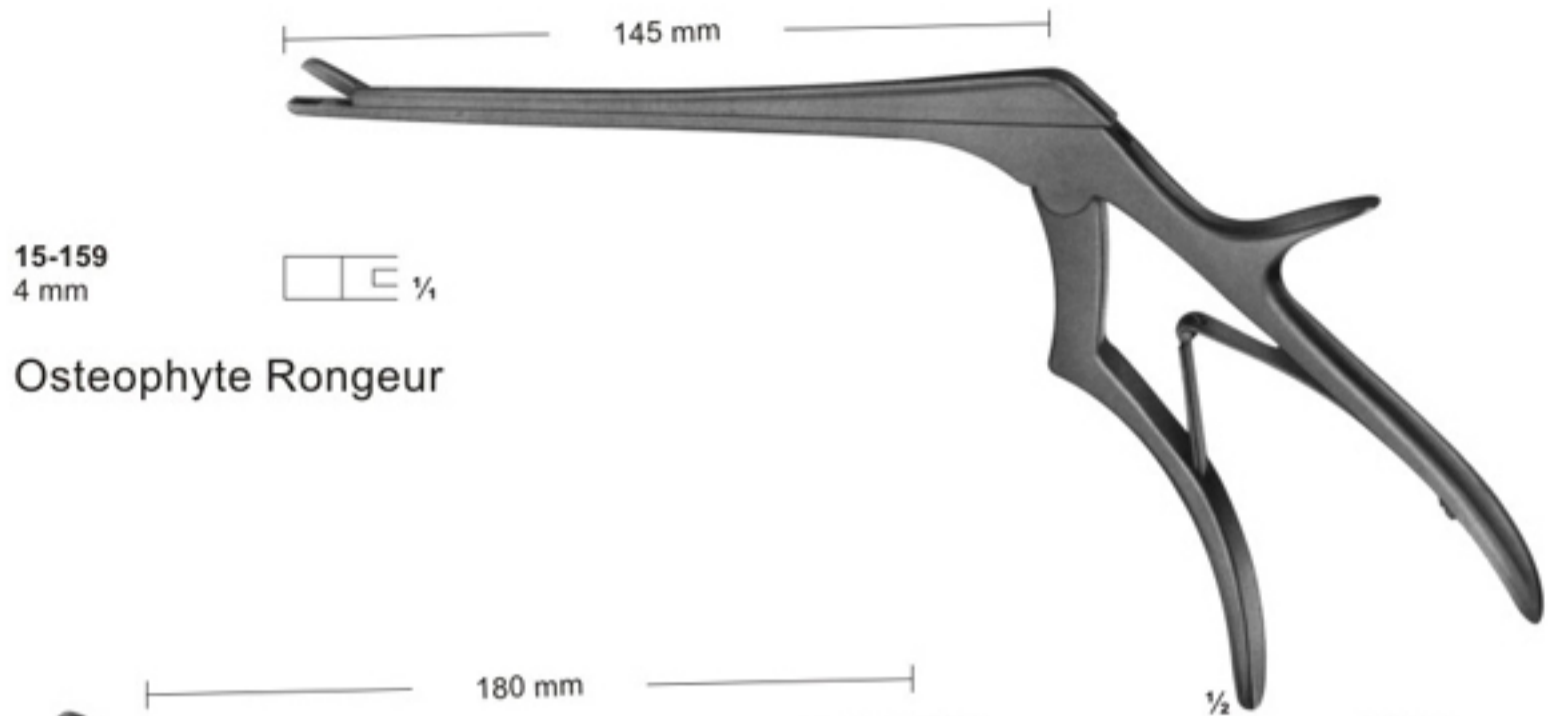

Elevators and Bone Levers

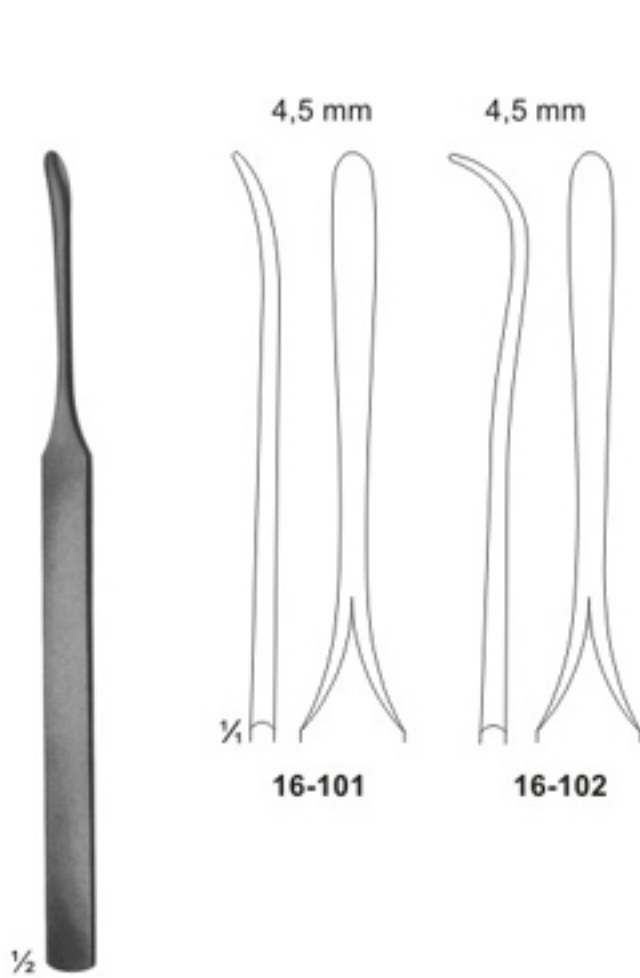

16-101 - 102
KONIG
155 mm



16-103
WILLIGER
165 mm

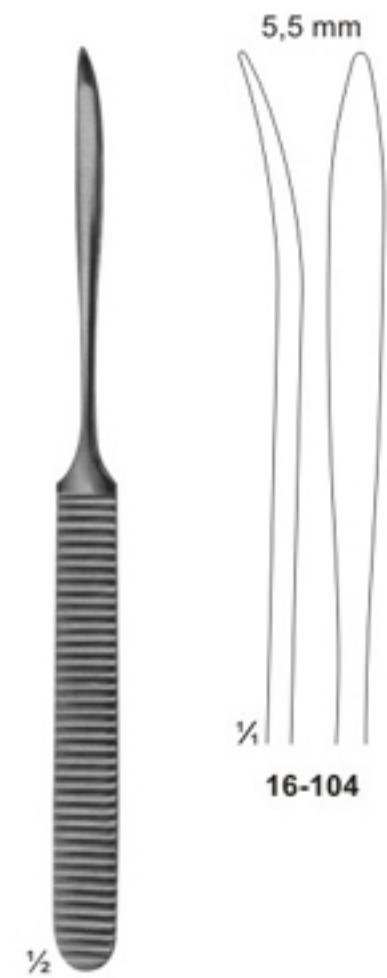

16-104
WILLIGER
170 mm

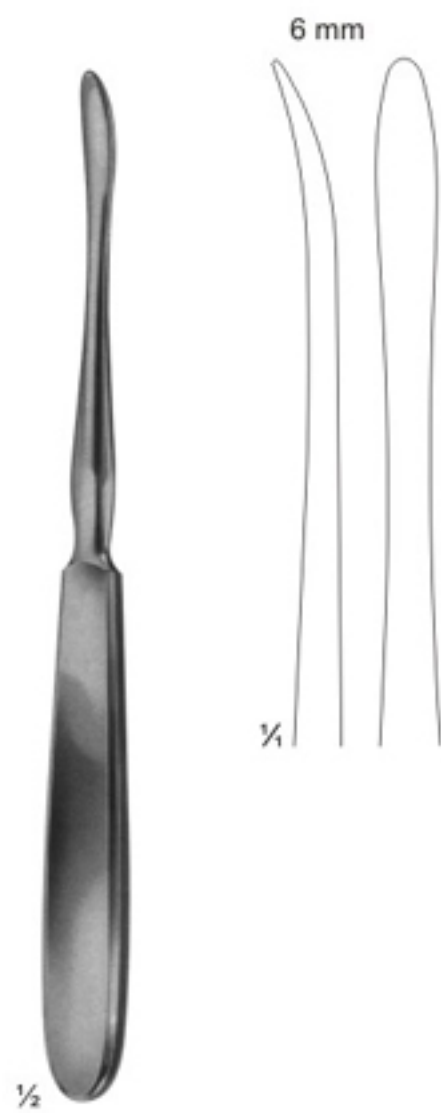

16-105
QUERVAIN
195 mm

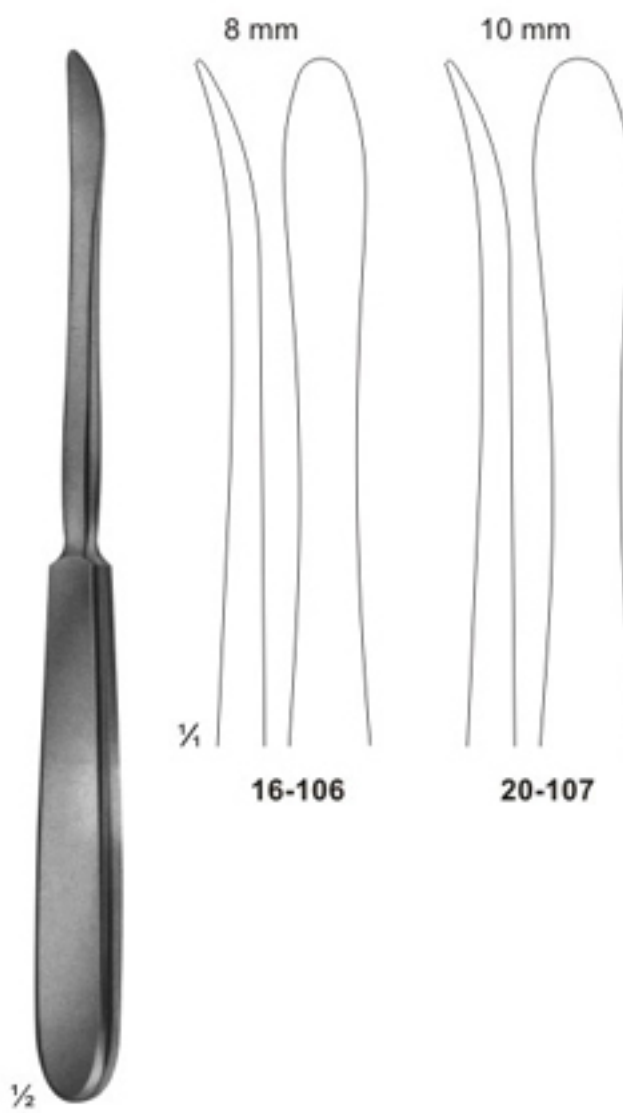

16-106 - 107
LANGENBACK
195 mm

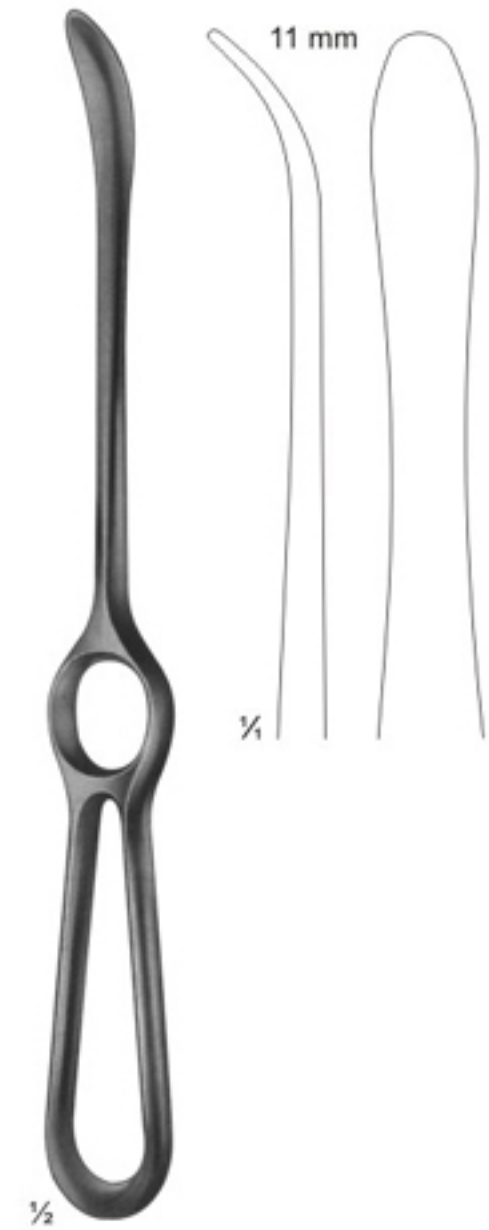

16-108
LANGENBACK
230mm

Bone Levers



1/2
16-109
LANE TRETOWAN
215mm

1/2
16-110
LANE
255mm

1/2
16-111
LANGE-HOHMANN
250mm

1/2
16-112 - 113
LANGE-HOHMANN modif.
16-112 265mm
16-113 280mm

16-112
30 mm
16-113
33 mm

Raspatories



16-114
PARTSCH
150 mm

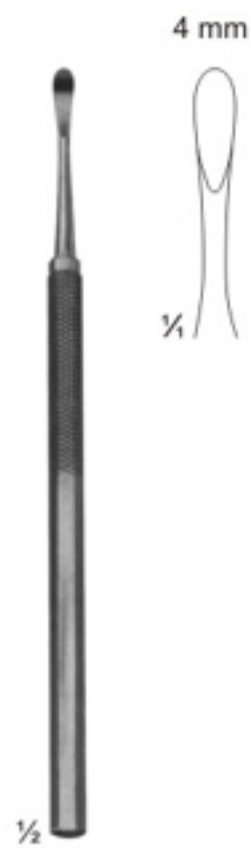

16-116
PARTSCH mod. LANGE
145 mm



16-117
MC KENTY
155 mm

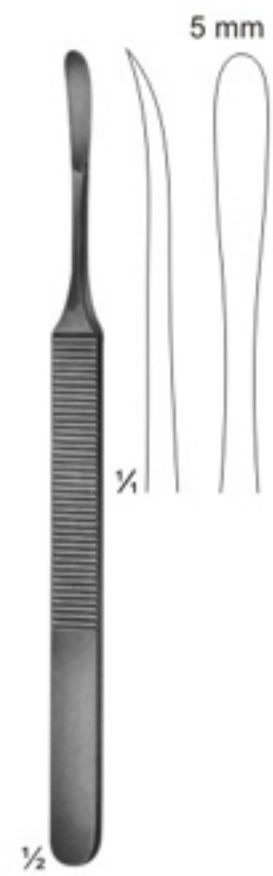

16-118
KOENIG
155 mm

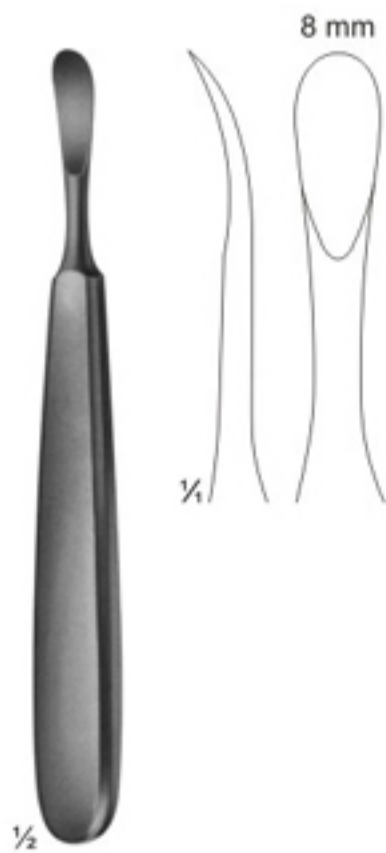

16-119
TRELAT
150 mm

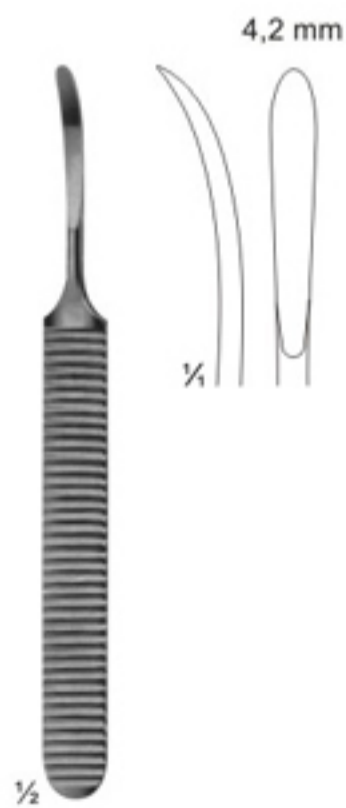

16-120
WILLIGER
140 mm



16-121
WILLIGER
160 mm

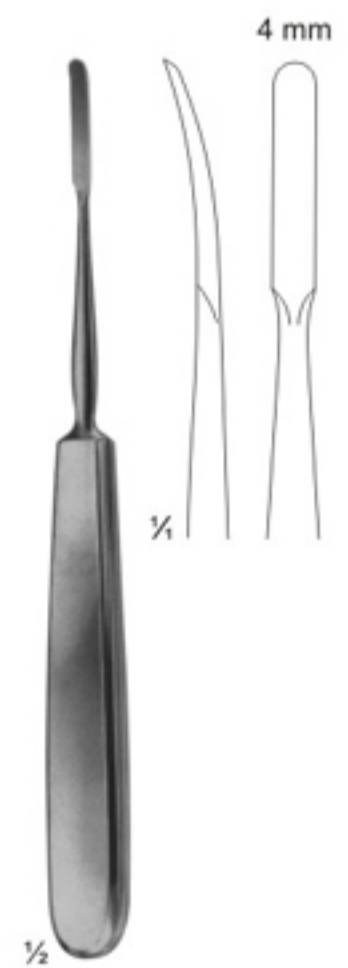

16-122
JOSEPH
170 mm

Bone File and Rasps

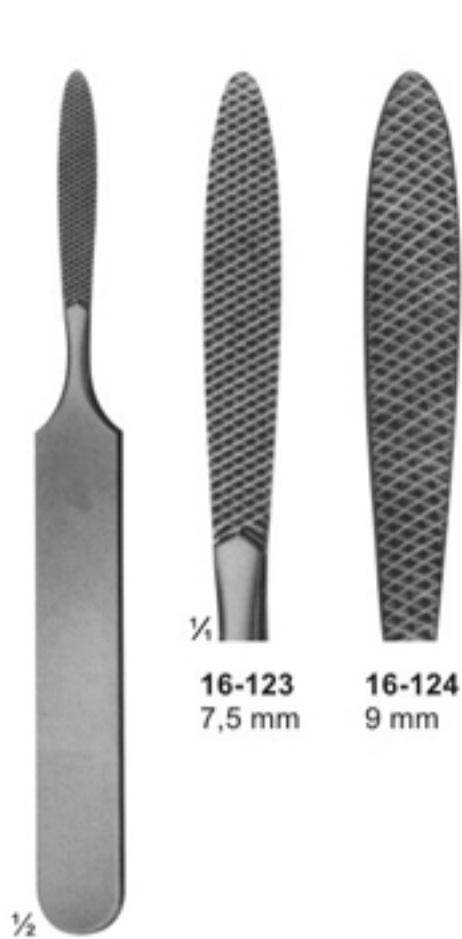

$\frac{1}{2}$
16-123
JOSEPH
fine, chequered

$\frac{1}{4}$
16-123
7,5 mm

$\frac{1}{4}$
16-124
9 mm

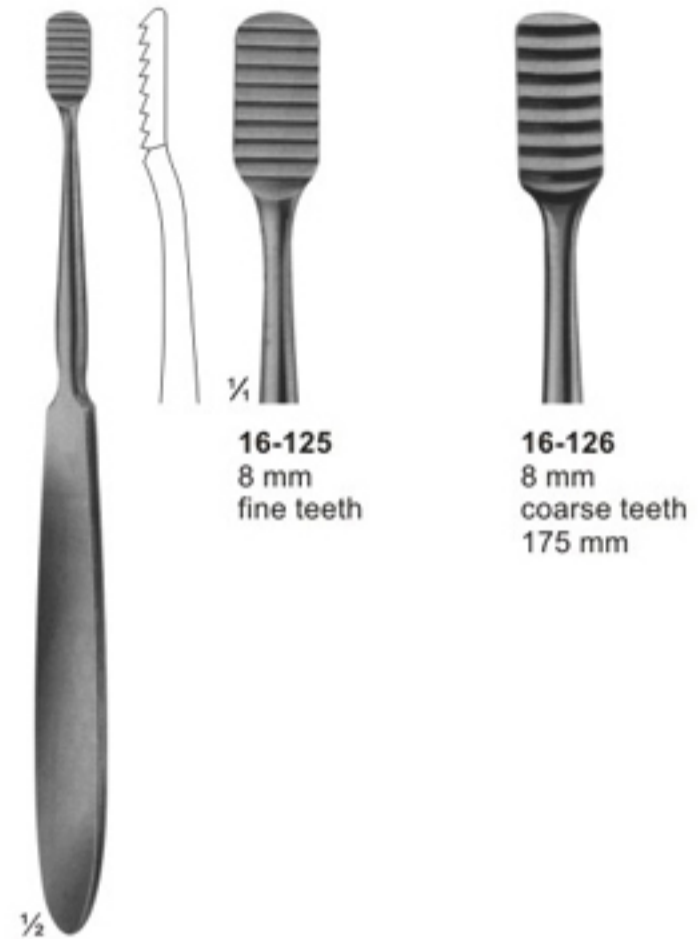

$\frac{1}{2}$
16-125 - 16-126
LEWIS

$\frac{1}{4}$
16-125
8 mm
fine teeth

$\frac{1}{4}$
16-126
8 mm
coarse teeth
175 mm



$\frac{1}{2}$
16-127
MALTZ
down stroke
180 mm

$\frac{1}{4}$
9 mm

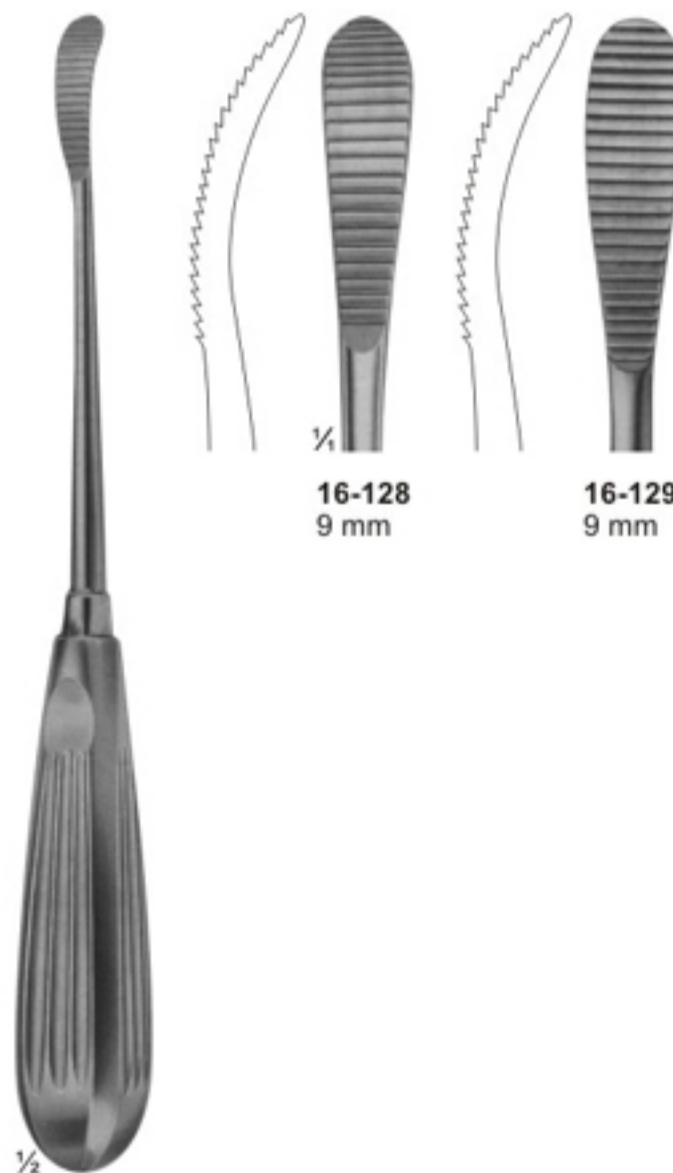

$\frac{1}{2}$
16-128 - 16-129
AUFRICHT
up stroke
16-129
down stroke
220 mm

$\frac{1}{4}$
16-128
9 mm

$\frac{1}{4}$
16-129
9 mm



$\frac{1}{2}$
16-130
GALLAHER
190 mm

$\frac{1}{4}$
6,5 mm

Bone Currettes



16-131
JACOBSON
140 mm



16-132
MARTINI
140 mm



16-133
MARTINI
140 mm



16-134
WILLIGER
145 mm



16-135
JANSEN
160 mm



16-136
BARTH
180 mm



16-137
VOLKMANN
130 mm

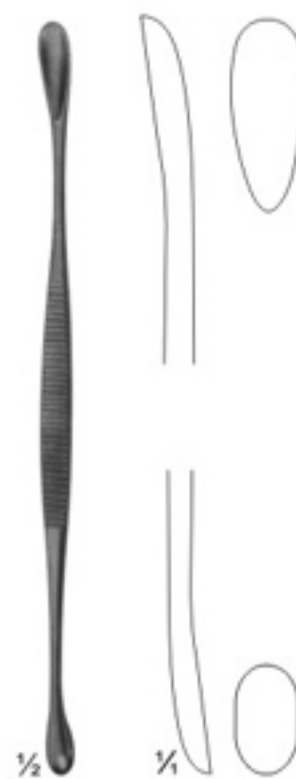

16-138
VOLKMANN
145 mm

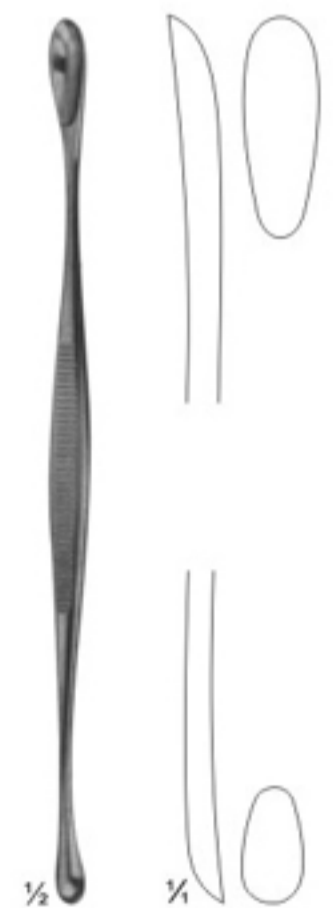

16-139
VOLKMANN
170 mm

Mallets Weights refer to the heads of the mallets
Hammer Die Gewichtsangaben beziehen sich auf den Kopf des jeweiligen Hammers



17-101
MEAD
185 g
with interchangeable
plastic disks
190 mm
17-102
pair of spare disks



17-103
140 g
with interchangeable
plastic disks
185 mm
17-104
pair of spare disks



17-105
COTTLE
140 g
1 Side Flat
1 Side convex
185 mm



17-106
165 g
lead filled head
190 mm

Osteotomes, Chisels and Gouges



17-107
MANNERFELT
Gouge
155 mm

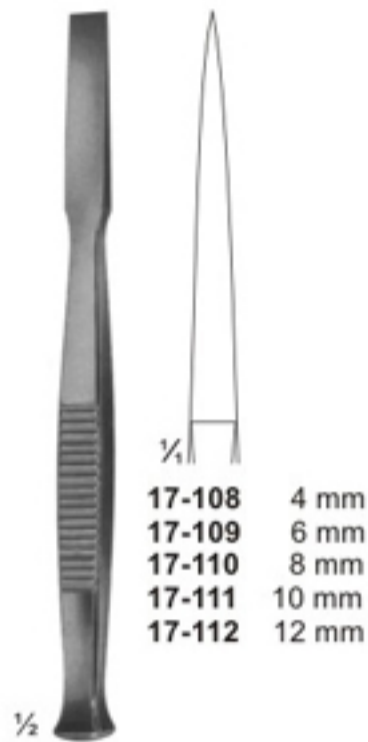

17-108 - 112
Osteotomes
140 mm

- 17-108** 4 mm
- 17-109** 6 mm
- 17-110** 8 mm
- 17-111** 10 mm
- 17-112** 12 mm

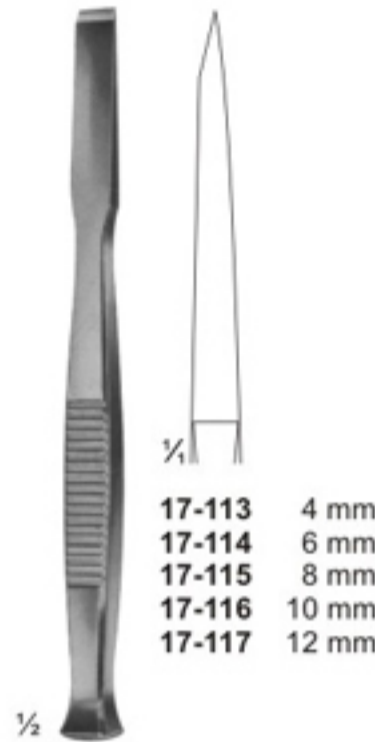

17-113 - 117
Chisels
140 mm

- 17-113** 4 mm
- 17-114** 6 mm
- 17-115** 8 mm
- 17-116** 10 mm
- 17-117** 12 mm

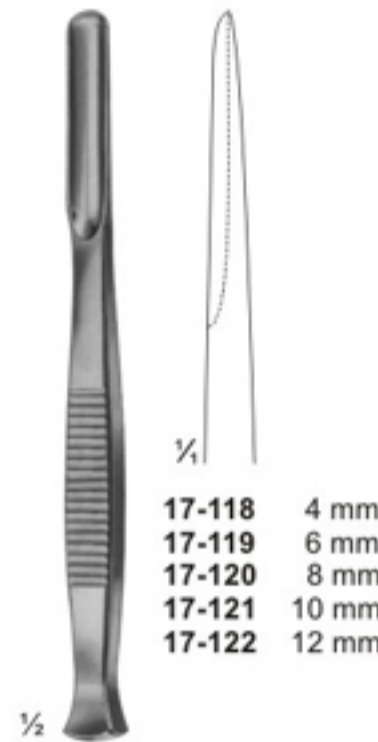

17-118 - 122
Gouges
140 mm

- 17-118** 4 mm
- 17-119** 6 mm
- 17-120** 8 mm
- 17-121** 10 mm
- 17-122** 12 mm

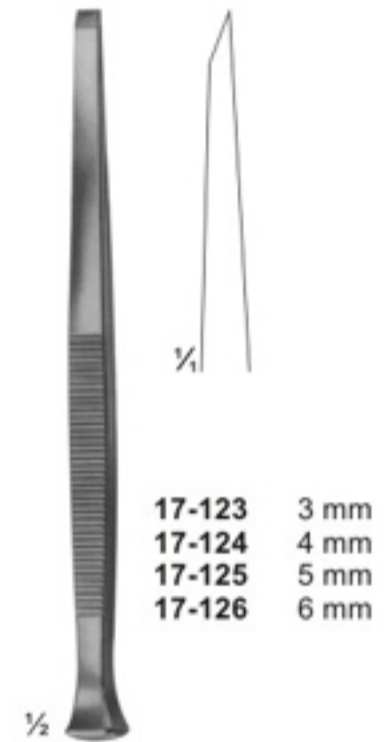

PARTSCH
17-123 - 126
Chisels
140 mm

- 17-123** 3 mm
- 17-124** 4 mm
- 17-125** 5 mm
- 17-126** 6 mm

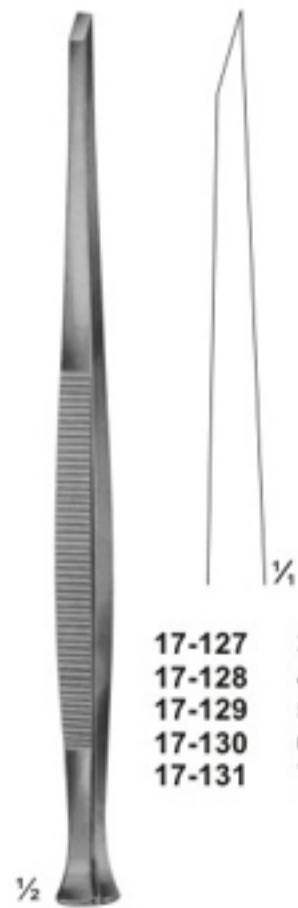

PARTSCH
17-127 - 131
Chisels
170 mm

- 17-127** 3 mm
- 17-128** 4 mm
- 17-129** 5 mm
- 17-130** 6 mm
- 17-131** 7 mm

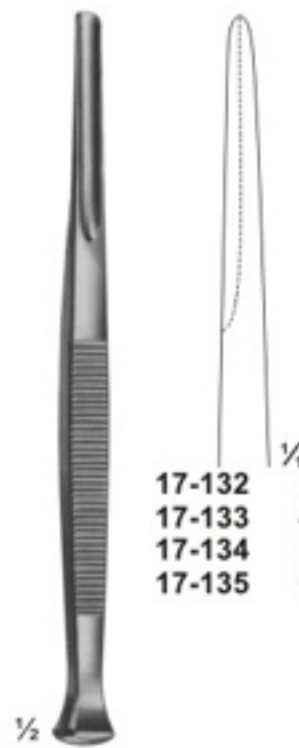

PARTSCH
17-132 - 135
Gouges
140 mm

- 17-132** 3 mm
- 17-133** 4 mm
- 17-134** 5 mm
- 17-135** 6 mm



PARTSCH
17-136 - 140
Gouges
170 mm

- 17-136** 3 mm
- 17-137** 4 mm
- 17-138** 5 mm
- 17-139** 6 mm
- 17-140** 7 mm



LUCAS
17-141 - 142
Chisels
160 mm

- 17-141** 4 mm
- 17-142** 6 mm

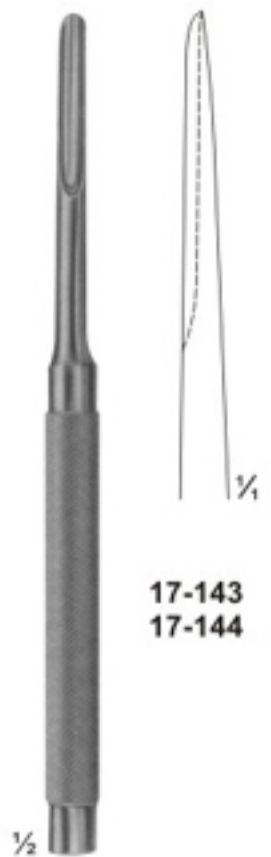

LUCAS
17-143 - 144
Gouges
160 mm

- 17-143** 3 mm
- 17-144** 5 mm

Reposition Forceps, Bone Holding Forceps



17-145
Patella forceps
185 mm



17-146
Forceps with
ratchet fixation
140 mm



17-147
Forceps with
thread fixation
170 mm



17-148
Forceps with
thread fixation
235 mm

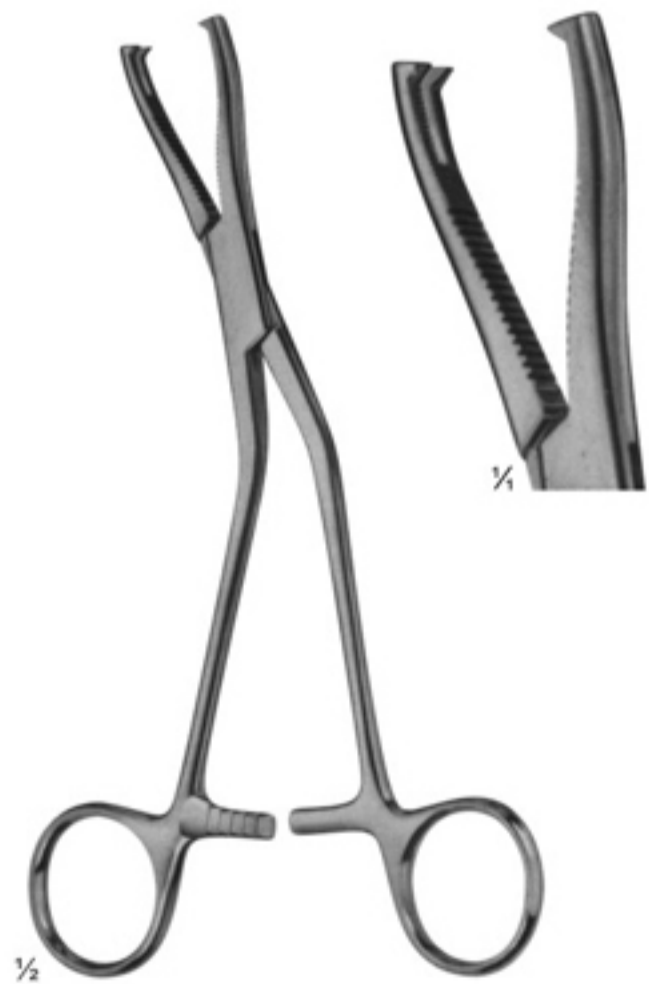

17-149
DINGMANN
185 mm

Bone Holding Forceps & Bone Clamps



17-154 - 155
LOWMAN
17-154 170 mm
17-155 205 mm



17-156
LOWMAN-GERSTER
210 mm



17-157
LOWMAN-HOGLUND
175 mm

Bone Rongeurs



17-158
LUER
150 mm



17-159
LUER
155 mm



17-160
BLUMENTHAL
155 mm



17-161
BLUMENTHAL
150 mm



17-162 - 163
JANSEN
175 mm

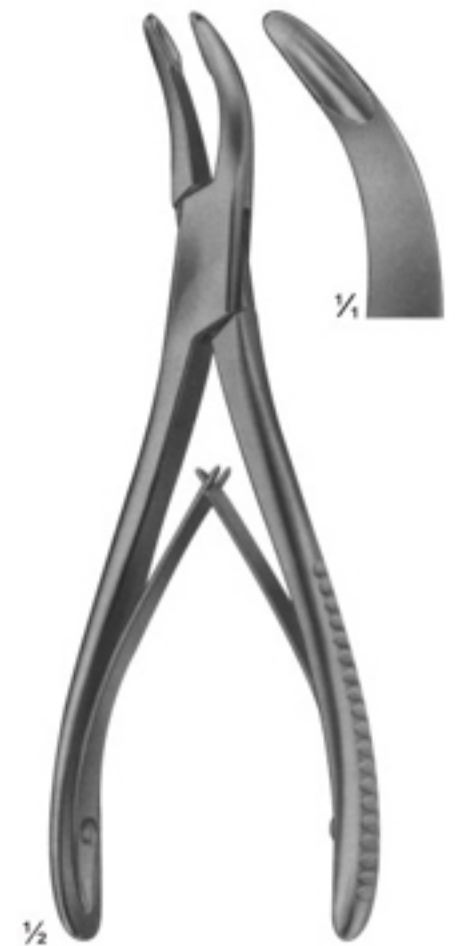

17-164
BANE-HARTMANN
175 mm

Bone Rongeurs



17-165
STILLE
235 mm



17-166
LEKSELL-STILLE
240mm



17-167
STILLE-RUSKIN
240mm

Bone Cutting Forceps

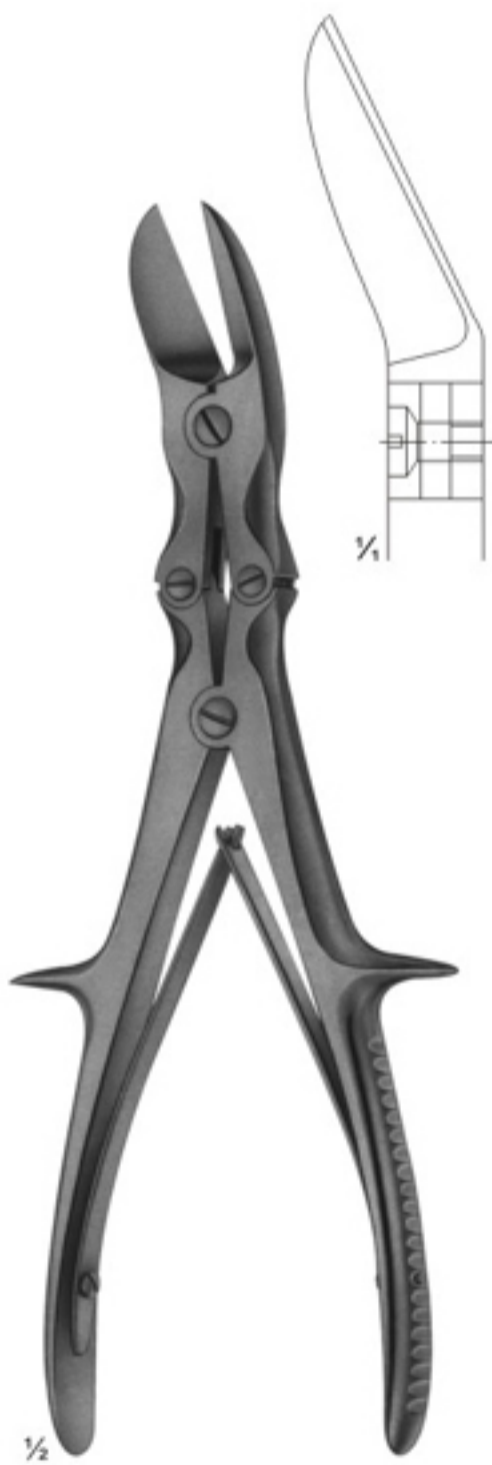

17-168
LISTON
curved on flat
240 mm



17-169
LISTON
straight
280 mm

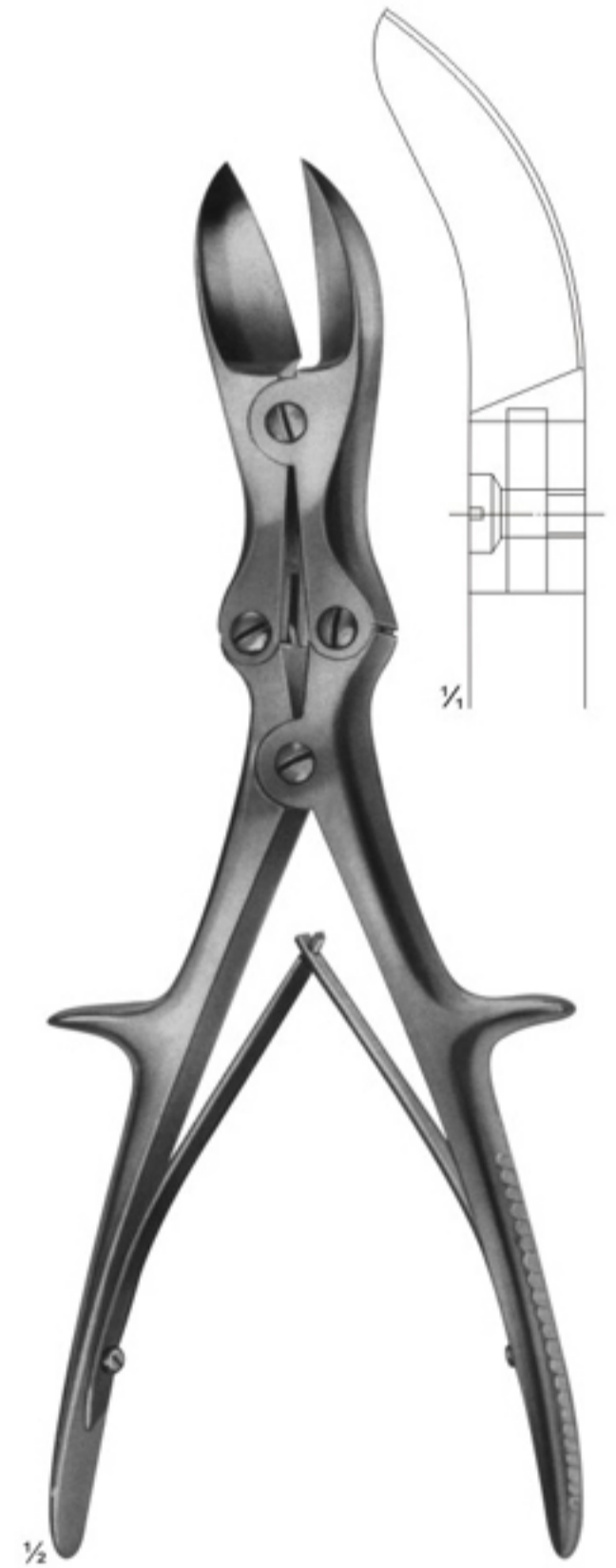

17-170
LISTON
curved on flat
280 mm

Wire Extension

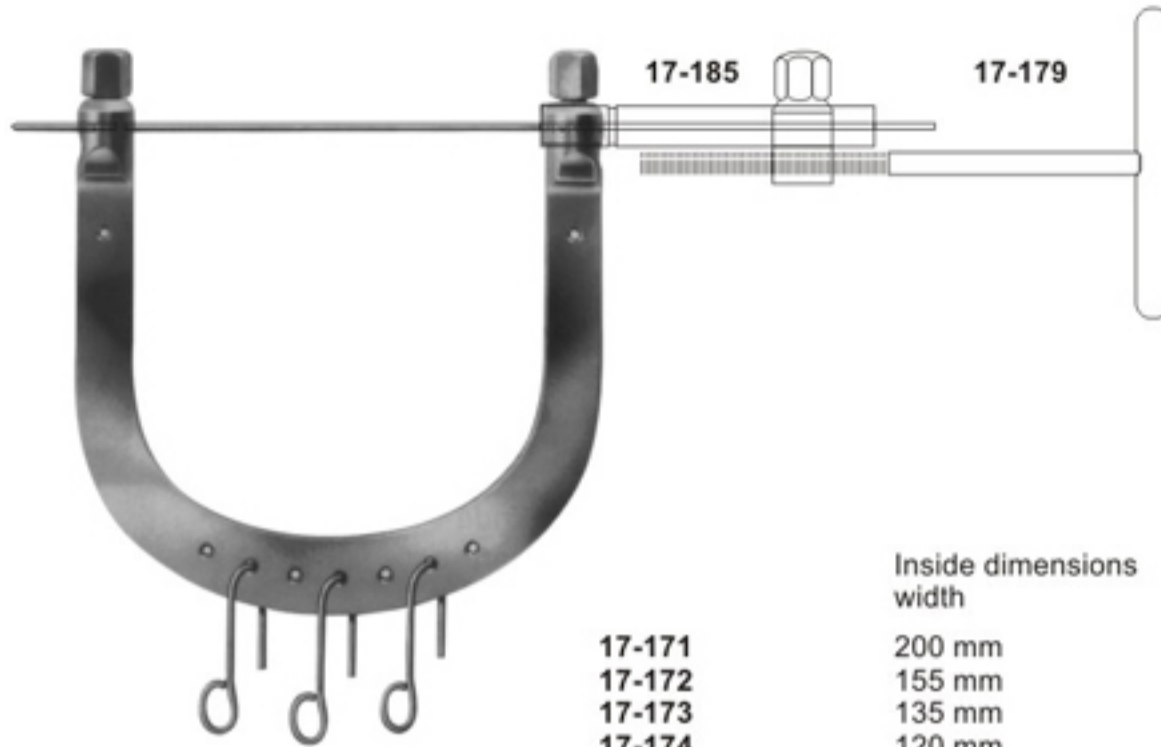

17-171 - 17-177
KIRSCHNER
Wire traction bows,
to be used with
KIRSCHNER-wires
up to 2.5 mm diam.,
With 3 hooks,
stainless steel

	Inside dimensions width	depth	
17-171	200 mm	155 mm	for the hip
17-172	155 mm	155 mm	for the femur
17-173	135 mm	130 mm	for the knee
17-174	120 mm	120 mm	for the knee
17-175	105 mm	100 mm	for the knee
17-176	95 mm	110 mm	for the calcaneus
17-177	95 mm	70 mm	for the arm and elbow



17-178
Wrench, double - ended,
for wire traction bows



17-179
Wire tightener, with
clamping jaws



17-182	max. 105 mm
17-183	max. 160 mm
17-184	max. 200 mm
17-182	80-95 mm
17-183	90-120 mm
17-184	140-170 mm
diam upto	
17-182	1,6 mm
17-183	2,0 mm
17-184	2,5 mm

17-182 - 17-184
KIRSCHNER
Wire traction bows, modified,
adjustable in width, holds wire
securely, with 1 hook



17-180
Traction hook only,
large size



17-181
Traction hook only,
small size



17-185
Fixation clamp, to secure clamping
jaws of 17-179 stainless steel

Cerclage Instruments

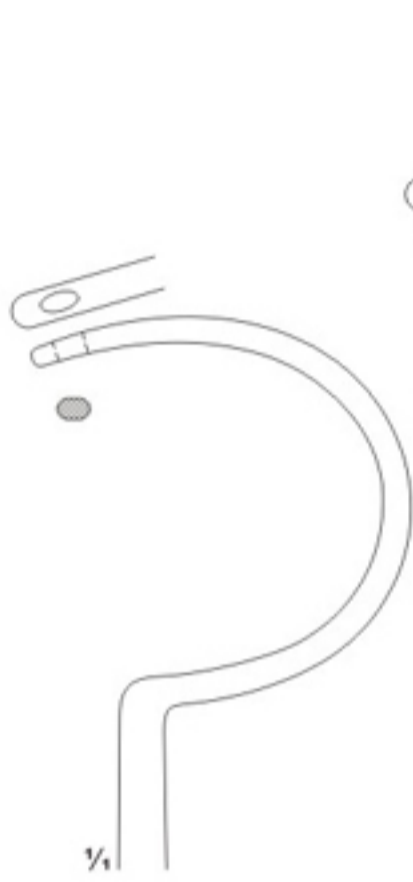

17-186
275 mm

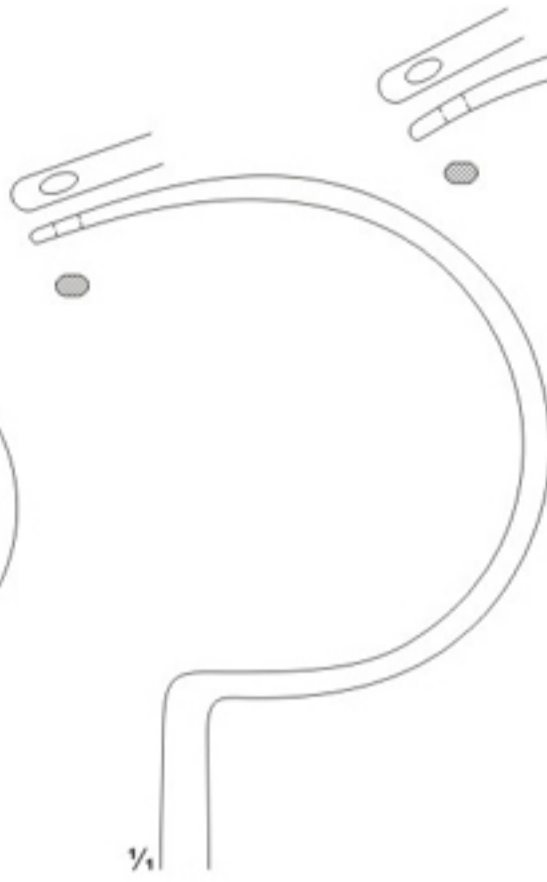

17-187
285 mm



17-188
305 mm



17-186 - 17-188
DEMEL
Wire guides

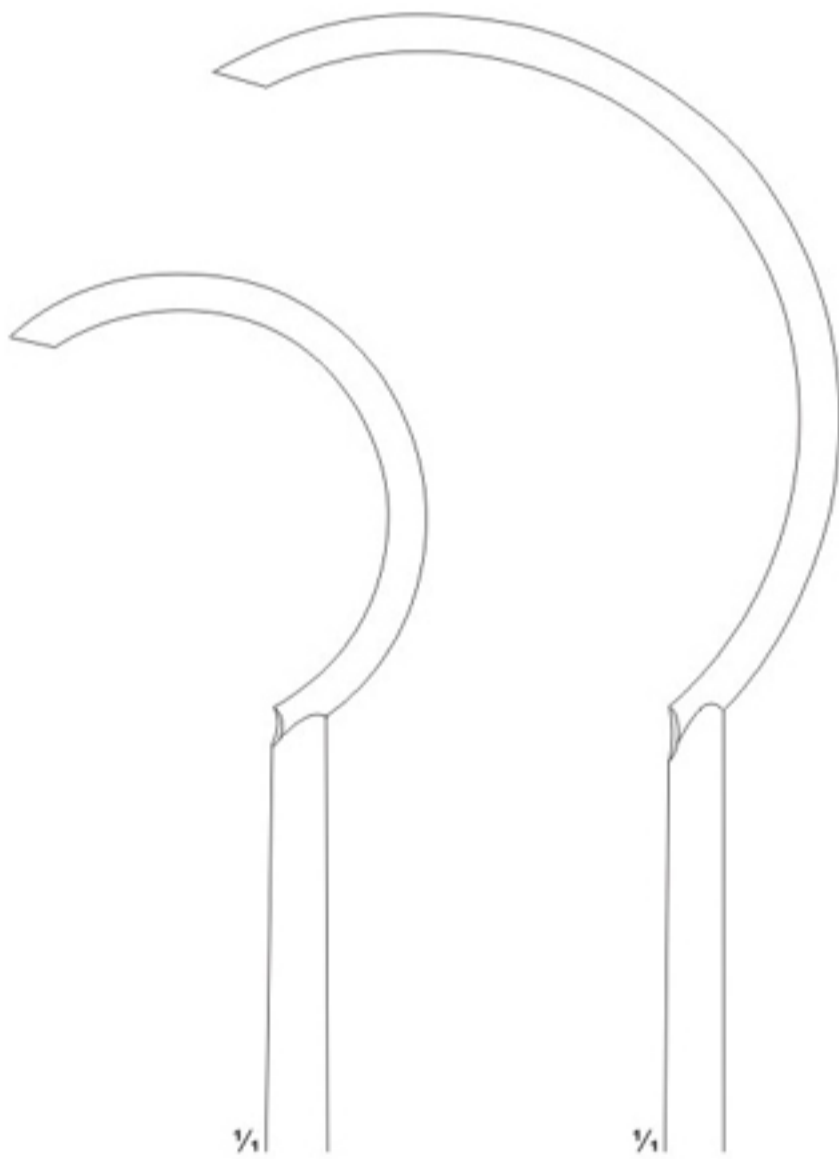

17-189
240 mm



17-190
270 mm

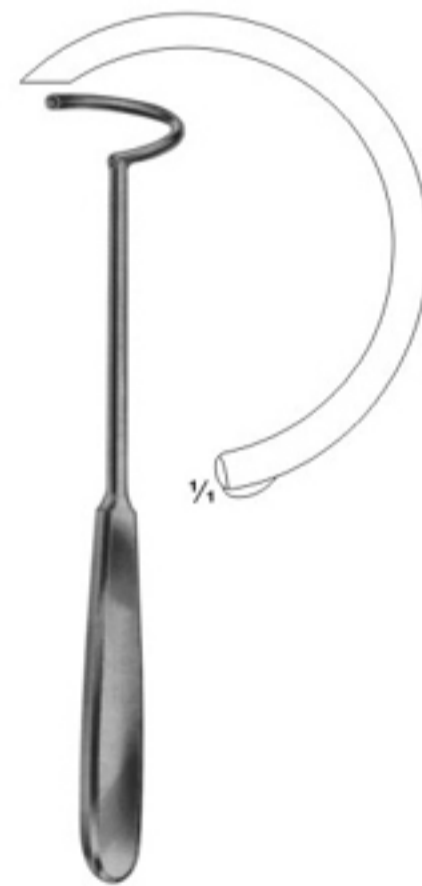

17-191
225 mm

Wire Holding forceps, Wire Tightening Pliers, Flat-nosed Pliers DUROGRIP with Hard Metal Inserts



17-192
DUROGRIP
Holding forceps for cerclage wire, with lateral jaws to avoid wire slipping off
170 mm



17-193
DUROGRIP
Wire, tightening pliers, Ligature pliers
150 mm



17-194
DUROGRIP
Wire, tightening pliers, Ligature pliers
150 mm



17-195
with serrated jaws
140 mm



17-196
one jaw smooth, one jaw serrated
140 mm



17-197
with serrated jaws
17-198
with longitudinal and transversal grooves
170 mm



17-199
190 mm

**Wire Holding forceps, Flat-nosed Pliers,
Pliers for bending and cutting wires**

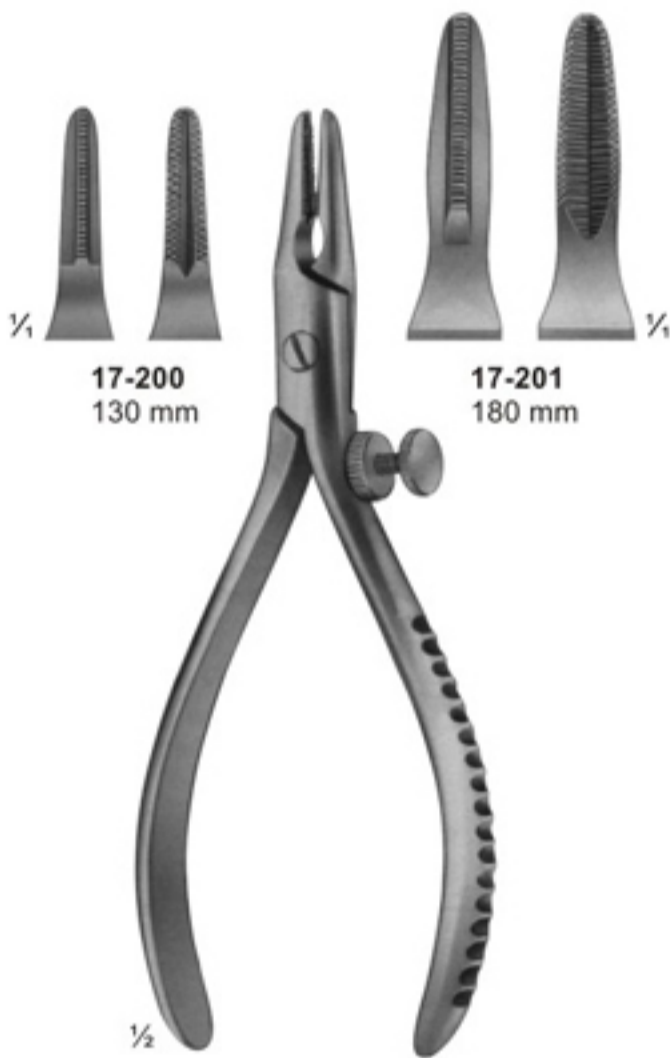

17-200
130 mm

17-201
180 mm

17-200 - 17-201
Extraction pliers
for boring wires



17-202
Flat-nosed pliers,
parallel
185 mm

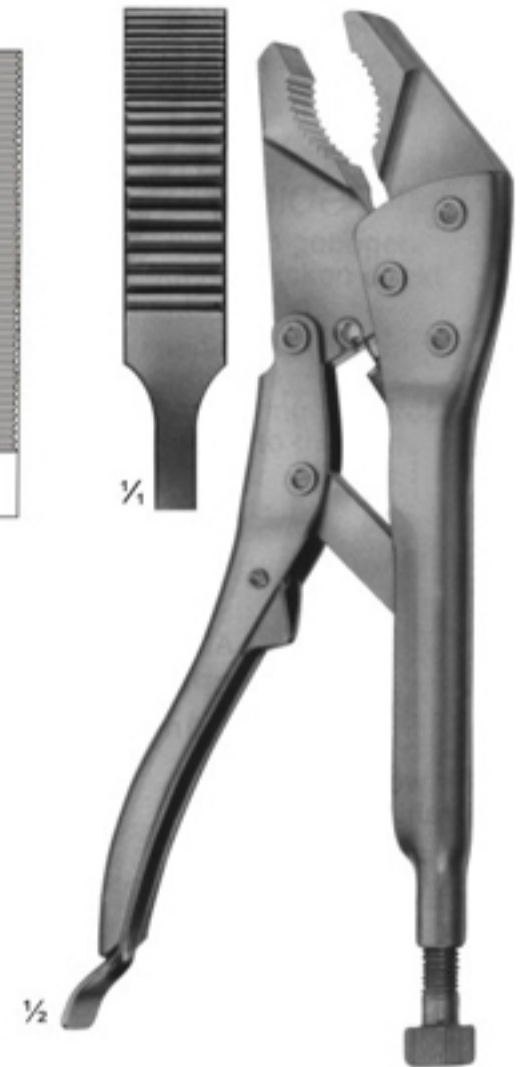

17-203
Vise grip
200 mm

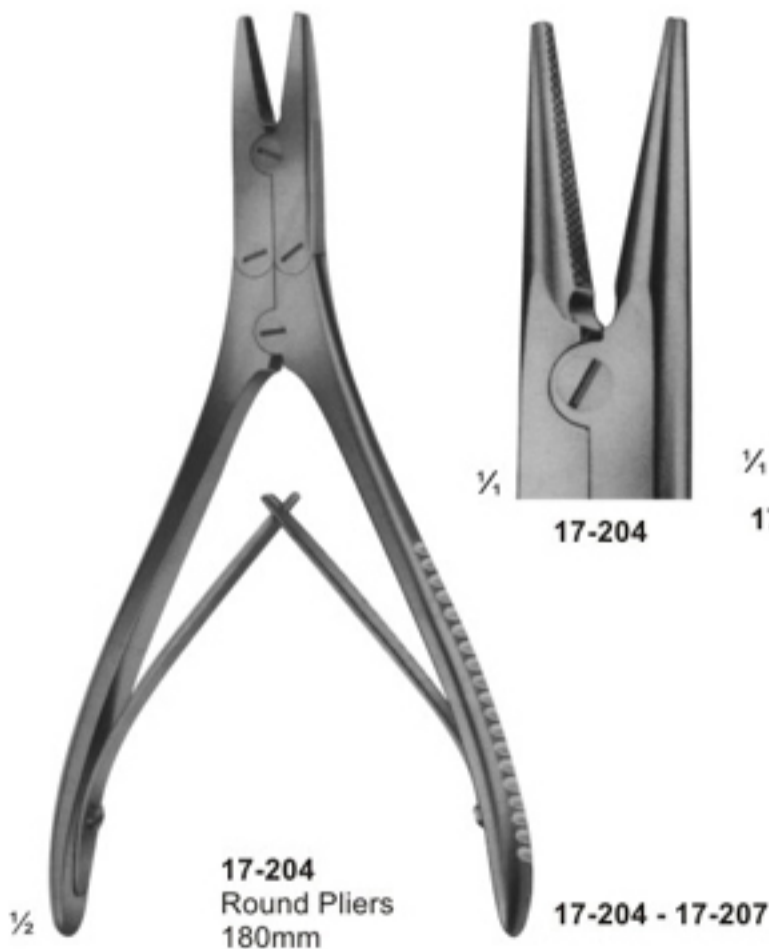

17-204
Round Pliers
180mm

17-204 - 17-207

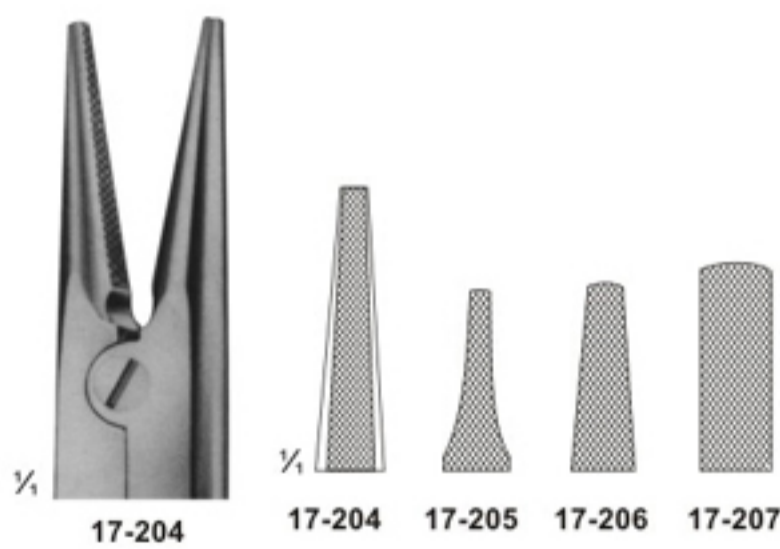

17-205 145 mm
17-206 180 mm
17-207 180 mm
Extraction pliers for wires



17-208
Bending pliers
for wires up to
1.8 mm diam.

Wire Cutters and wire Cutting Scissors DUROTIP with Carbide Cutting Edges



17-209
ANGLE
130 mm

for soft wire
up to diam.
for hard wire
up to diam.

0,5 mm
0,3 mm

17-210
DUROTIP
ANGLE
130 mm

0,6 mm
0,4 mm

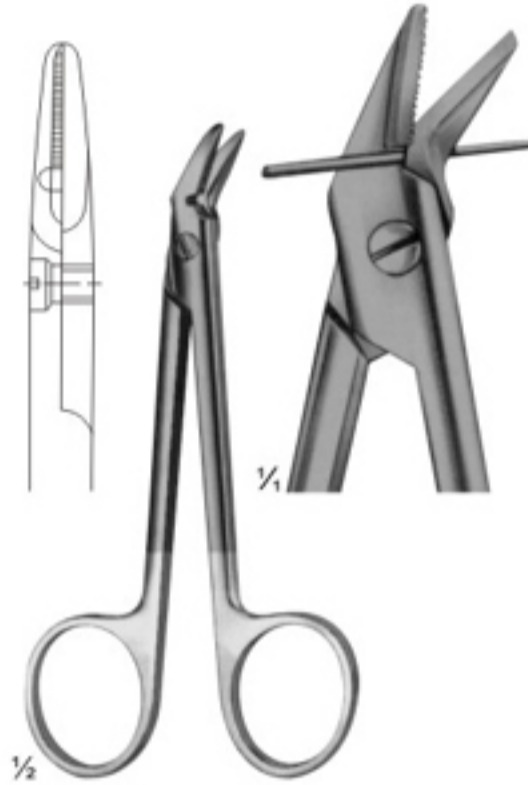

17-211
120 mm

for soft wire
up to diam.
for hard wire
up to diam.

1,2 mm
0,8 mm

17-212
DUROTIP
120 mm

1,2 mm
0,8 mm

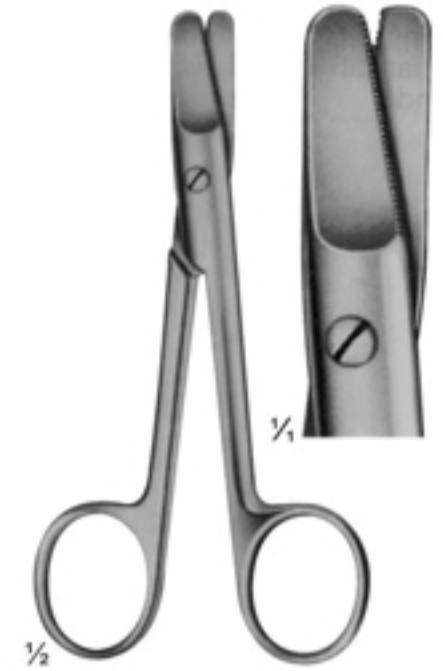

17-213
HARVEY
125 mm

0,4 mm
0,3 mm



17-214
150 mm

for soft wire
up to diam
for hard wire
up to diam

1,5 mm
1,0 mm



17-215
160 mm

1,5 mm
1,2 mm



17-216
140 mm
DUROTIP
1,5 mm

1,0 mm

Wire Cutting Pliers, Lateral Cutting Action



17-217
180 mm

for soft wire
 up to diam. 2,0 mm
 For hard wire 1,5 mm
 up to diam
 specially hardened
 cutting edges, front
 and lateral cutting
 action



17-218
REILL
175 mm

for soft wire
 up to diam. 2,0 mm
 For hard wire 1,6 mm
 up to diam
 specially hardened
 cutting edges, for
 cutting off wires close
 to the bone



DUROTIP

17-219
235 mm

for soft wire
 up to diam. 3,0 mm
 For hard wire 2,2 mm
 up to diam

Wire Cutting Pliers, Lateral and Front Cutting Action



17-220
240 mm

for soft wire up to diam. 2,0 mm
For hard wire up to diam. 1,6 mm



17-221
145 mm

for soft wire up to diam. 1,5 mm
For hard wire up to diam. 1,0 mm



17-222
145 mm

for soft wire up to diam. 2,0 mm
For hard wire up to diam. 1,5 mm



17-223
220 mm

for soft wire up to diam. 3,5 mm
For hard wire up to diam. 2,5 mm

Wire Cutting Pliers



17-224
320 mm

for soft wire
up to diam. 3,0 mm
For hard wire
up to diam 3,0 mm

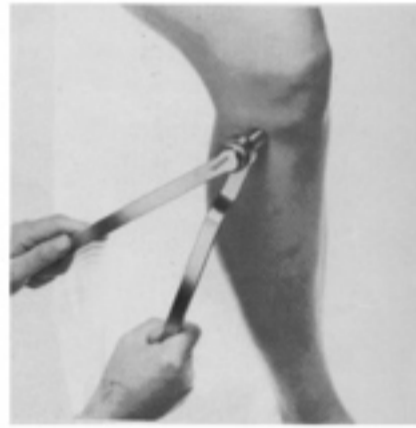

Cutter for cutting off
KIRSCHNER wires,
Tibia head screws,
bolts, pins, up to 3 mm diam.



DUROTIP

17-225
Cutter for cutting off
KIRSCHNER wires,
Tibia head screws,
bolts, pins, up to 6 mm diam.
470 mm

Finger Nail Instruments

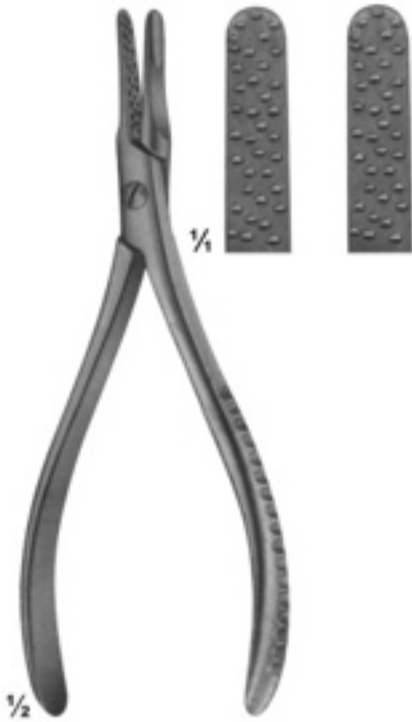

17-226
Nail extracting
forceps
135 mm



17-227
Nail extracting
forceps
145 mm



17-228
Finger nail drill
with 3 drill points

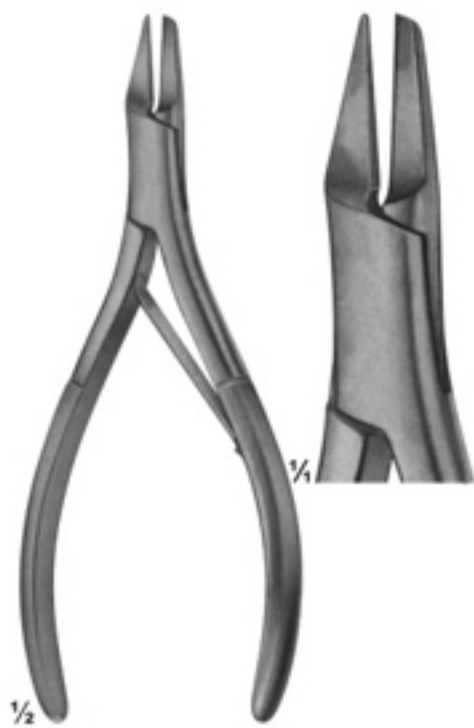

17-231
Nail splitting
forceps
135 mm



17-232
SYSTRUNK
Scissors, for splitting
finger nails
130 mm



17-233
Finger ring saw
150 mm

Plaster Shears



17-235
STILLE-AESCLAP
260 mm



17-236
STILLE-AESCLAP
360 mm

Plaster Spreader, Plaster Breakers



17-237
HENING
270 mm



17-238
MOD.USA
230 mm



17-239
290 mm



with removable jaws



17-240 - 17-241
WOLFF
17-240 180 mm
17-241 240 mm
plaster breakers

Vacuum Currettes for Aspiration Lipectomy, Suction Instruments

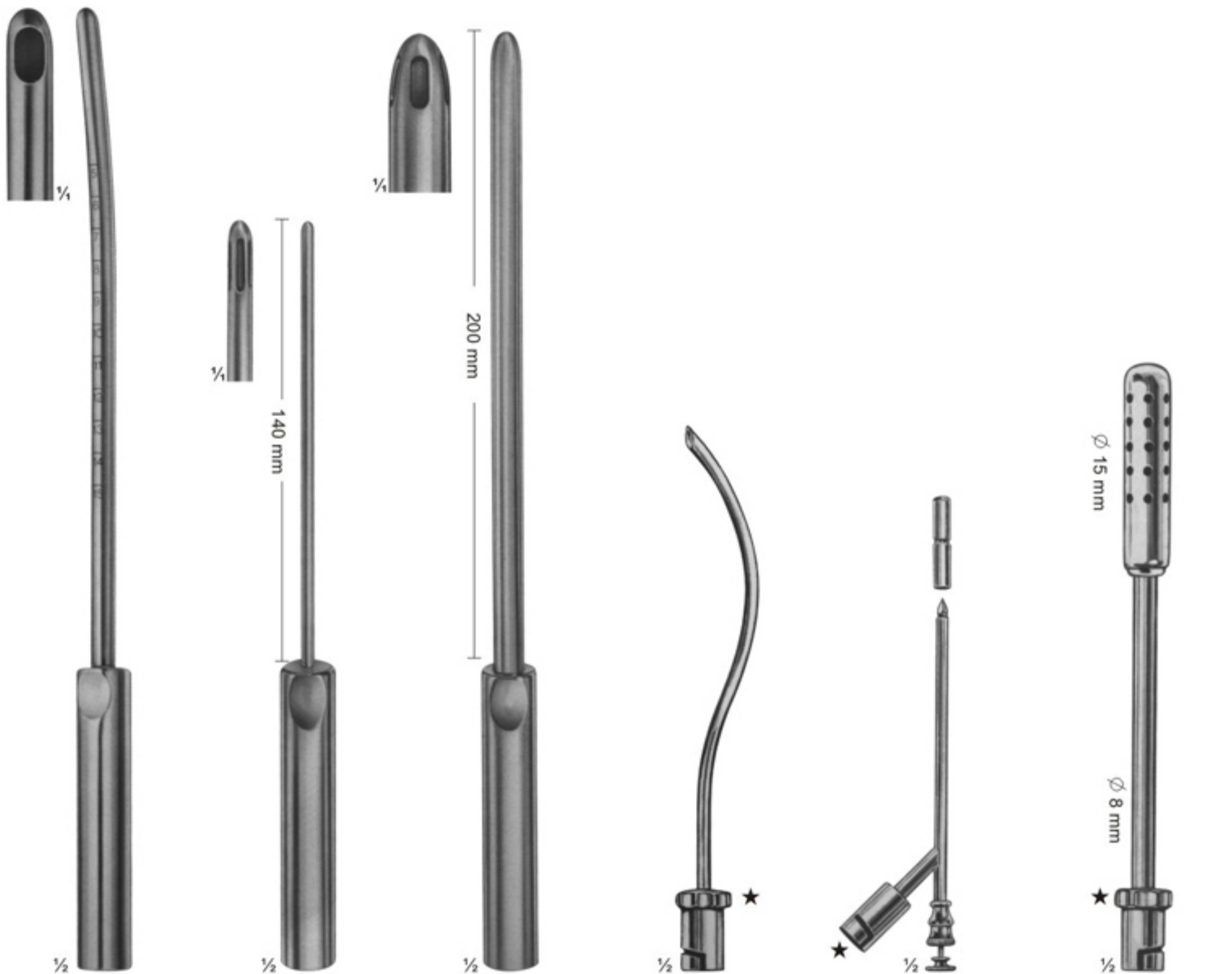

18-101 - 18-106
BIEMER
18-101 \varnothing 4 mm
18-102 \varnothing 6 mm
18-103 \varnothing 8 mm
18-104 \varnothing 10 mm
18-105 \varnothing 12 mm
18-106 \varnothing 14 mm
Currettes for aspiration lipectomy, graduated, slightly curved

18-107 - 18-108
BIEMER
18-107 \varnothing 4 mm
18-108 \varnothing 6 mm
Currettes for aspiration lipectomy, with three apertures, slightly curved malleable

18-109 - 18-111
BIEMER
18-109 \varnothing 8 mm
18-110 \varnothing 10 mm
18-111 \varnothing 12 mm
Currettes for aspiration lipectomy, with three apertures, slightly curved malleable

18-112
For aspirating fluid from the excretory ducts of large glands and for keeping the operating area clear
170 mm

18-113
Trocar
For puncturing
150 mm

18-114
For clearing large quantities of fluid
190 mm

Suction Instruments

18-115 150mm
Suction handle, with vacuum regulator and finger cut-off, brass, mirror-finish chromium-plated

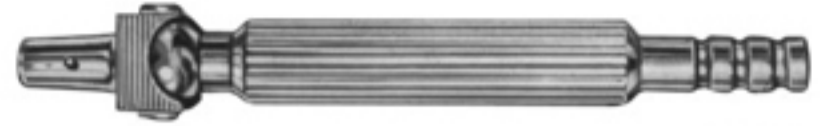

olive
Ø 9 mm

18-116 170mm
Suction handle, with hand regulation valve and quick-shutter, brass, mirror-finish chromium-plated



Both suction handles have bayonet fitting Olive and can be used for the suction cannulae. Ø 9 mm



18-117
Trocar
For puncturing
170 mm



18-118
Hollow needle,
sharp
150 mm



18-119
double curved
For general
surgery
230 mm



18-120
For tonsillectomy,
oral and laryngeal
operations
190 mm



18-121
For tonsillectomy,
oral and laryngeal
operations
220 mm

★ With bayonet fitting to be used with suction handles (18-115 - 18-116)

Suction Instruments

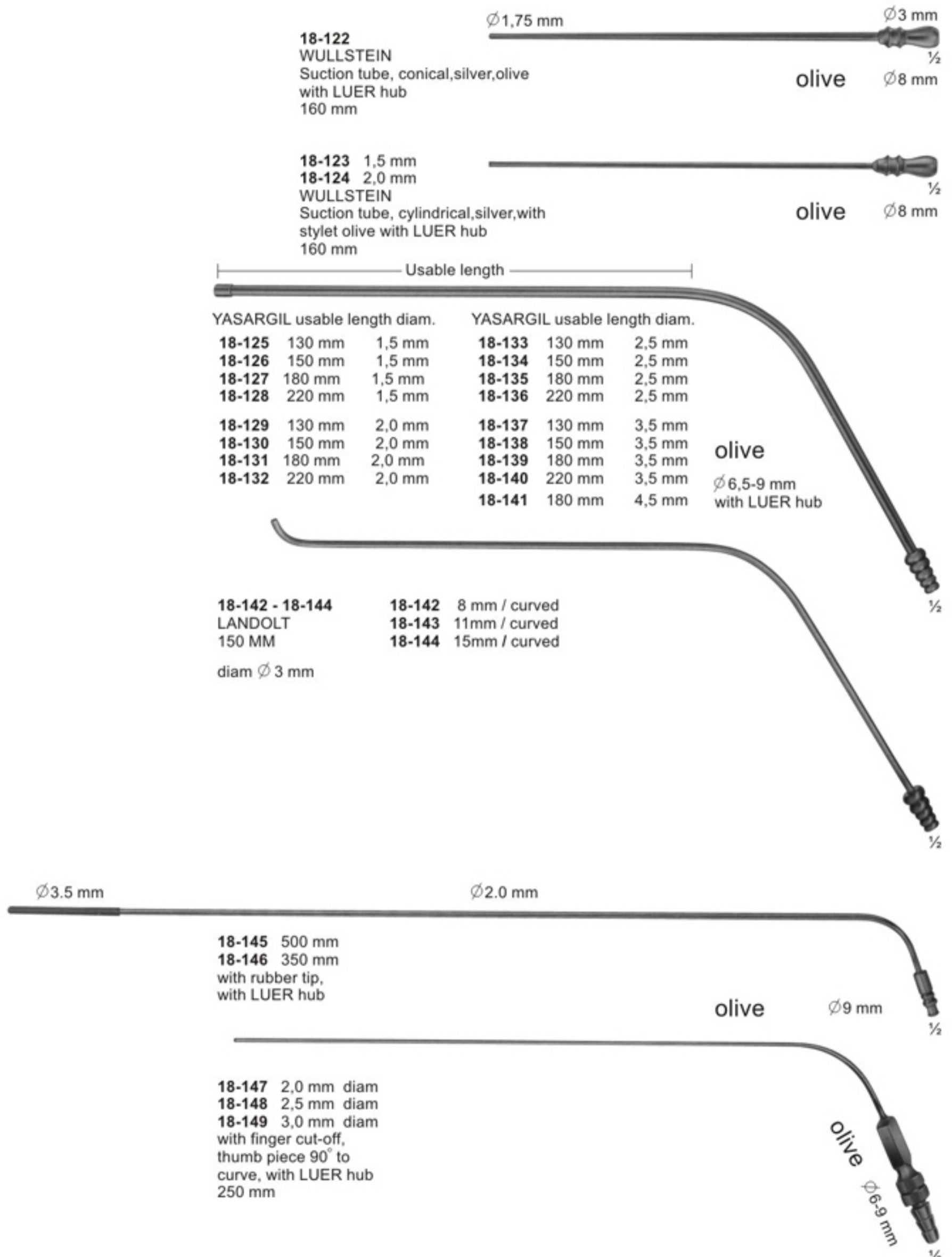

18-122
WULLSTEIN
Suction tube, conical, silver, olive
with LUER hub
160 mm

$\varnothing 1,75$ mm $\varnothing 3$ mm
 $\frac{1}{2}$
olive $\varnothing 8$ mm

18-123 1,5 mm
18-124 2,0 mm
WULLSTEIN
Suction tube, cylindrical, silver, with
stylet olive with LUER hub
160 mm

olive $\varnothing 8$ mm
 $\frac{1}{2}$

Usable length

YASARGIL usable length diam.		YASARGIL usable length diam.	
18-125	130 mm 1,5 mm	18-133	130 mm 2,5 mm
18-126	150 mm 1,5 mm	18-134	150 mm 2,5 mm
18-127	180 mm 1,5 mm	18-135	180 mm 2,5 mm
18-128	220 mm 1,5 mm	18-136	220 mm 2,5 mm
18-129	130 mm 2,0 mm	18-137	130 mm 3,5 mm
18-130	150 mm 2,0 mm	18-138	150 mm 3,5 mm
18-131	180 mm 2,0 mm	18-139	180 mm 3,5 mm
18-132	220 mm 2,0 mm	18-140	220 mm 3,5 mm
		18-141	180 mm 4,5 mm

olive
 $\varnothing 6,5-9$ mm
with LUER hub
 $\frac{1}{2}$

18-142 - 18-144
LANDOLT
150 MM
diam $\varnothing 3$ mm

18-142 8 mm / curved
18-143 11mm / curved
18-144 15mm / curved

$\varnothing 3,5$ mm $\varnothing 2,0$ mm

18-145 500 mm
18-146 350 mm
with rubber tip,
with LUER hub

olive $\varnothing 9$ mm
 $\frac{1}{2}$

18-147 2,0 mm diam
18-148 2,5 mm diam
18-149 3,0 mm diam
with finger cut-off,
thumb piece 90° to
curve, with LUER hub
250 mm

olive $\varnothing 6-9$ mm
 $\frac{1}{2}$

Combined Suction and Irrigation Cannulae, Coagulation Suction Cannulae

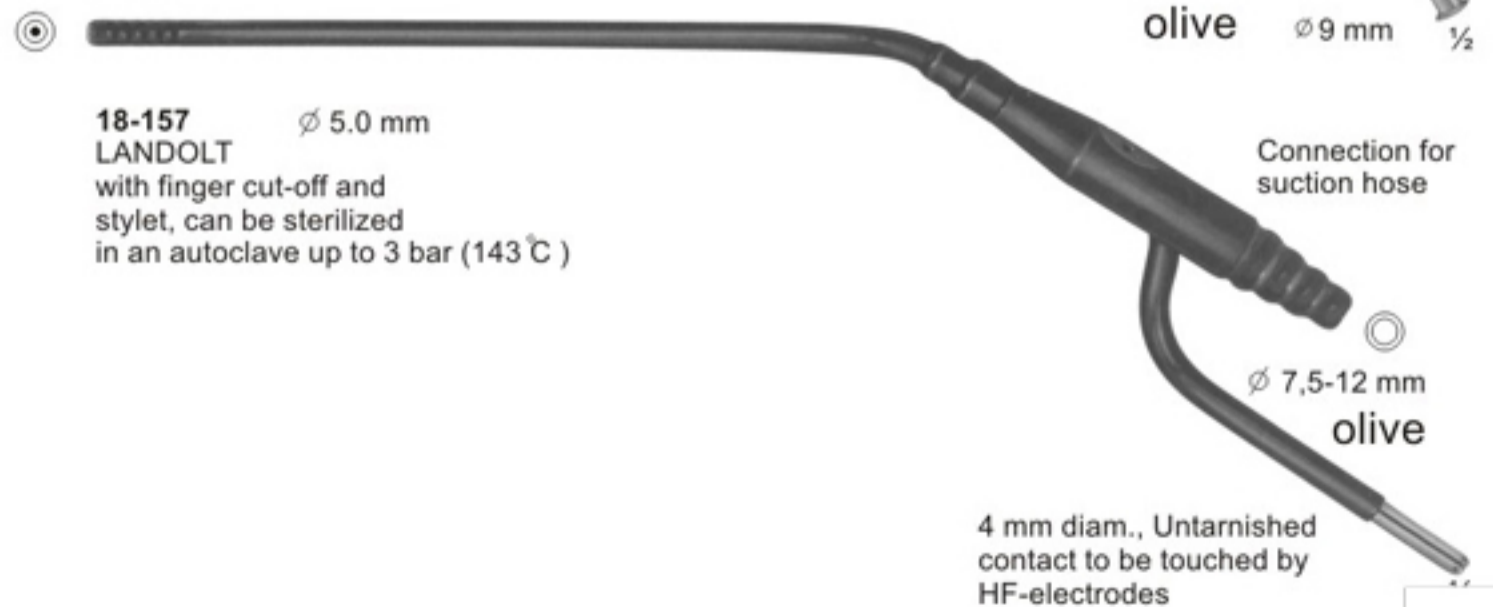
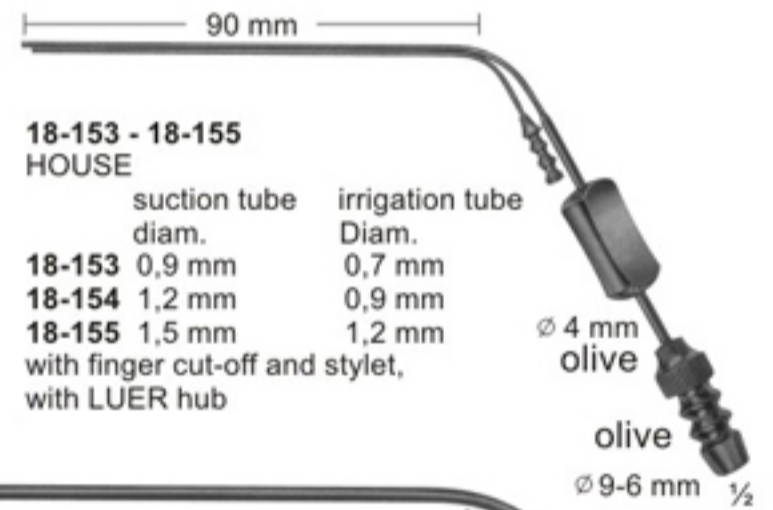
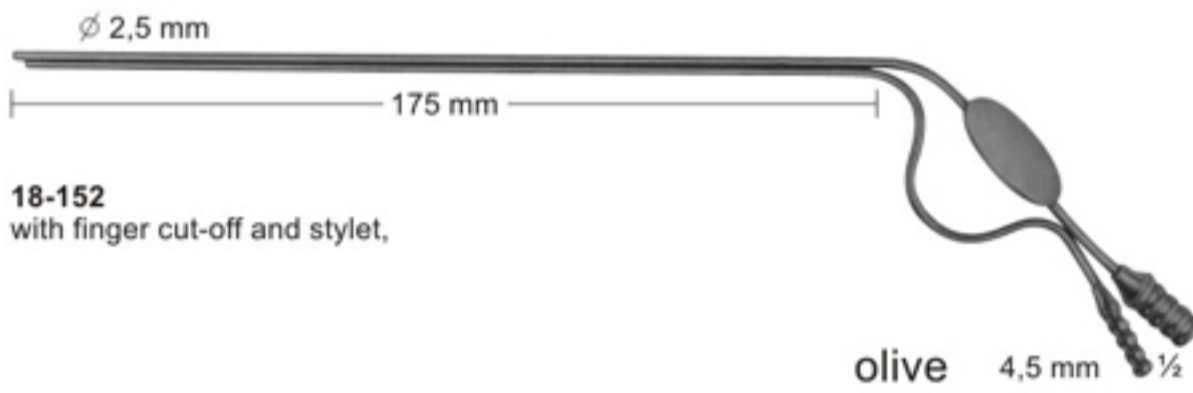
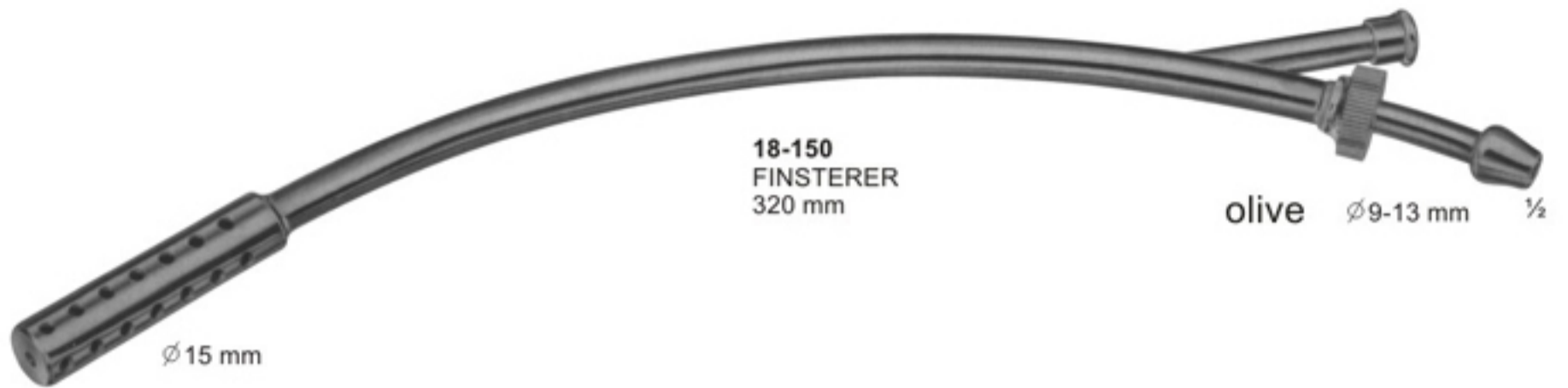

Suction Instruments

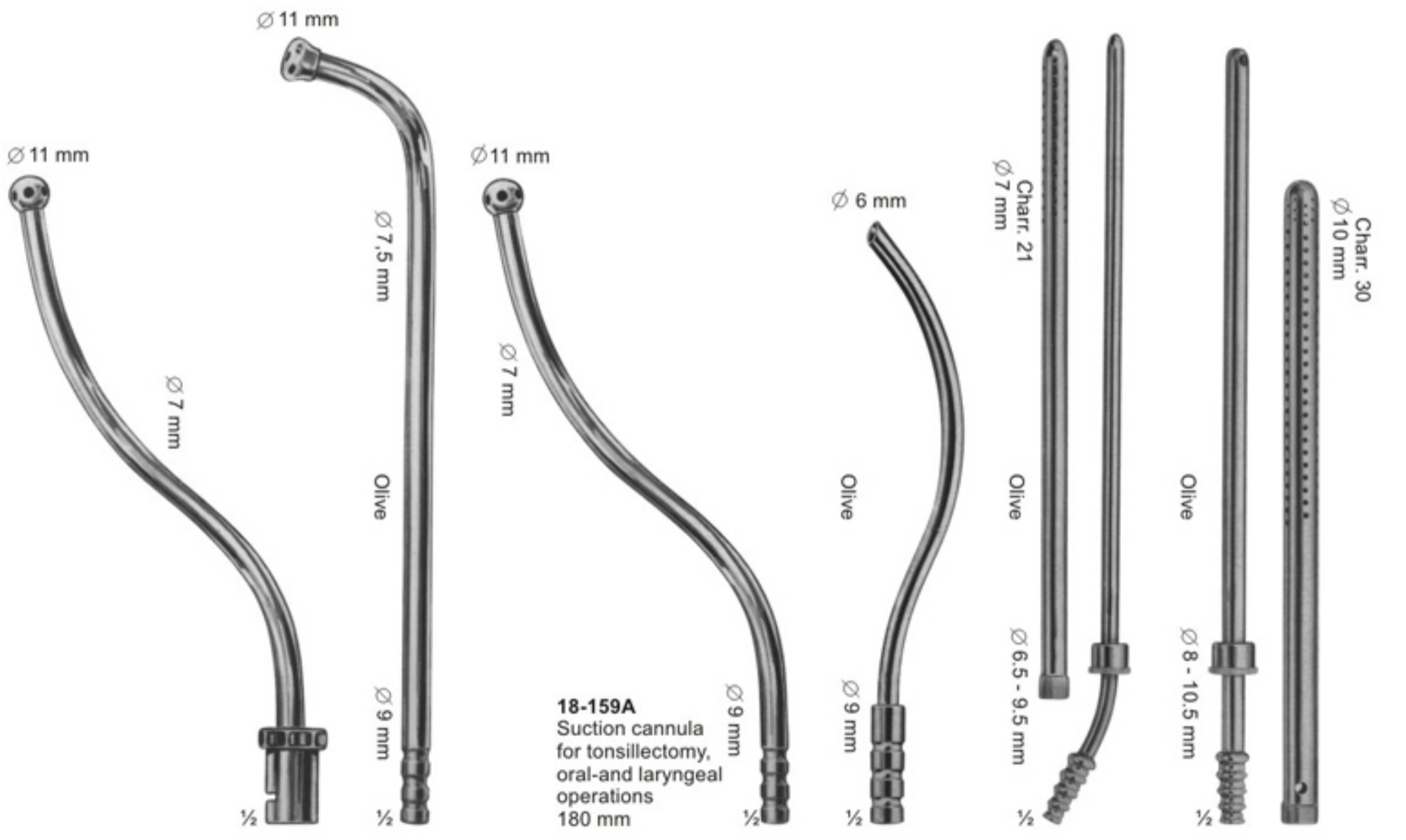

18-158
For tonsillectomy,
oral-and laryngeal
operations
180 mm

18-159
Suction cannula
for tonsillectomy,
oral-and laryngeal
operations
220 mm

18-159A
Suction cannula
for tonsillectomy,
oral-and laryngeal
operations
180 mm

18-160
S-shaped blunt cannula
for aspirating fluid from
the excretory ducts of
large glands and for
keeping the operating
area clear
170 mm

18-161
POOL
Suction cannula,
with outer tube
to be screwed of
225 mm

18-162
POOL
Suction cannula,
with outer tube
to be screwed off
225 mm

Suction Instruments

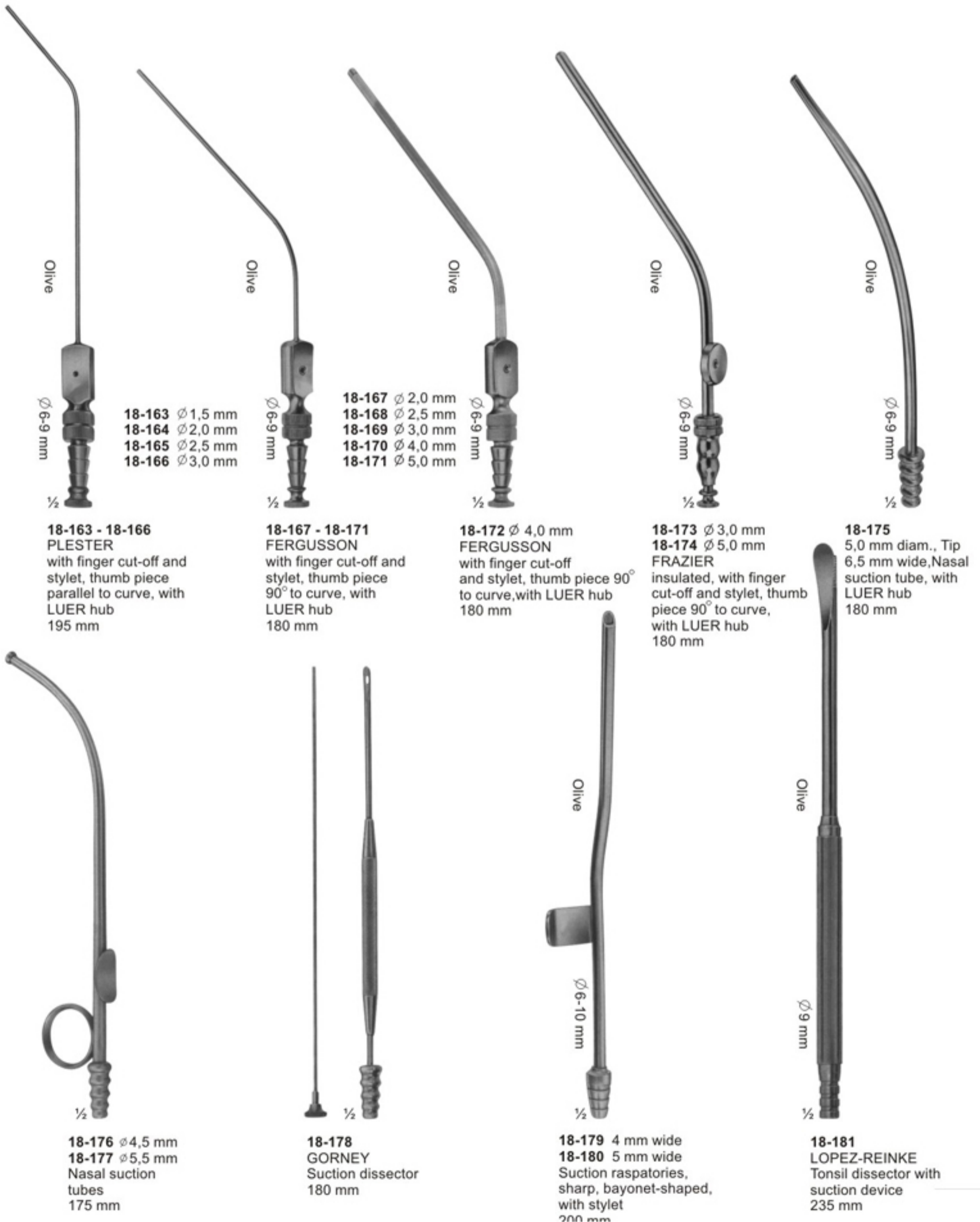

Dissection Instruments

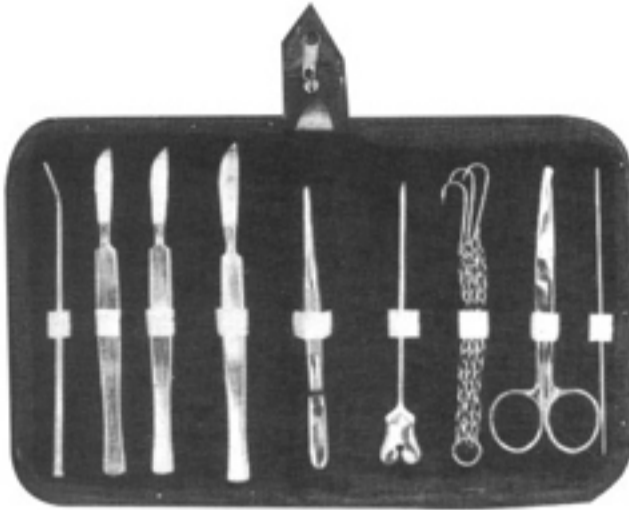
18-182

- 1- Blow pipe .
- 2- 3 PCS .scalpel.
- 3- Dissecting forcep 13 cm.
- 4- Grooved director with tounge tie 13 cm.
- 5- Triple chain hook.
- 6- Dressing scissors probe pointed 13 cm.
- 7- Probe double 13 cm.
- 8- Zipper case inside red velvet.

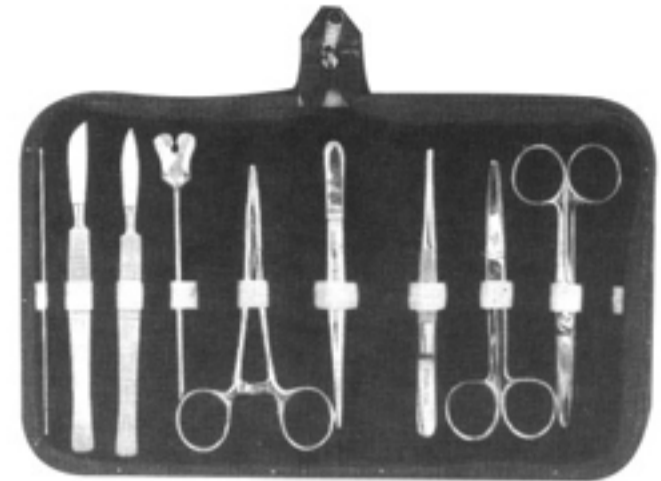
18-183

- 1- Probe Double 13 cm
- 2- 2 PCS. Scalpel S.S
- 3- Grooved Director With tongue Tie 13 cm
- 4- Mayo Hegar Needle Holder 13cm
- 5- Discting Forcep 13 cm 1x2 Teeth
- 6- Dressing Forcep 13 CMS Serrated.
- 7- Dressing Scissor 13 cm S/B STR.
- 8- Dressing Scissor 13 cm S/B CVD.
- 9- Zipper Case Inside Red Velvet.

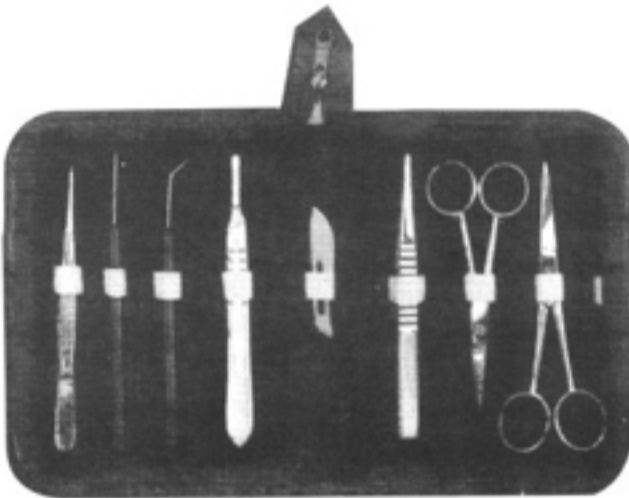
18-184

- 1- Dissecting Forcep 11.5 cm Sharp Point.
- 2- Iris Scissor
- 3- B.P Handle No. 4
- 4- Teasing Needle Sharp angular.
- 5- Blade No. 22
- 6- Thumb Forceps T.O.E 13 cm
- 7- Dissecting Scissor STR 11.5 cm
- 8- Dissecting Scissor STR 13 cm
- 9- Zipper case Inside Red Velvet

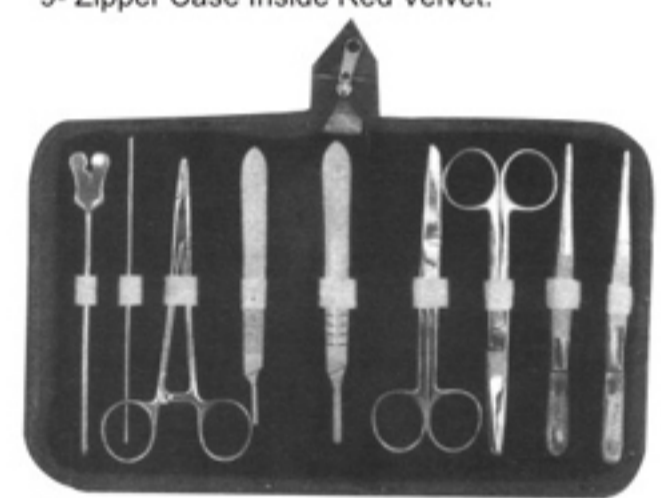
18-185

- 1- Grooved Director with Tongue Tie 14 cm
- 2- Probe Double 14cm
- 3- Mayo Hegar Needle Holder 14 cm
- 4- BP. Handle no.3
- 5- BP. Handle no.4
- 6- Dressing Scissor 14 cm S/B STR
- 7- Dressing Scissor 14 cm S/B CVD.
- 8- Dressing Forcep 1x2 Teeth 14 cm
- 9- Dressing Forcep Serrated 14 cm

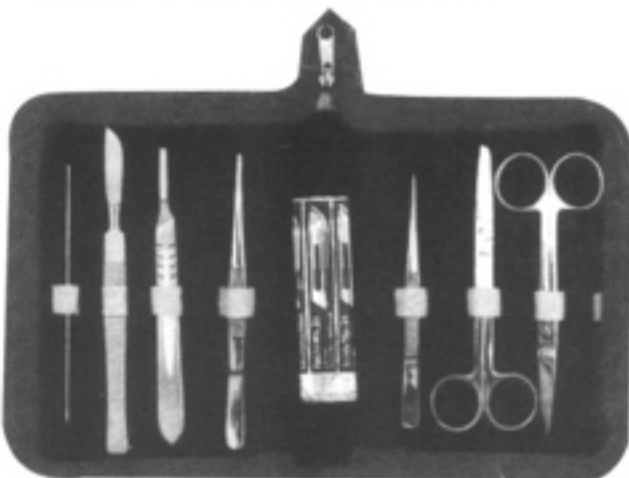
18-186

- 1- Probe double 12.5 cm
- 2- Scalpel
- 3- B.P Handle No. 4
- 4- 6 PCS Blade 2 each no. 21, 22, 23
- 5- Dissecting Forcep 12.5 cm
- 6- Dissecting Forcep 11.5 cm sharp Point
- 7- Dissecting Scissor S/B STR 13 cm
- 8- Dissecting Scissor S/S STR 13 cm

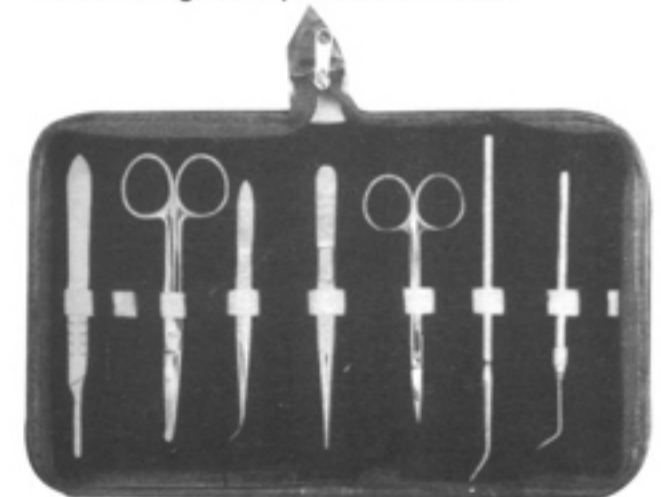
18-187

- 1- Teasing Needle with Chuck CVD.
- 2- Huber Probe
- 3- Iris Scissor
- 4- Dissecting Forcep Fine 14 cm.
- 5- Dissecting Forcep Fine CVD. 12 cm
- 6- Operating Scissor with Probe 14 cm.
- 7- B.P. Handle no. 4

Dissection Instruments



18-188

- 1- Probe with eye
- 2- Dissecting Forcep cvd fine 12 cm.
- 3- Iris Scissor
- 4- Operating Scissor S/B str 14 cm
- 5- Grooved Director and Tongue tie
- 6- Huber Probe
- 7- Triple Chain Hook
- 8- B.P Handle No. 4
- 9- B.P Handle No. 3
- 10- Teasing Needle with Chuck cvd.
- 11- Teasing Needle with Chuck str.
- 12- Dissecting Forceps Fine 14 cm.

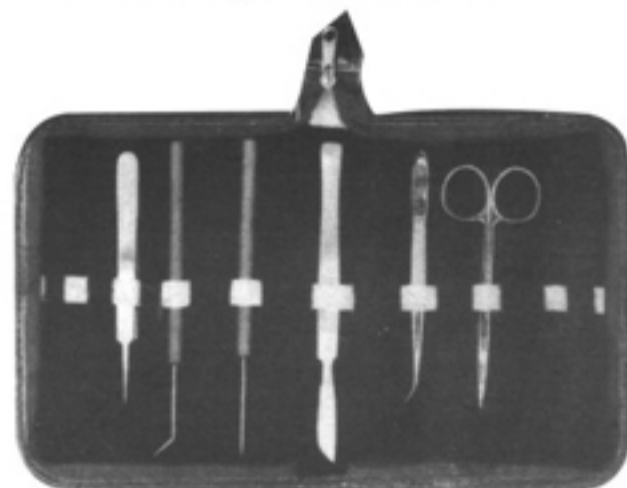

18-190

- 1- Iris Scissor STR
- 2- Dissecting Forceps CVD 12 cm.
- 3- Scalpel
- 4- Teasing Needle STR wooden handle.
- 5- Teasing Needle CVD wooden handle.
- 6- Watchmaker fine point.

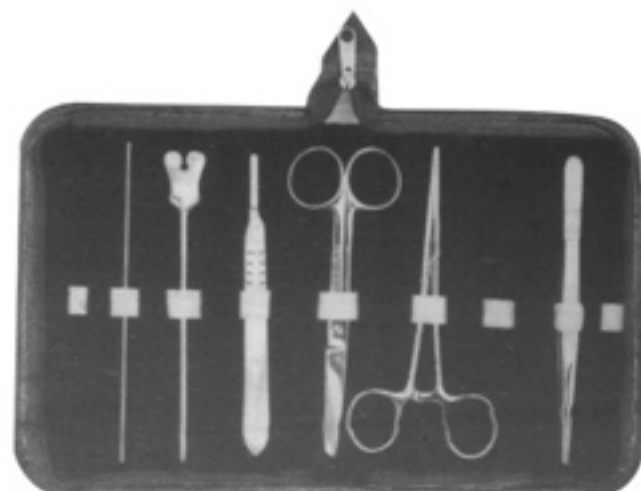

18-192

- 1- Probe double end.
- 2- Grooved director and tounge tie.
- 3- B.P handle no.4
- 4- Operating scissor STR S/b14cm.
- 5- Kelly forceps STR 14cm.
- 6- Dissecting forceps thumb 13cm.

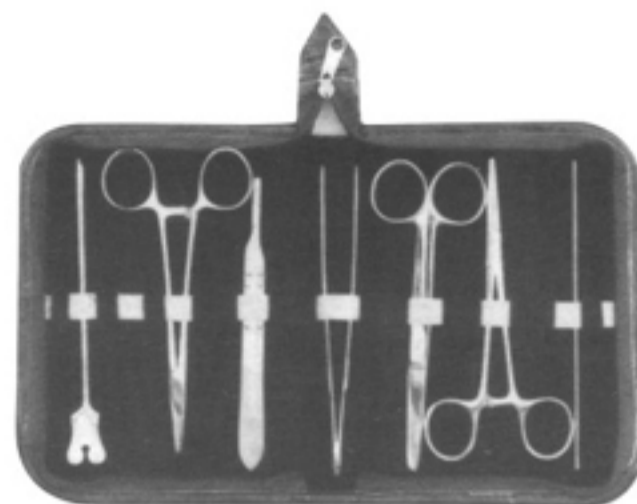

18-189

- 1- Grooved Director and Tongue tie
- 2- Mayo Hearn Needle Holder 14 cm
- 3- B.P Handle No. 4
- 4- Dissecting Forceps Thump 14 cm.
- 5- Operating Scissor S/B str 14 cm
- 6- Kelly Forcep STR 14 cm.
- 7- Probe Double end

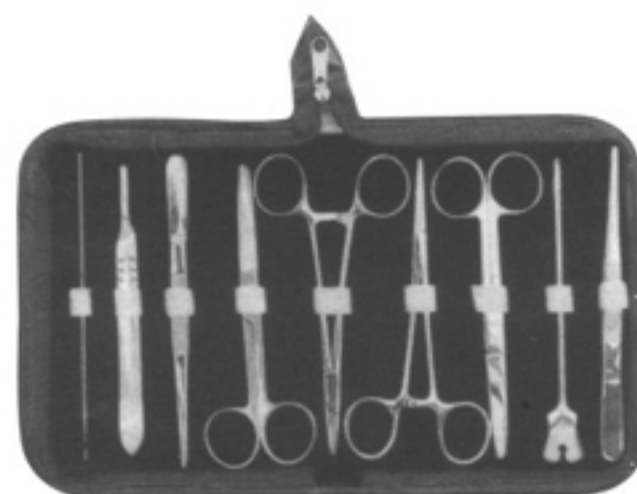

18-191

- 1- Probe Double end
- 2- B.P Handle No. 4
- 3- Dissecting Forcep 1x2 Teeth 14 cm.
- 4- Operating Scissor S/B str 14 cm
- 5- Mayo Hearn Needle Holder 14 cm
- 6- Kelly Forcep STR 14 cm.
- 7- Operating Scissor S/B CVD 14 cm
- 8- Grooved Director and Tongue tie
- 9- Dissecting Forceps Thumb 14 cm.

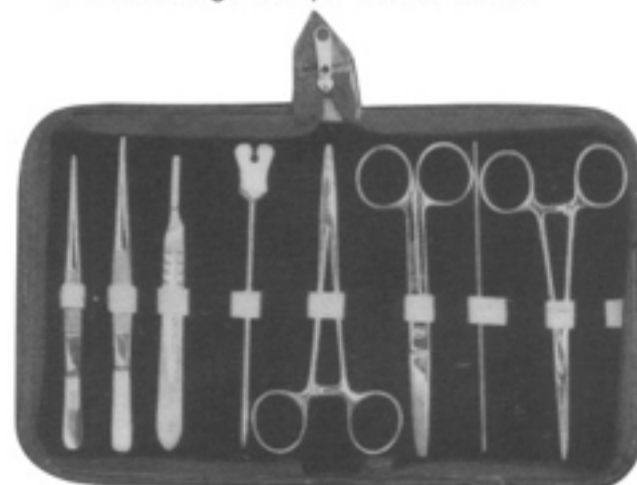

18-193

- 1- Dissecting Forceps Thumb 14 cm
- 2- Dissecting Forcep 1x2 Teeth 14 cm.
- 3- B.P Handle No. 3
- 4- Grooved Director and Tongue tie
- 5- Mayo Hearn Needle Holder 14 cm
- 6- Operating Scissor S/B str 14 cm
- 7- Probe Double end
- 8- Kelly Forcep STR 14 cm.

Dissection Instruments

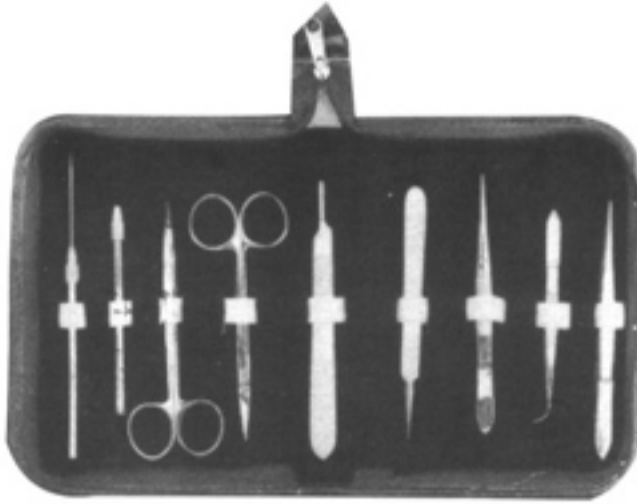
18-194

- 1- Dissecting Forcep Fine 14cm.
- 2- Dissecting Forcep Fine CVD 12cm
- 3- Dissecting Forcep with Pin 14cm.
- 4- Watchmaker Fine point
- 5- Iris scissor STR
- 6- Iris scissor CVD.
- 7- Teasing Needle holder
- 8- Teasing Needle STR.
- 9- B.P. Handle no. 3

18-195

- 1- Teasing Needle STR.
- 2- Grooved Director and Tongue Tie.
- 3- Teasing Needle CVD.
- 4- Dissecting Forcep with Pin 12 cm Fine
- 5- Operating Scissor S/B STR 14 cm
- 6- Triple Chain Hook
- 7- Probe with eye
- 8- Probe Double end
- 9- Probe and Hook
- 10- Dissecting Forcep Fine 14 cm
- 11- Iris Scissor
- 12- Huber Probe
- 13- B.P. Handle no.3
- 14- B.P. Handle no.4

18-196

- 1- Dissecting forcep fine STR with pin 12cm.
- 2- Iris scissor STR.
- 3- Probe with eye.
- 4- Probe and hook.
- 5- Operating scissor S/B STR 14cm
- 6- Triple chain hook.
- 7- B.P. handle no.4
- 8- Humber probe.
- 9- B.P.handle no.3
- 10- Teasing needle STR plastic handle.
- 11- Teasing needle CVD plastic handle.
- 12- Grooved director and tongue tie.
- 13- Probe double end.

18-197

- 1- Dissecting Forceps Thumb 14 cm.
- 2- Dissecting Forcep 1x2 Teeth 14 cm.
- 3- B.P Handle No. 3
- 4- Grooved Director and Tongue tie
- 5- Mayo Hearn Needle Holder 14 cm
- 6- Operating Scissor S/B str 14 cm
- 7- Probe Double end
- 7- Kelly Forcep STR 14 cm.

Hospital Wares



19-101 - 115
Schimmelbusch

	Ø x H sizes in mm
19-101	80 x 80
19-102	105 x 120
19-103	140 x 140
19-104	160 x 120
19-105	160 x 150
19-106	190 x 150
19-107	190 x 190
19-108	240 x 160
19-109	240 x 240
19-110	290 x 160
19-111	290 x 240
19-112	340 x 160
19-113	340 x 340
19-114	390 x 190
19-115	390 x 290



19-116
Box
120 x 65 x 13mm
(without Bulldog clamps,
without silicone tape)



19-117
Box with support
120 x 65 x 13 mm
(ohne Bulldogklemmen)



19-118
Box with support for
needle electrodes,
without instruments

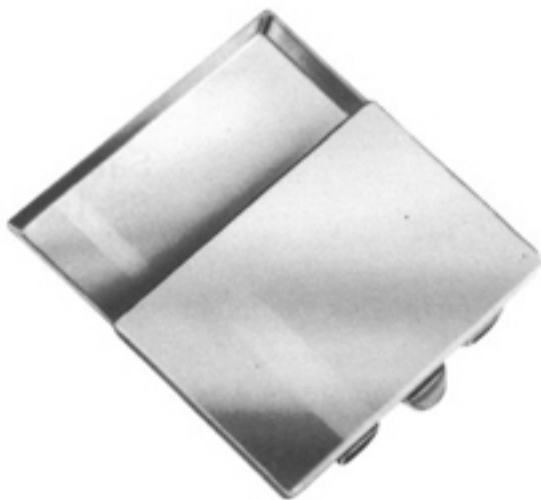

19-119 - 121
50 x 25 x 4,5 mm
19-120
65 x 42 x 8 mm
19-121
75 x 25 x 4,5 mm



19-122
Ø 65mm x 15mm

Hospital Wares



19-123 - 131

	Ø x H
19-123	30 x 90 mm
19-124	50 x 100 mm
19-125	50 x 130 mm
19-126	50 x 175 mm
19-127	75 x 100 mm
19-128	75 x 130 mm
19-129	75 x 175 mm
19-130	100 x 175 mm
19-131	100 x 200 mm



19-141 - 142

- 19-141** Martin Sterilizing Forceps consisting of:
 1 Sterilizing Forceps, curved, 25 cm, without ratchet, with lid for jar
 1 jar with bottom plate (anti-tilt)
- 19-142** ditto, with 32 cm long Sterilizing Forceps



19-132 - 139

19-132	165 x 85 x 35 mm
19-133	200 x 100 x 35 mm
19-134	200 x 100 x 50 mm
19-135	230 x 130 x 50 mm
19-136	260 x 150 x 50 mm
19-137	270 x 235 x 50 mm
19-138	300 x 200 x 50 mm
19-139	325 x 275 x 50 mm



19-140
 205 x 105 x 35 mm

Round Metal Boxes and Medicine Cups



19-143 - 148

	Ø x H
19-143	75 x 60 mm
19-144	75 x 75 mm
19-145	100 x 60 mm
19-146	100 x 100 mm
19-146A	125 x 80 mm
19-147	125 x 125 mm
19-148	150 x 150 mm



19-149
25 cc

19-150
50 cc



19-151
20 cc
Medicine Spoon



19-152
Ø 75 x 12 mm
Tablet Tray



19-153
Ø 90 x 90 mm
Metal Cup



19-154
Ø 75 x 80 mm
Sputum Cup



Kidney Dish



19-155 - 157

19-155	170 x 100 x 35 mm
19-156	250 x 140 x 40 mm
19-157	275 x 150 x 45 mm

Hospital Wares



19-158 - 165

	∅ x H	
19-158	40 x 19 mm	0.05L
19-159	61 x 30 mm	0.07L
19-160	80 x 40 mm	0.14L
19-161	116 x 50 mm	0.35L
19-162	128 x 55 mm	0.45L
19-163	147 x 65 mm	0.70L
19-164	167 x 75 mm	1.10L
19-165	187 x 85 mm	1.60L



19-166 - 170

19-166	116 x 35 mm	0.30L
19-167	128 x 38 mm	0.40L
19-168	147 x 40 mm	0.50L
19-169	157 x 45 mm	0.75L
19-170	187 x 45 mm	1.00L



19-171
∅ 110 x 28 mm 0.15L



19-172
100 cc 0.1L



19-173 - 176
19-173 0,25L
19-174 0,50L
19-175 1,00L
19-176 2,00L



19-177
235 x 190 x 40 mm



19-178
∅ 220 x 70 mm

Hospital Wares



19-179
∅ 50 x 100 mm
Powder Pot



19-180
∅ 50 x 75 mm
Methot With Lid



19-181
∅ 50 x 75 mm
Methot Without Lid



19-182



19-183



19-184

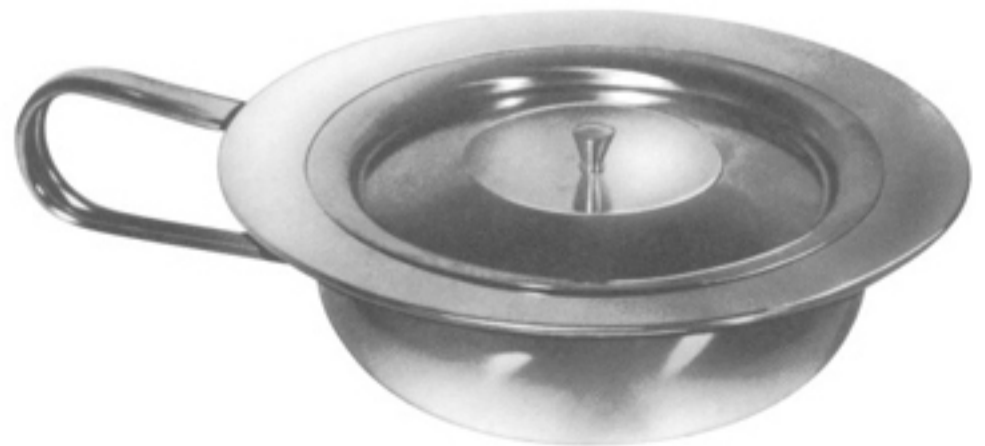

19-185 - 186

19-185 ∅ 235 mm
19-186 ∅ 310 mm

Needle Cases



19-187
Sauerbruch
210 x 125 x 17 mm



19-188
Sauerbruch
210 x 125 x 17 mm



19-189
150 x 95 x 13 mm



19-190
150 x 95 x 13 mm



19-191
150 x 95 x 13 mm



19-192
150 x 95 x 13 mm



19-193
150 x 95 x 13 mm



19-194
150 x 95 x 13 mm



19-195
150 x 95 x 11 mm

Storing Cases



19-199 - 209

19-199	230 x 130 x 50	mm
19-200	260 x 150 x 50	mm
19-201	275 x 235 x 50	mm
19-202	300 x 200 x 50	mm
19-203	325 x 275 x 50	mm
19-204	420 x 175 x 50	mm
19-205	230 x 130 x 75	mm
19-206	260 x 150 x 75	mm
19-207	300 x 200 x 75	mm
19-208	325 x 275 x 75	mm
19-209	420 x 175 x 75	mm



19-196
Deponette
245 x 135 x 35mm



19-197
Deponette
245 x 135 x 50mm



19-198
Deponette
245 x 135 x 60mm

Sterilizing Baskets / Trays



19-210 - 212

19-210	480 x 250 x 50	mm
19-211	520 x 250 x 75	mm
19-212	520 x 250 x 100	mm

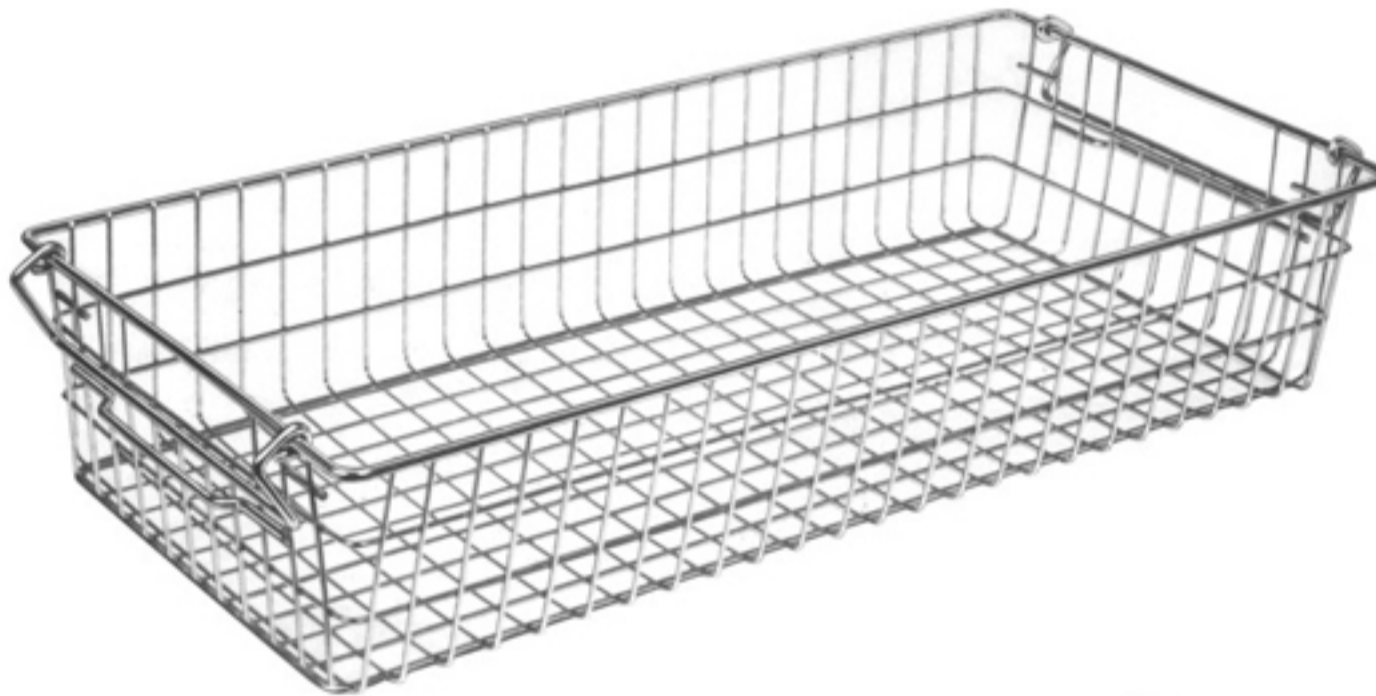

19-219
 (60 x 30 x 15 cm)
 Nominal dimensions

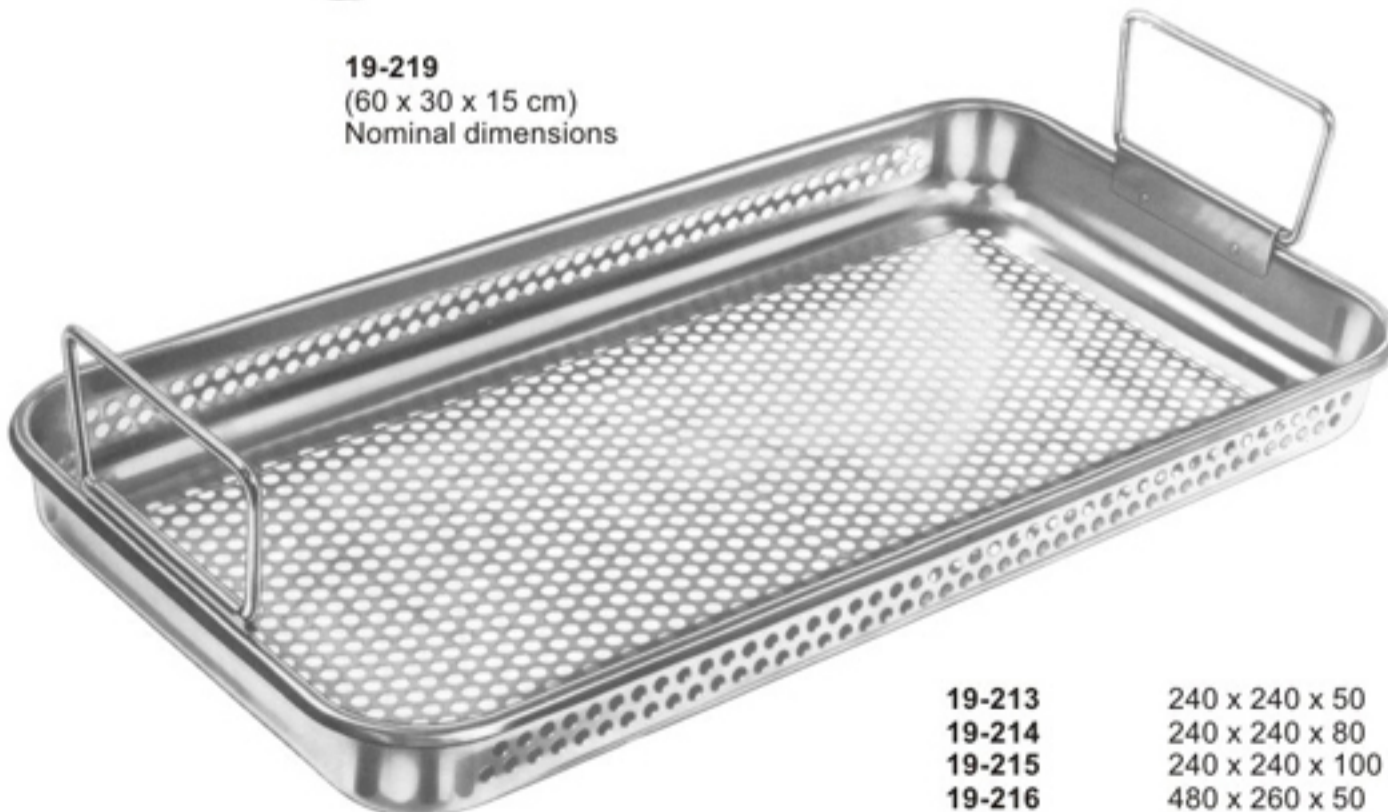

19-213 - 218

19-213	240 x 240 x 50	mm
19-214	240 x 240 x 80	mm
19-215	240 x 240 x 100	mm
19-216	480 x 260 x 50	mm
19-217	520 x 260 x 80	mm
19-218	520 x 260 x 100	mm

Scissors with Tungsten Carbide Inserts

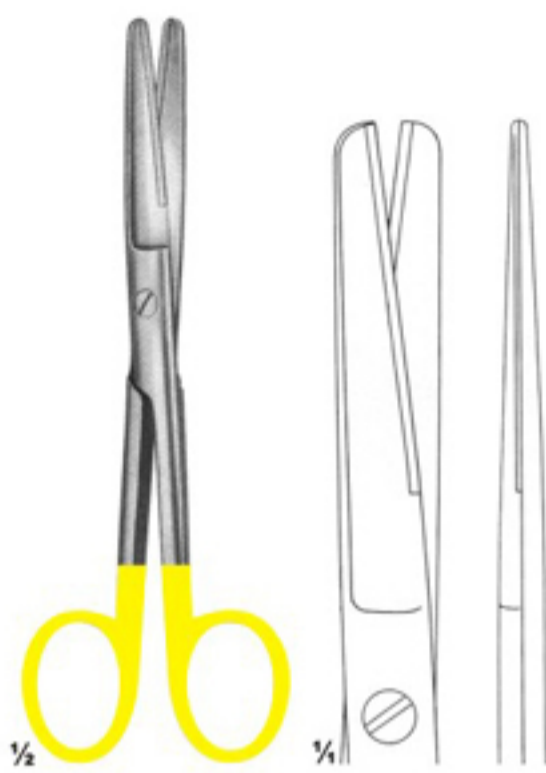

26-101
Standard

14,5cm
16,5cm
18,5cm

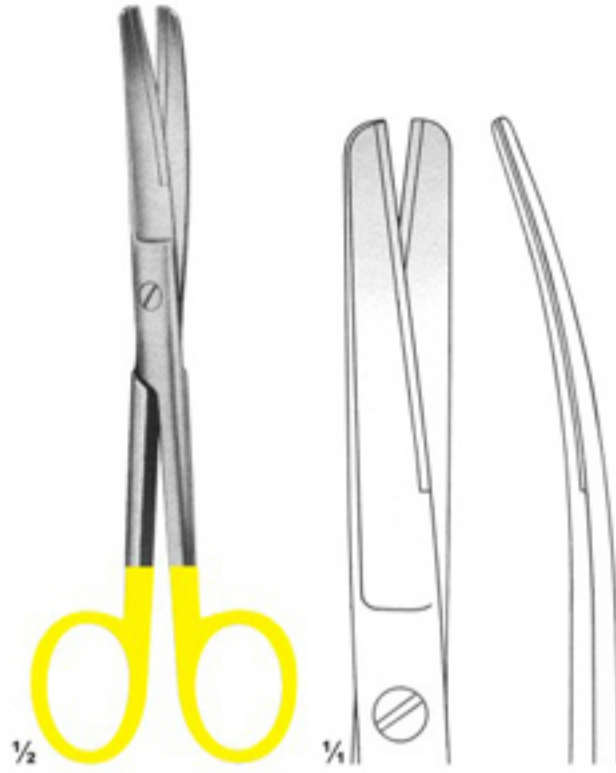

26-102
Standard

14,5cm
16,5cm
18,5cm



26-103
Standard

14,5cm
16,5cm
18,5cm

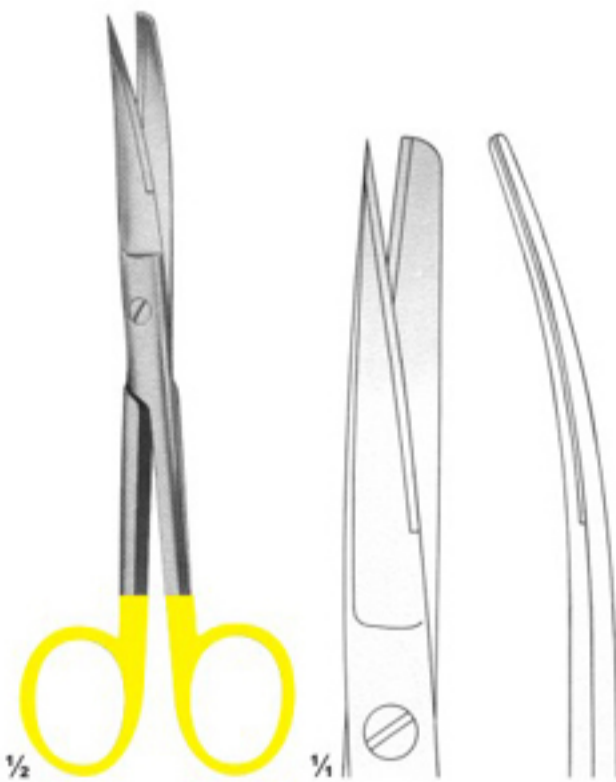

26-104
Standard

14,5cm
16,5cm
18,5cm

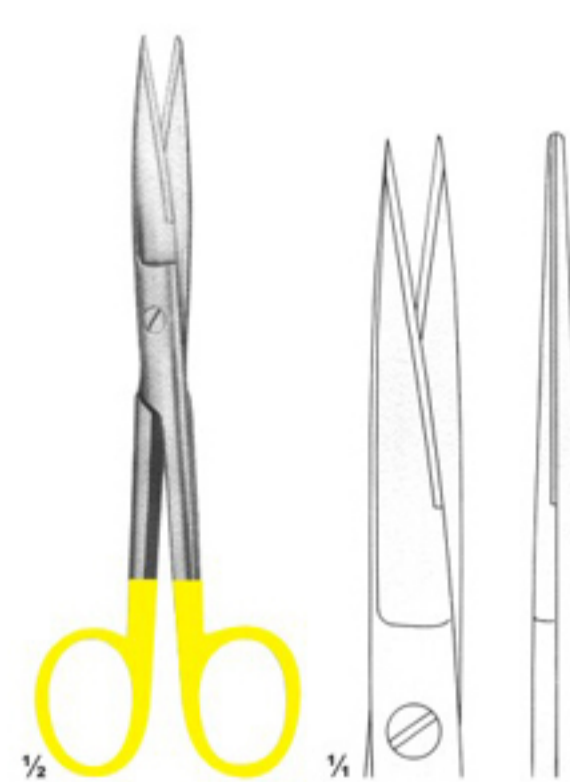

26-105
Standard

14,5cm
16,5cm
18,5cm



26-106
Standard

14,5cm
16,5cm
18,5cm

Scissors with Tungsten Carbide Inserts

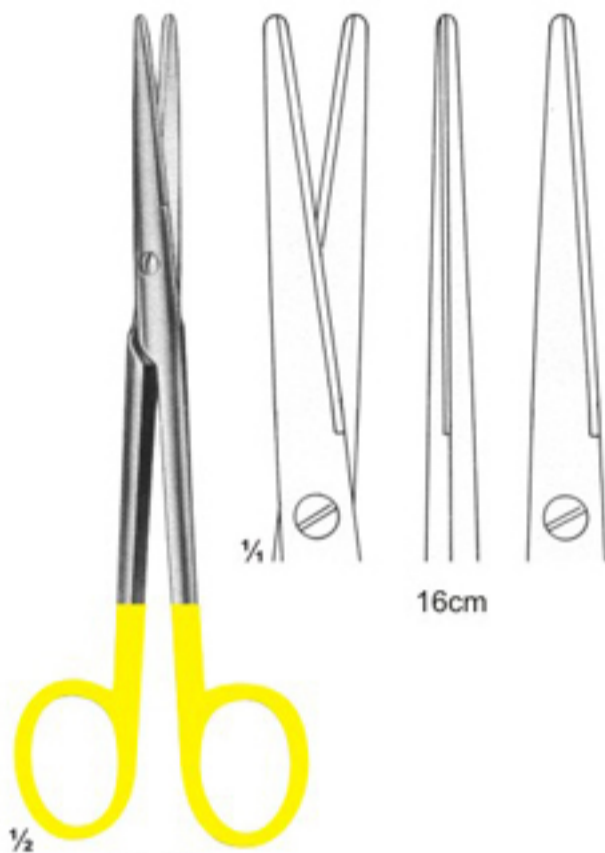

26-107
Mayo-Lexer

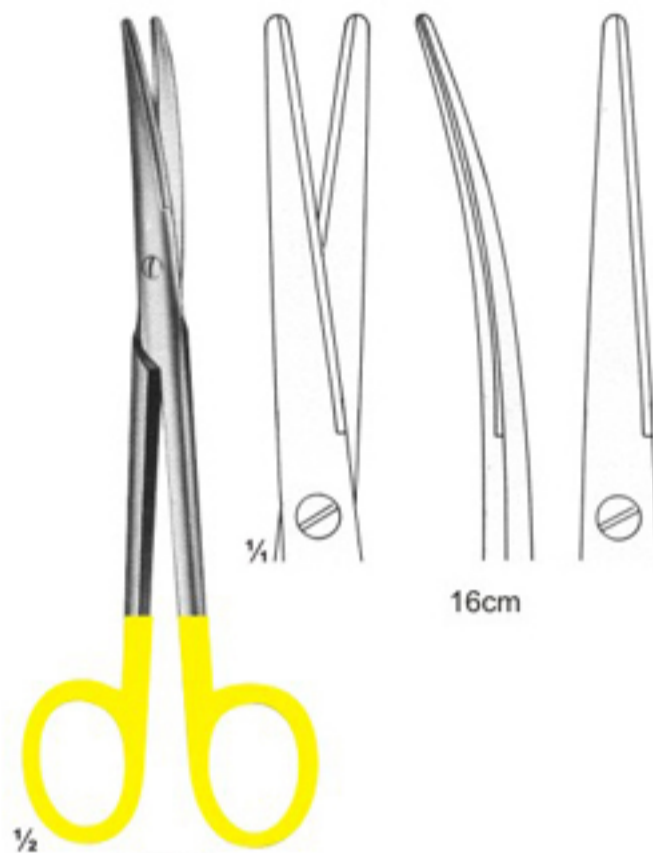

26-108
Mayo-Lexer

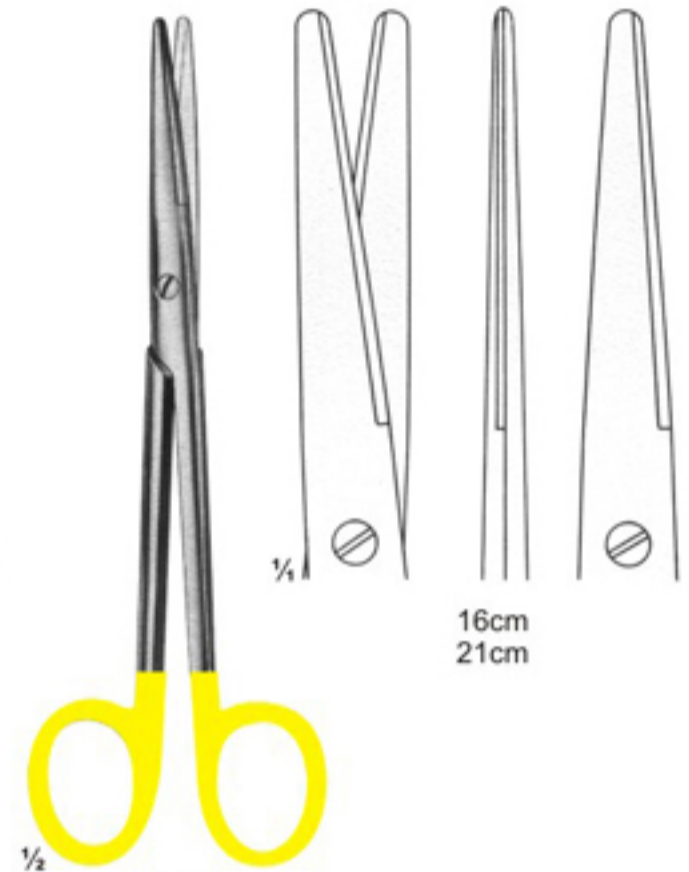

26-109
Lexer

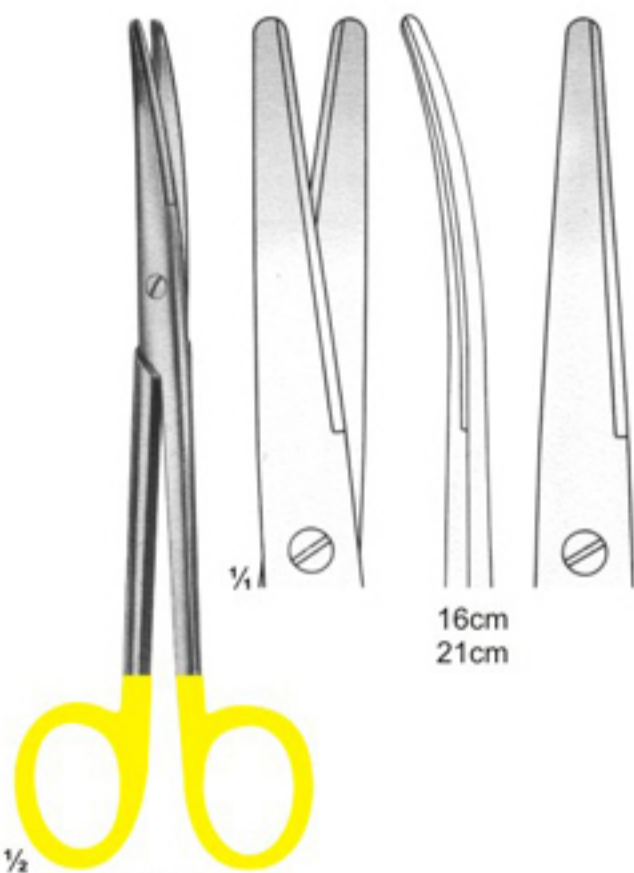

26-110
Lexer

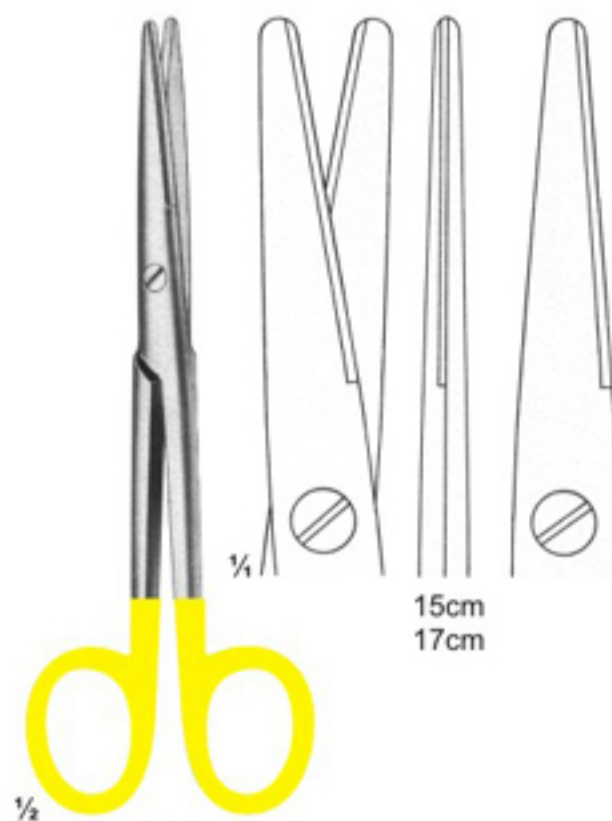

26-111
Mayo-Stille

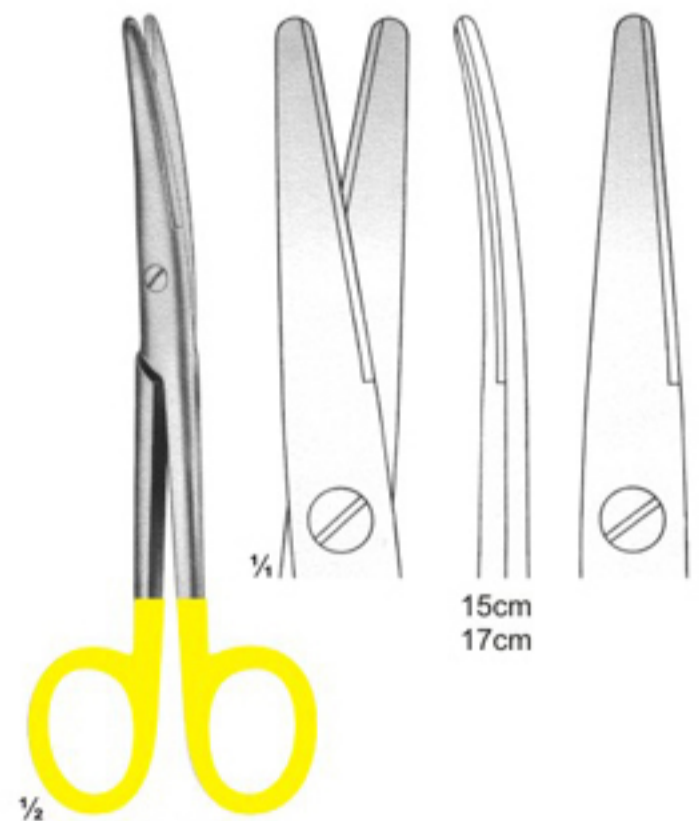

26-112
Mayo-Stille

Scissors with Tungsten Carbide Inserts

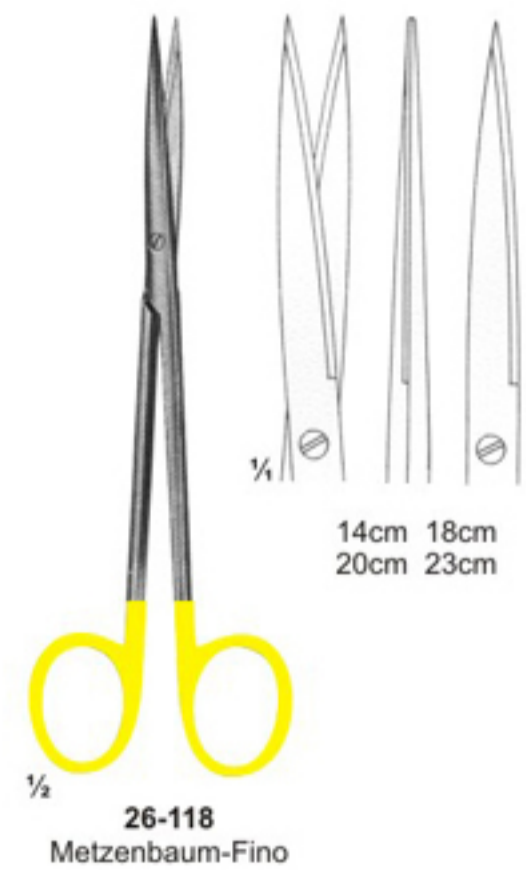
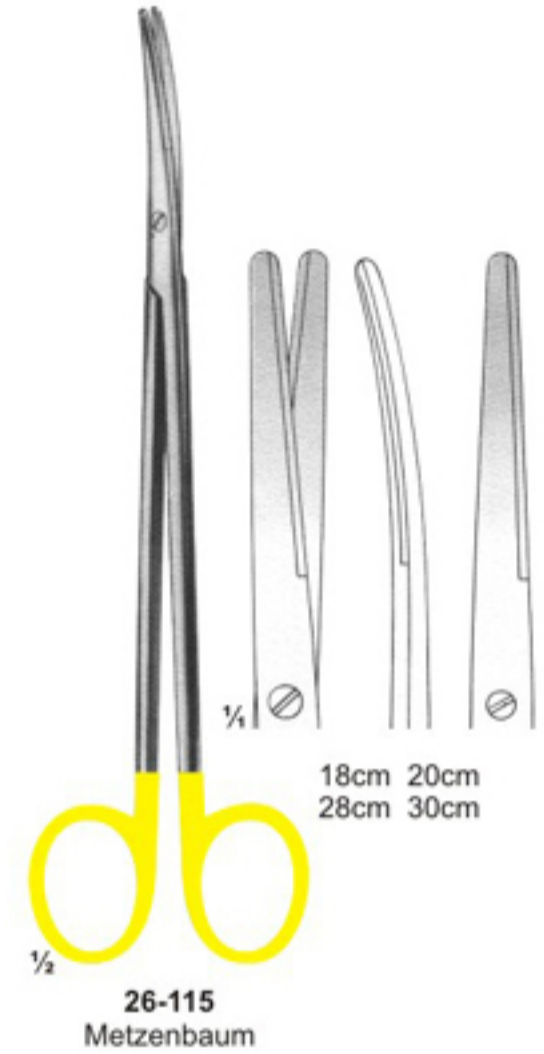
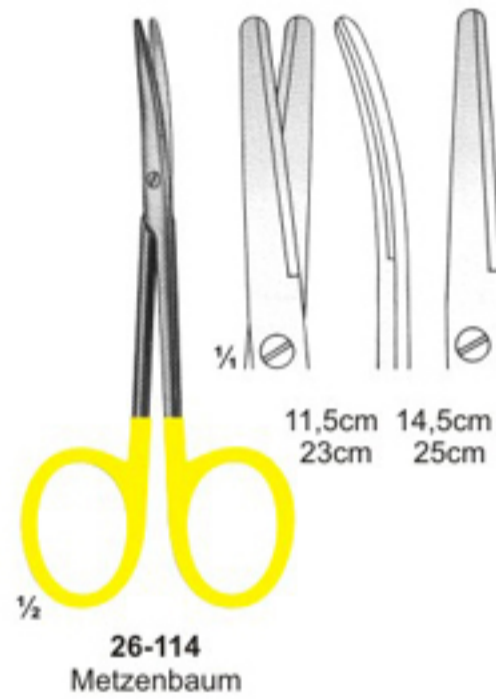
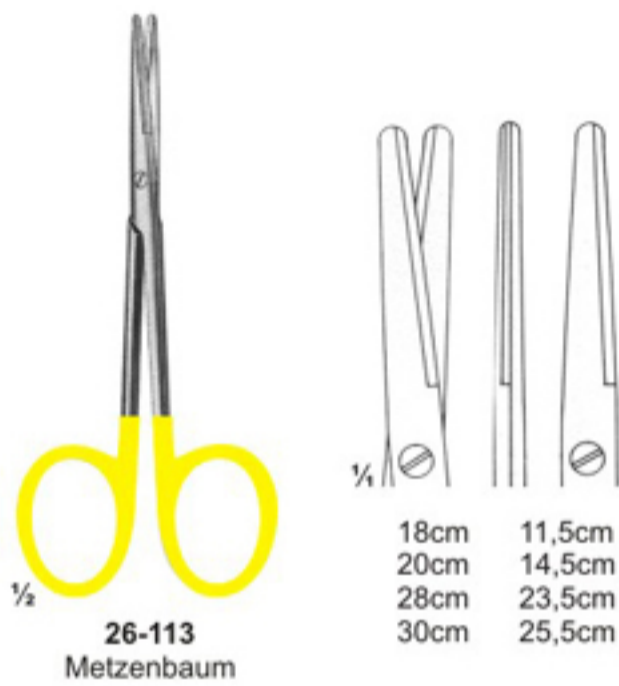

Scissors with Tungsten Carbide Inserts

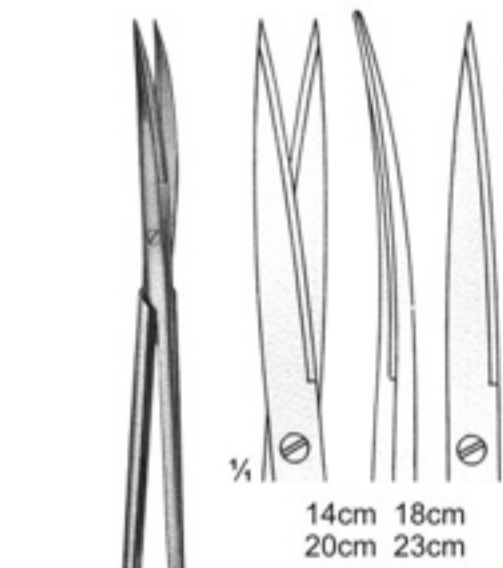

$\frac{1}{2}$
26-119
Metzenbaum-Fino

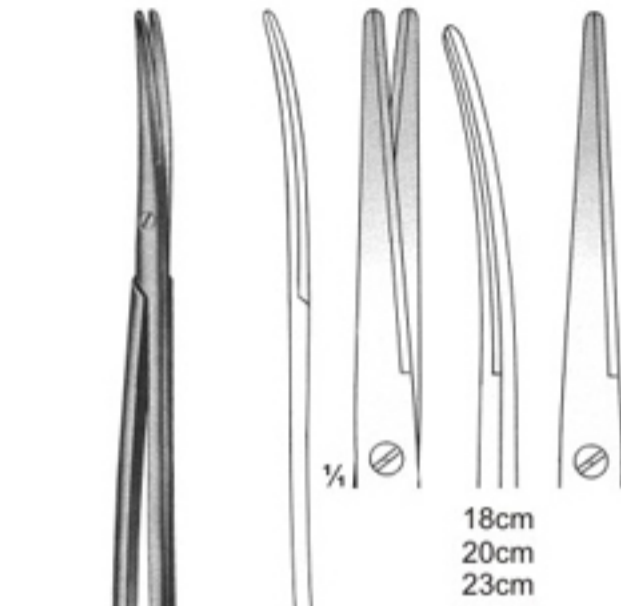

$\frac{1}{2}$
26-120
Metzenbaum-Fino

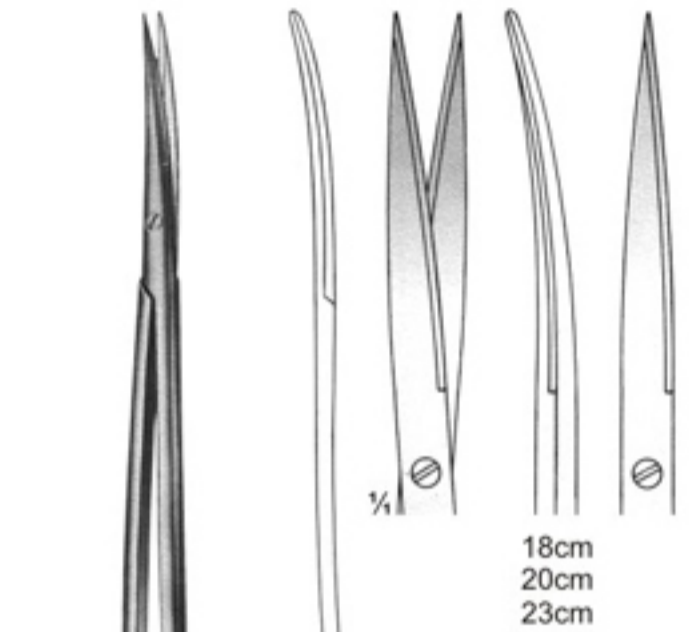

$\frac{1}{2}$
26-121
Metzenbaum-Fino

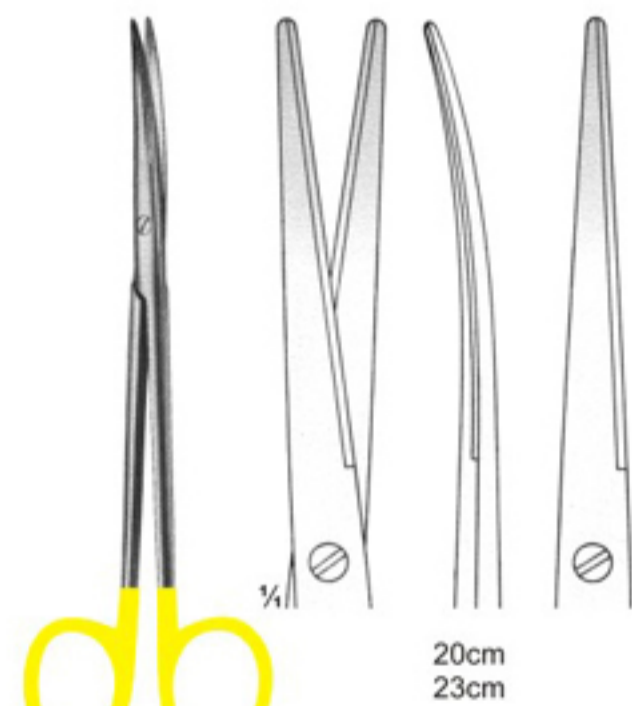

$\frac{1}{2}$
26-122
Metzenbaum

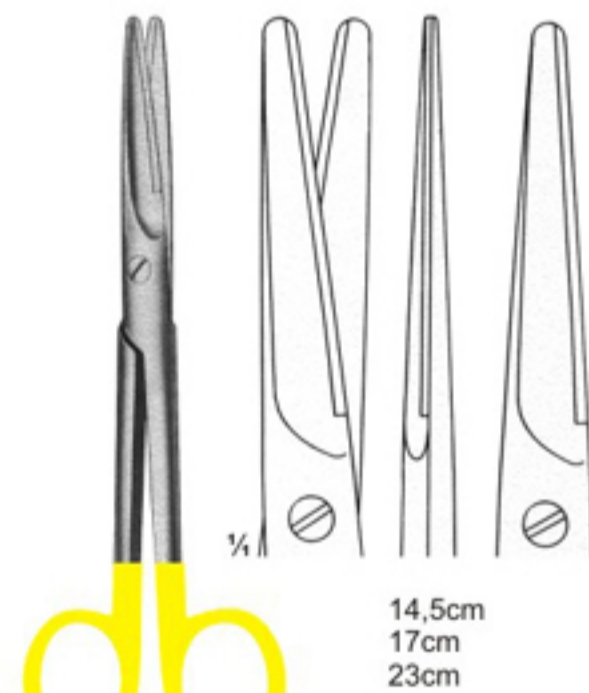

$\frac{1}{2}$
26-123
Mayo

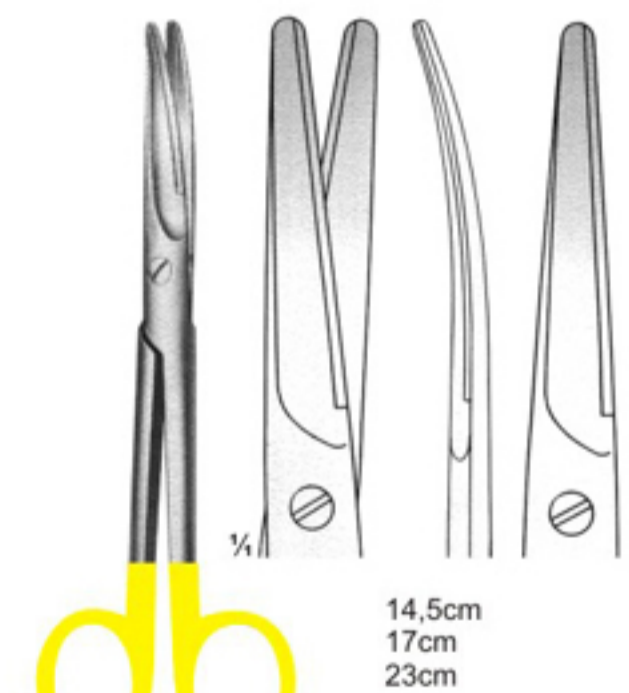

$\frac{1}{2}$
26-124
Mayo

Scissors with Tungsten Carbide Inserts

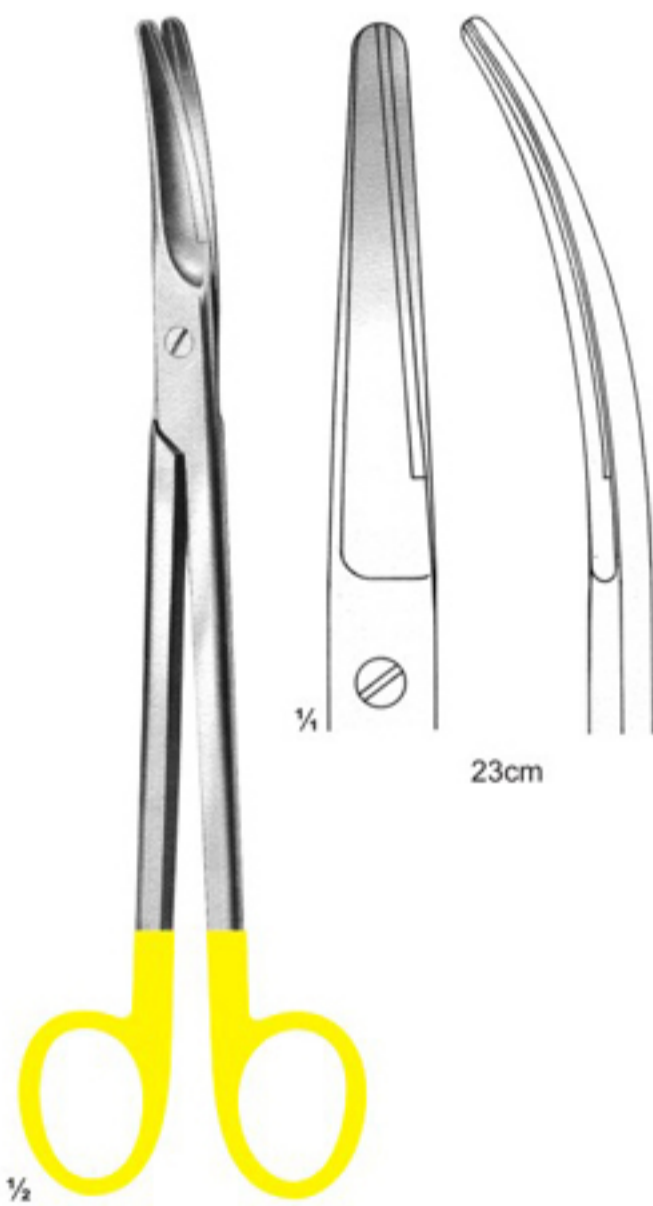

26-125
Parametrium

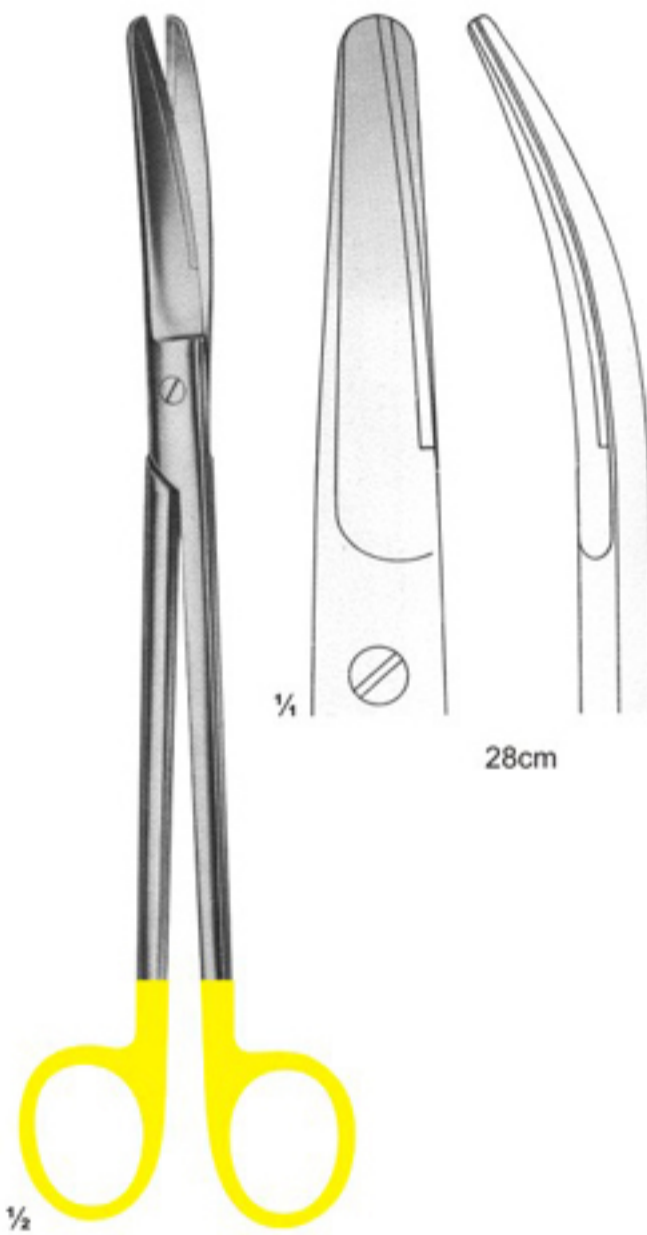

26-126
Mayo-Harrington

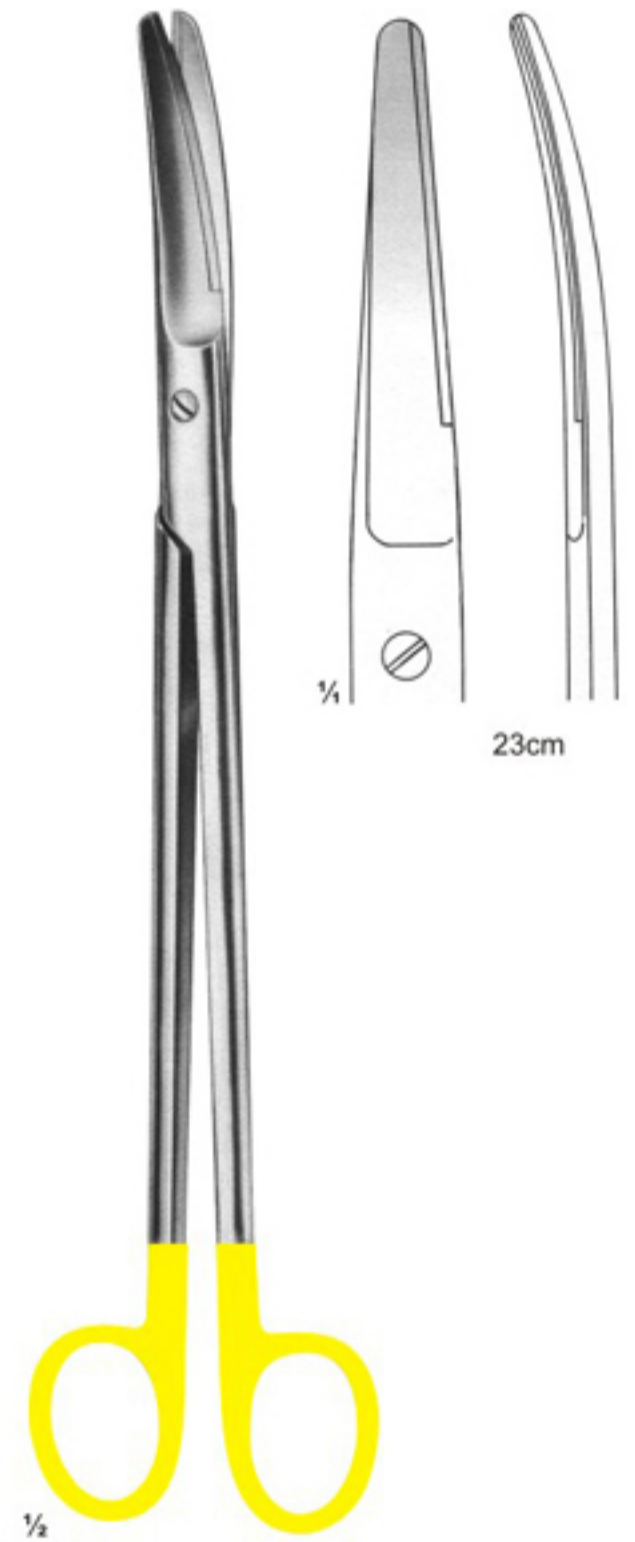

26-127
Sims

Scissors with Tungsten Carbide Inserts

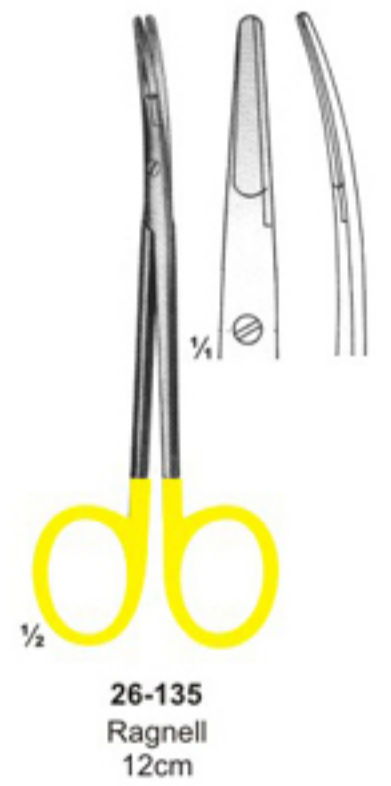
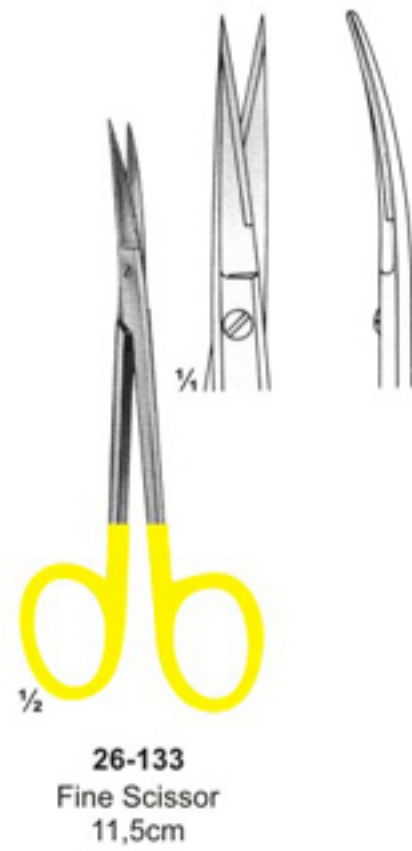
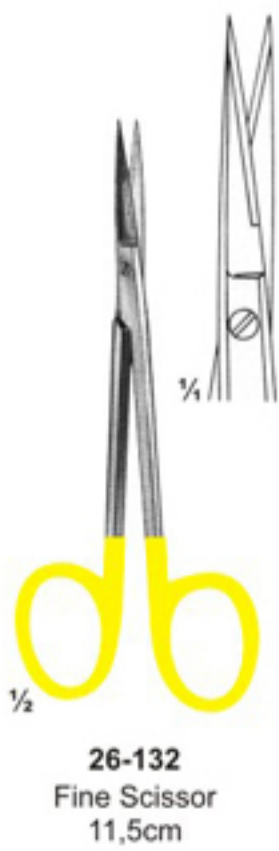
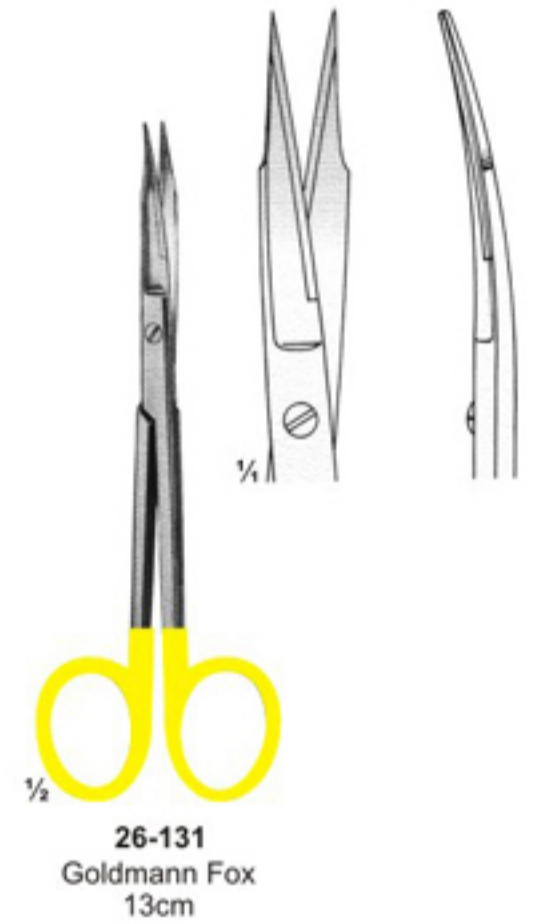
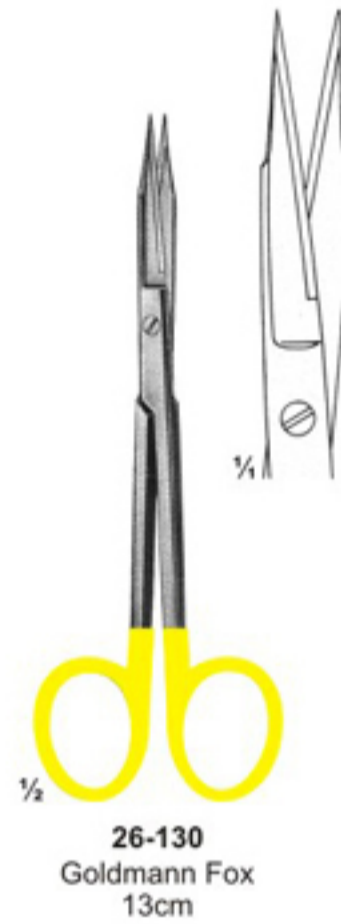
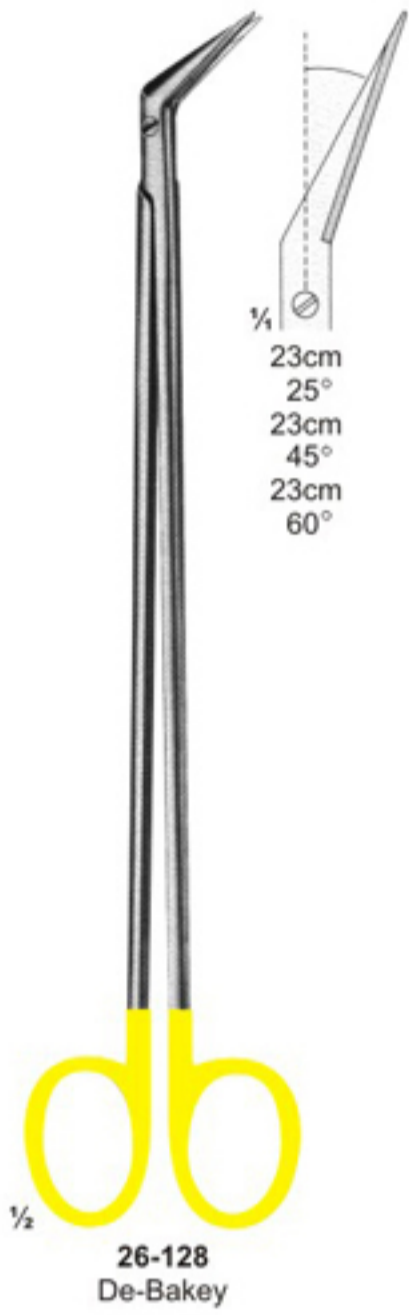

Scissors & Dissecting Forceps with Tungsten Carbide Inserts

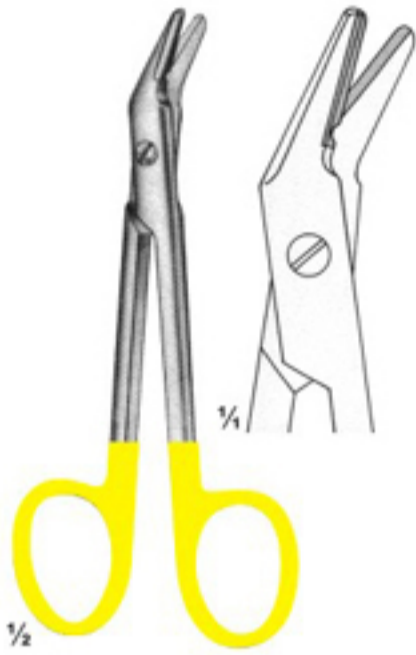

26-136
Universal
12cm

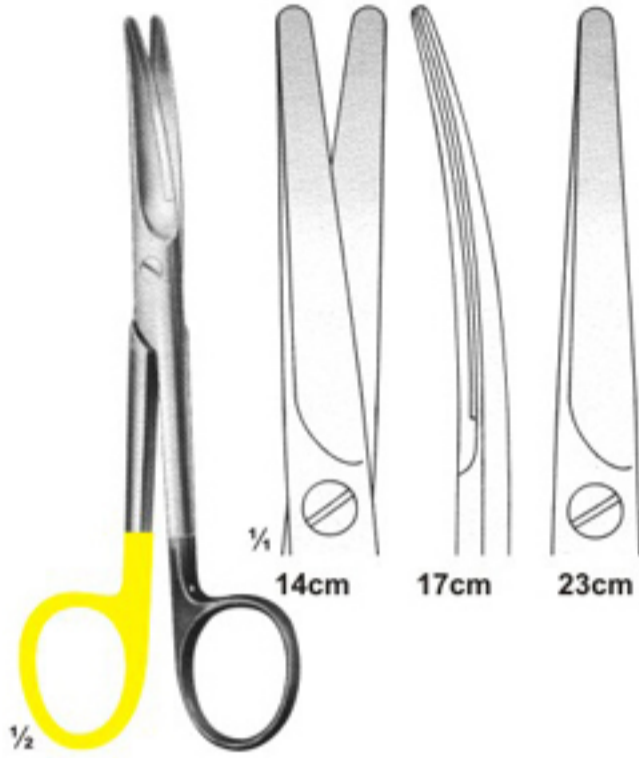

26-137
Ligature Scissors
1 Black & 1 Goldplated ring

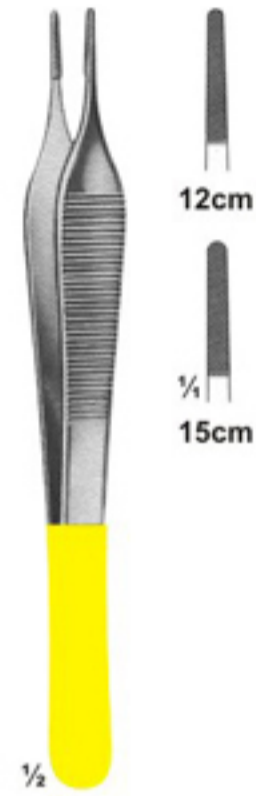

26-138
Adson



26-139
Cushing
17,5cm



26-140
Cushing
18cm



26-141
Cushing-Taylor
18cm



26-142
Dissecting Forceps
15cm



26-143
Semken
15cm

Dissecting Forceps and Needle holders with

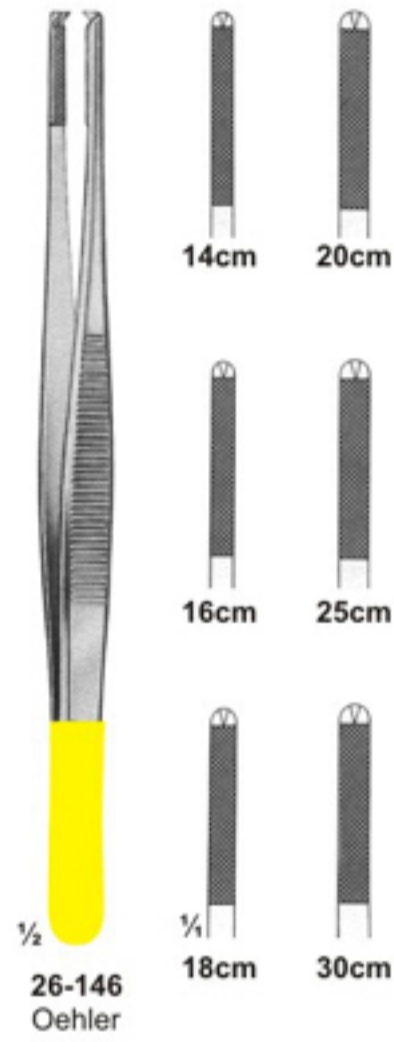
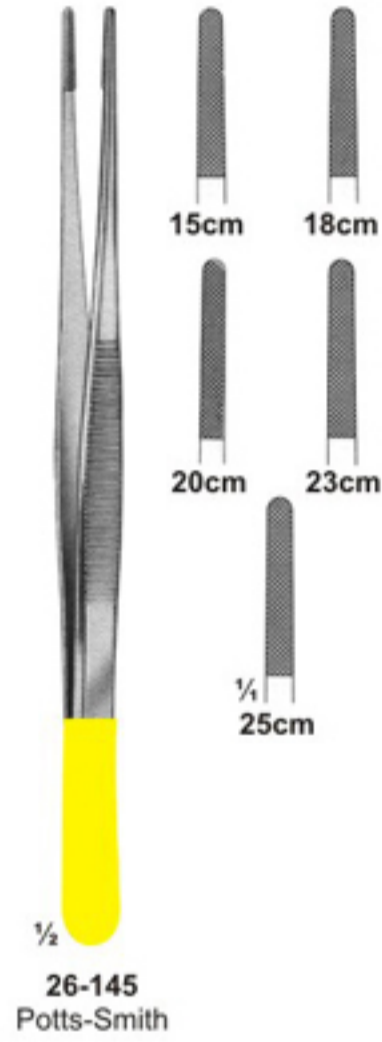
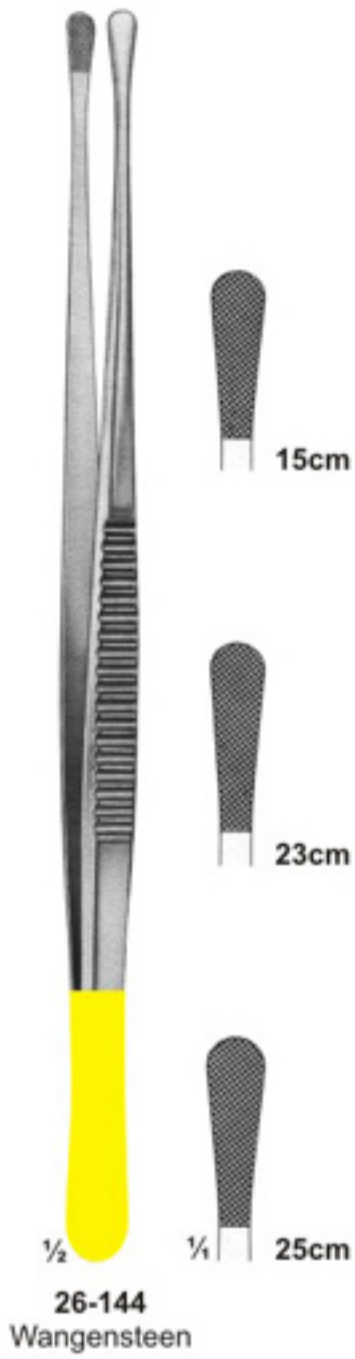

Needle holders with Tungsten Carbide Inserts



26-152
Arruga
16cm



26-153
Castroviejo
13cm

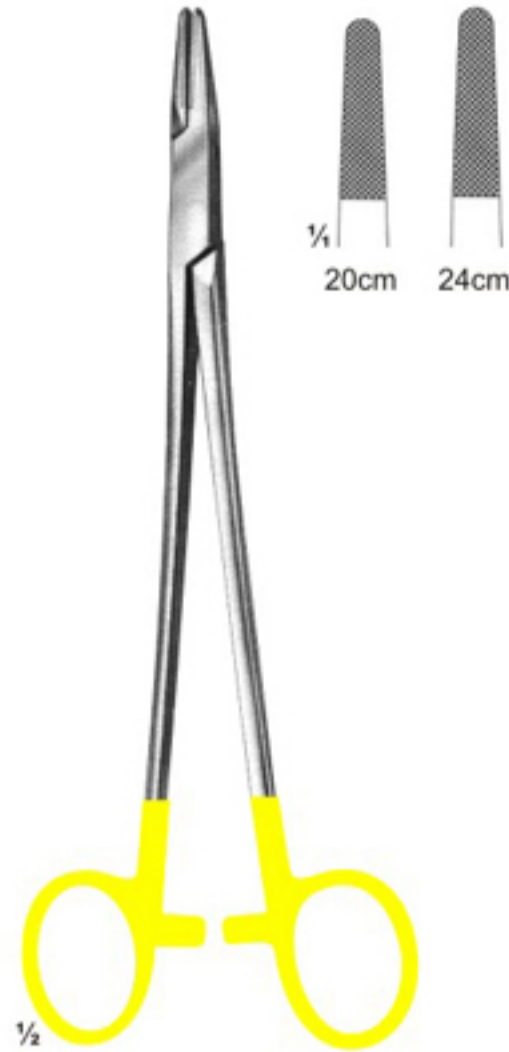

26-154
Hegar
20cm 24cm

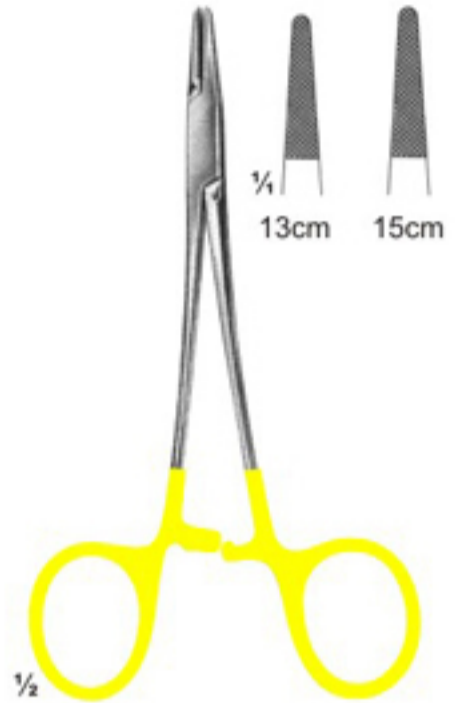

26-155
Halsey
13cm 15cm



26-156
Mayo-Hegar
16cm 18cm 20cm
24cm 26cm 30cm

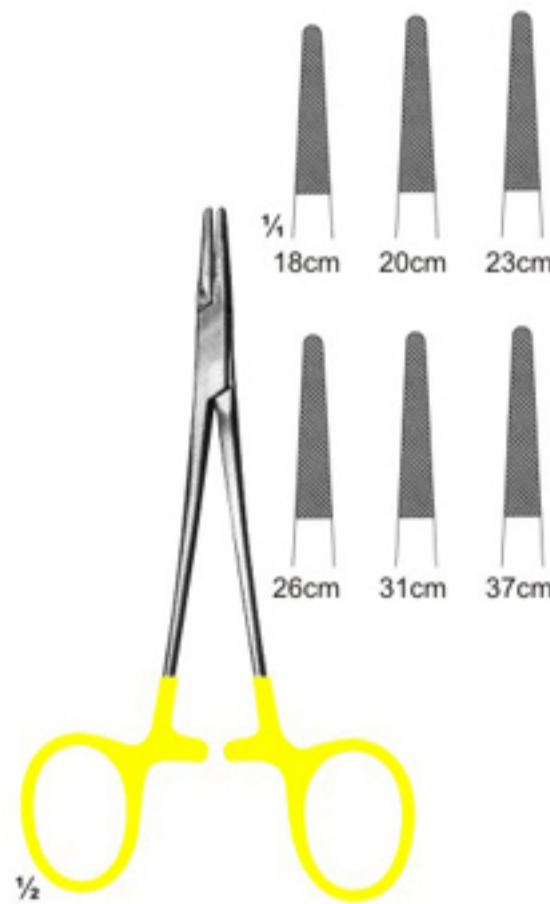

26-157
De-Bakey
18cm 20cm 23cm
26cm 31cm 37cm

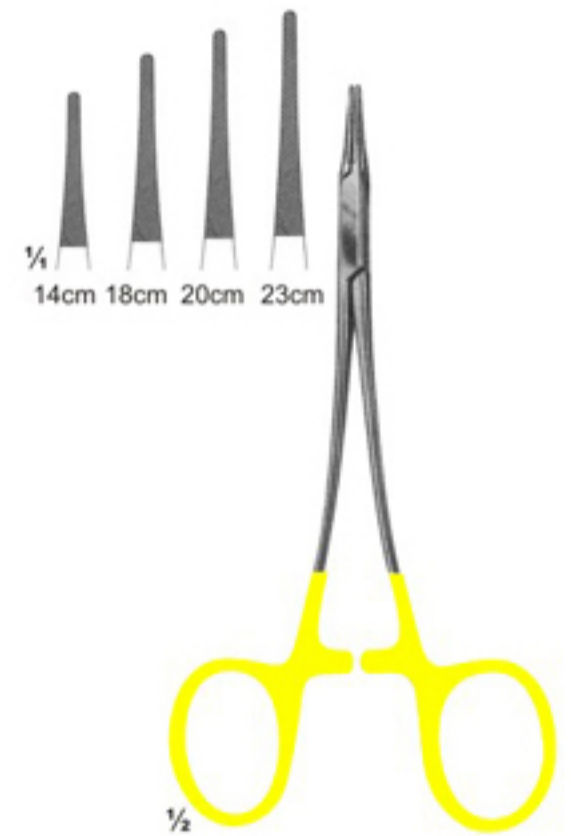

26-158
Hegar-Vascular
14cm 18cm
20cm 23cm

Needle holders with Tungsten Carbide Inserts



$\frac{1}{2}$
26-159
Bozemann-Wertheim
20cm 24cm 26cm



$\frac{1}{2}$
26-160
Stratte
22cm 23cm

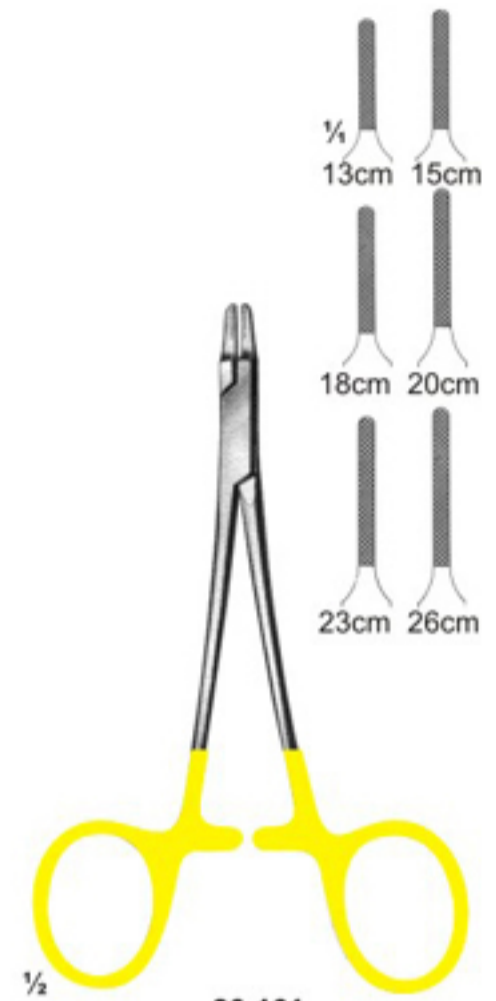

$\frac{1}{2}$
26-161
Ryder
13cm 15cm 18cm
20cm 23cm 26cm



$\frac{1}{2}$
26-162
Ryder-Vascular
13cm 15cm 18cm
20cm 23cm 26cm



$\frac{1}{2}$
26-163
Martin
15cm 17cm 20cm

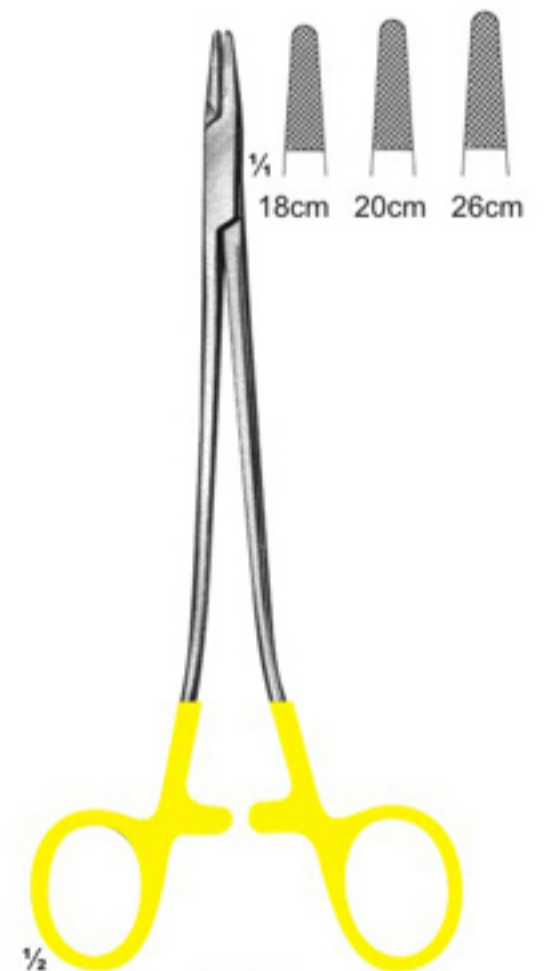

$\frac{1}{2}$
26-164
Sarot
18cm 20cm 26cm

Needle holders with Tungsten Carbide Inserts



Needle holders with Tungsten Carbide Inserts



1/2
26-172
Mathieu-Ryder
17cm
20cm 24cm



1/2
26-173
Lichtenberg
20cm



1/2
26-174
Langhals
20cm 25cm



1/2
26-175
Lichtenberg
20cm 25cm



1/2
26-176
Luehty-Beck
20cm 25cm



1/2
26-177
Luehty-Beck
20cm 25cm



1/2
26-178
Langebeck
18cm
20cm 23cm

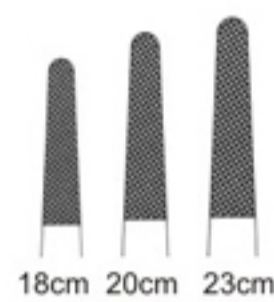

1/2
26-179
Langebeck-beck
18cm
20cm 23cm

Wire Cutting Plier With T.C. Inserts



26-180
TOENNIS
Elastic pattern for
dura-or intestinal suture
180 mm



26-181
Cutting Plier
12 cm

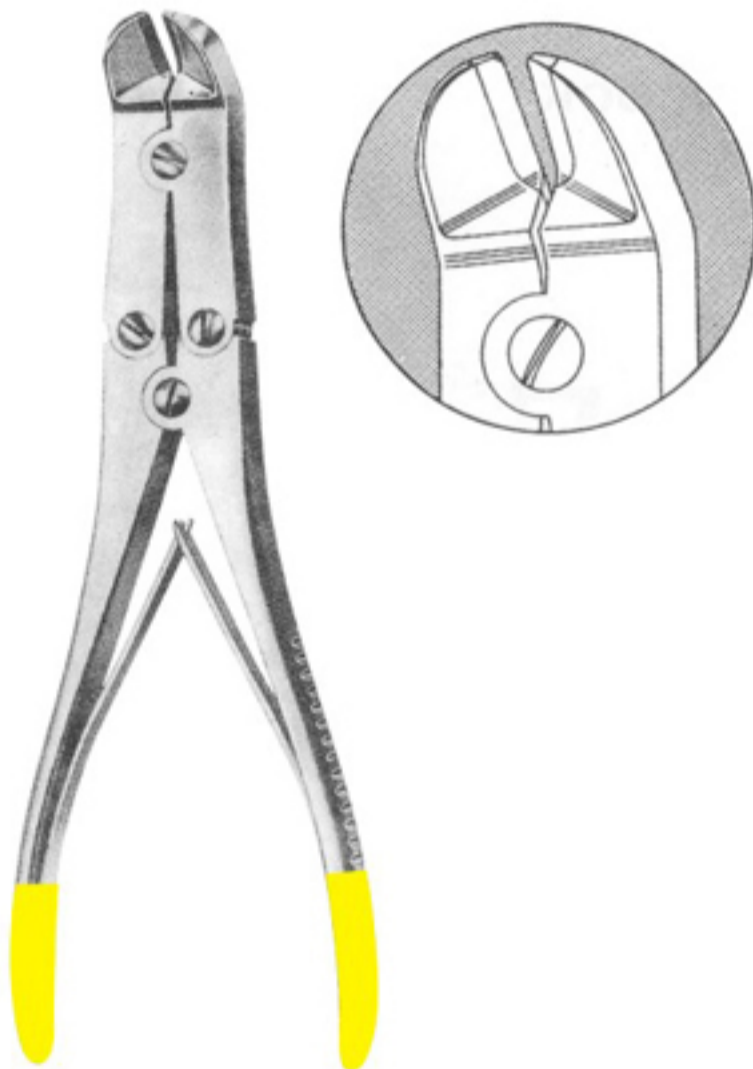

26-182
MULLAR CLAUS
22 cm



26-183
Plier
17.5 cm



Shahabpura Road Near Tajdare Madina Masque

Email: info@exponiqsurgical.com

Email: +92-052-3242143